

Built-in temperature compensation diodes
Built-in emitter resistor
Darlington

SAP16N

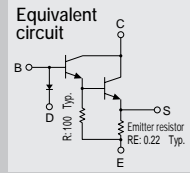

(Complement to type SAP16P)

Application: Audio

■ Absolute maximum ratings ($T_a=25^\circ\text{C}$)

Symbol	Ratings	Unit
V_{CB0}	160	V
V_{CEO}	160	V
V_{EBO}	5	V
I_C	15	A
I_B	1	A
P_C	150 ($T_c=25^\circ\text{C}$)	W
$D_i I_F$	10	mA
T_J	150	$^\circ\text{C}$
T_{stg}	-40 to +150	$^\circ\text{C}$

■ Electrical Characteristics ($T_a=25^\circ\text{C}$)

Symbol	Conditions	Ratings			Unit
		min	typ	max	
I_{CBO}	$V_{CB}=160\text{V}$			100	μA
I_{EBO}	$V_{EB}=5\text{V}$			100	μA
V_{CEO}	$I_C=30\text{mA}$	160			V
h_{FE}^*	$V_{CE}=4\text{V}, I_C=10\text{A}$	5000		20000	
$V_{CE(sat)}$	$I_C=10\text{A}, I_B=10\text{mA}$			2.0	V
$V_{BE(sat)}$	$I_C=10\text{A}, I_B=10\text{mA}$			2.5	V
V_{BE}	$V_{CE}=20\text{V}, I_C=40\text{mA}$		1190		mV
$D_i V_F$	$I_F=2.5\text{mA}$		705		mV
R_E	$I_E=1\text{A}$	0.176	0.22	0.264	Ω
R_{EB}		90	100	110	Ω

* h_{FE} Rank \bar{O} (5000 to 12000), Y (8000 to 20000)

External Dimensions

(Unit: mm)

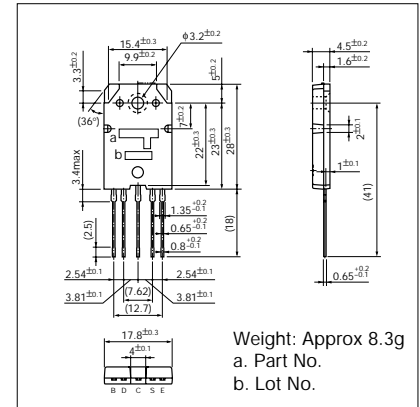

$I_C - V_{CE}$ Characteristics (Typical)

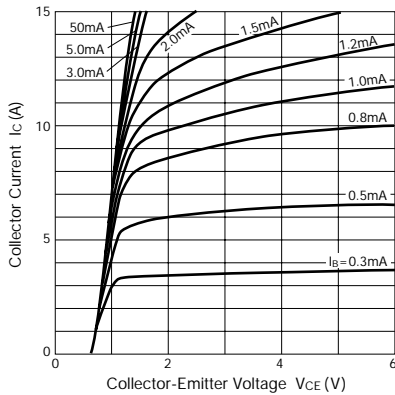

$V_{CE(sat)} - I_B$ Characteristics (Typical)

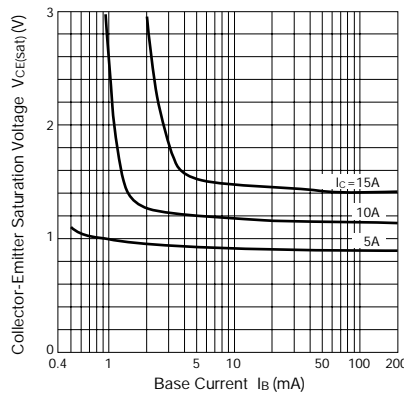

$I_C - V_{BE}$ Temperature Characteristics (Typical)

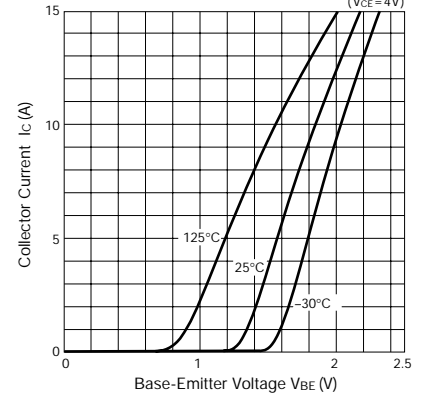

$h_{FE} - I_C$ Characteristics (Typical)

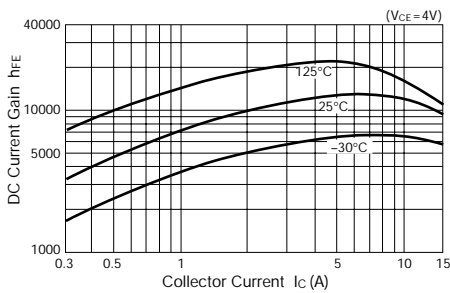

$\theta_{j-a} - t$ Characteristics

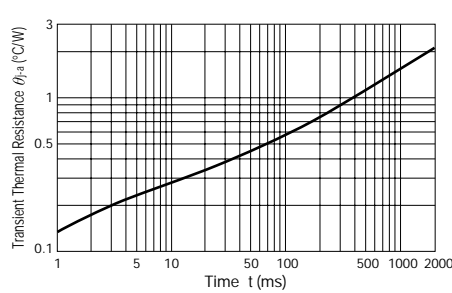

Safe Operating Area (Single Pulse)

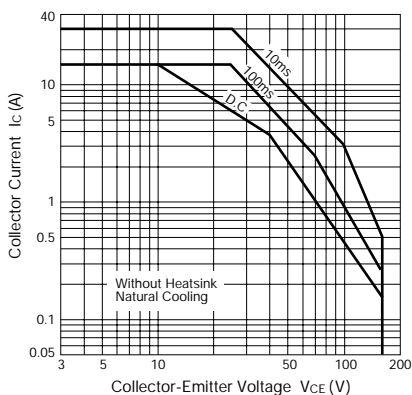

$D_i I_F - V_F$ Characteristics (Typical)

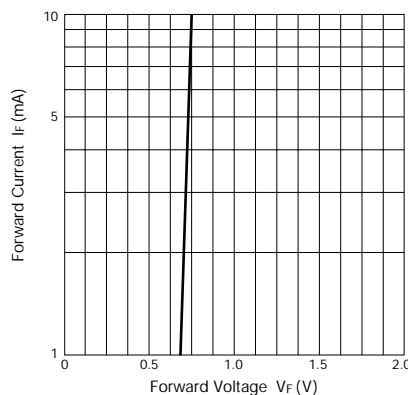

$P_C - T_a$ Derating

