

ST16C650

ST16C650

BLOCK DIAGRAM

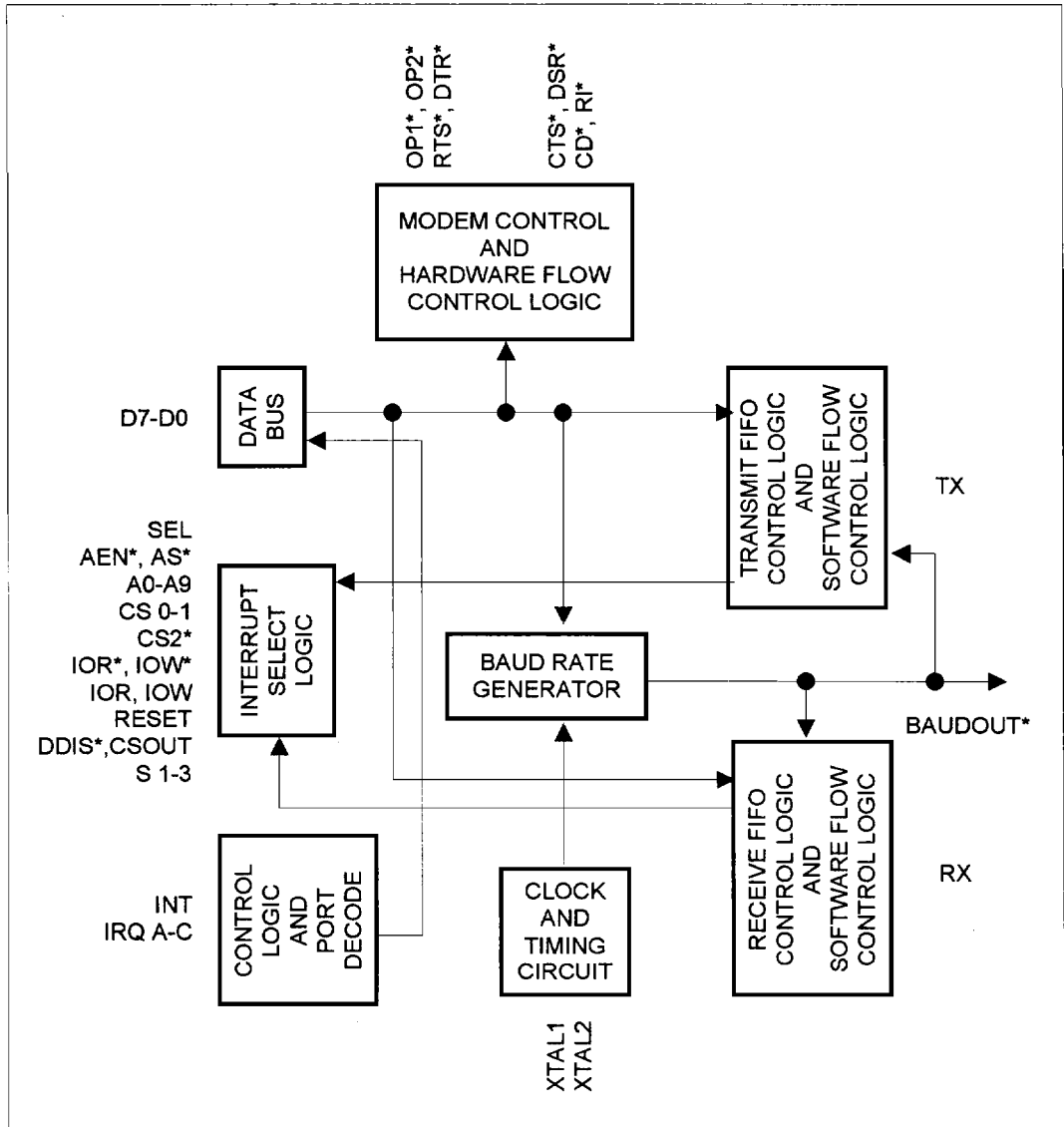

SYMBOL DESCRIPTION

Symbol	Pin	Signal Type	Pin Description
A9	1	I	Address select line 9. When PC mode is selected, this pin is used as 10th address line to decode the standard COM1-4 ports.
D0-D7	2-9	I/O	Bi-directional data bus. Eight bit, three state data bus to transfer information to or from the CPU. D0 is the least significant bit of the data bus and the first serial data bit to be received or transmitted.
S2/RCLK	10	I	Port select-2 or Receive clock input (dual function). When PC mode is selected the RCLK input is connected internally to BAUDOUT* output pin and S2 is used to select one of the ComPort addresses (Com1-4). During STD mode operation, this pin is used as external clock input to the ST16C650 receiver section.
RX	11	I	Serial data input. The serial information (data) received from serial port to ST16C650 receive input circuit. A mark (high) is logic one and a space (low) is logic zero. During the local loop-back mode the RX input is disabled from external connection and connected to the TX output internally.
A4	12	I	Address select line 4. When PC mode is selected, this pin is used as 5th address line to decode the standard COM1-4 ports.
TX	13	O	Serial data output. The serial data is transmitted via this pin with additional start, stop and parity bits. The TX will be held in mark (high) state during reset, local loop-back mode or when the transmitter is disabled.
A5/CS0	14	I	Address line 5 or Chip select-1 (dual function). During the PC mode operation, this pin is used as 6th address line to decode the standard COM1-4 ports. During STD mode this pin acts as active high chip select input pin.
A6/CS1	15	I	Address line 6 or Chip select-2 (dual function). During the PC mode operation, this pin is used as 7th address line to decode the standard COM1-4 ports. During STD mode this pin acts as active high chip select input pin.

ST16C650

ST16C650

SYMBOL DESCRIPTION

Symbol	Pin	Signal Type	Pin Description
A7/CS2*	16	I	Address line 7 or Chip select -3 (dual function). During the PC mode operation, this pin is used as 8th address line to decode the standard COM1-4 ports. During STD mode this pin acts as active low chip select input pin.
BAUD/LPT1*	17	O	Baud rate generator clock output or LPT1 decode address (378 Hex) (dual function). This output provides the 16X clock of the internal selected baud rate during standard mode. RCLK pin is connected externally to BAUDOUT* pin to provide receive clock when STD mode is selected. This pin internally is connected to RCLK input and address 378 Hex is decoded when PC mode is selected.
XTAL1	18	I	Crystal input 1 or external clock input. A crystal can be connected to this pin and XTAL2 pin to utilize the internal oscillator circuit. An external clock can be used to clock internal circuit and baud rate generator for custom transmission rates.
XTAL2	19	I	Crystal input 2 or buffered clock output. See XTAL1. External 1 MΩ resistor is required to connect between XTAL1 and XTAL2 pins.
IOW*	20	I	Write strobe. (active low) A low on this pin will transfer the contents of the CPU data bus to the addressed register.
A8/IOW	21	I	Address 8 or Write strobe (dual function). During the PC mode operation, this pin is used as 9th address line to decode the standard COM1-4 ports. During STD mode this pin functions as Write strobe (active high). Same as IOW*, but uses active high input. Note that only an active IOW* or IOW input is required to transfer data from CPU to ST16C650 during write operation.
GND	22	O	Signal and power ground.
S1	23	I	Port select-1. S1 is used to select one of the ComPort addresses (Com1-4).
IOR*	24	I	Read strobe. (active low) A low level on this pin transfers the contents of the ST16C650 data bus to the CPU.

SYMBOL DESCRIPTION

Symbol	Pin	Signal Type	Pin Description
A3/IOR	25	I	Address line 3 or Read strobe (dual function). When PC mode is selected, this pin is used as 4th address line to decode the standard COM1-4 ports. During STD mode operation this pin is used as Read strobe. Same as IOR*, but it is used as active high Read strobe. Note that only an active IOR* or IOR input is required to transfer data from ST16C650 to CPU during read operation.
DDIS*/LPT2*	26	O	Drive disable or LPT2 decoded address (278 Hex) (dual function). (active low) This pin goes low when the CPU is reading data from the ST16C650 to disable the external transceiver or logic's during STD mode. During PC mode, LPT2 address is decoded.
IRQC/TXRDY	27	O	IRQ-C Interrupt (three state) or Transmit ready (dual function). Three state interrupt output during PC mode and Transmit ready during STD mode. When STD mode is selected this pin goes high when the transmit FIFO of the ST16C650 is full. See INTA/INT description for IRQ-C operation.
AEN*/AS*	28	I	Address enable or Address strobe (dual function). During PC mode operation Valid COM 1-4 ports are decoded when this pin goes low. A low on this pin During STD mode latches the state of the chip selects and addressed register (A2-A0). This input is used when signals are not stable for the duration of a read or write operation. If not required, tie the AS* input permanently low.
A2	29	I	Address select line 2. To select internal registers.
A1	30	I	Address select line 1. To select internal registers.
A0	31	I	Address select line 0. To select internal registers.
IRQB/RXRDY*	32	O	IRQ-B Interrupt (three state) or Receive ready (dual function). Three state interrupt output during PC mode and Receive ready during STD mode. During the STD mode operation this pin goes low when the receive FIFO is full. See INTA/INT description for IRQ-B operation.

ST16C650

ST16C650

SYMBOL DESCRIPTION

Symbol	Pin	Signal Type	Pin Description
IRQA/INT	33	O	IRQ-A Interrupt (normal, three state or open source) or Interrupt output (triple function active high). During PC mode operation, this pin is activated when MCR Bit-3 is set to "1" and enabled by the interrupt enable register. whenever a receiver error, receiver data available, transmitter empty, or modem status condition flag is detected. During the STD mode operation three state mode is disabled and functions as active IRQ-A. Multiple ST16C650 interrupts can be connected to form a wired "Ored" function by setting the MCR bit-5 to "1" and connecting a 450 Ω resistor to ground.
SEL	34	I	Mode select (pulled-up). PC mode is selected by tying this pin to GND and STD mode is selected when this pin is left open or tied to VCC.
S3/OP2*	35	I/O	Select-3 or User defined output (dual function). ComPort address select 1-4 when PC mode is selected and general purpose output when STD mode is selected. See bit-3 modem control register (MCR bit-3).
RTS*	36	O	Request to send. (active low) To indicate that the transmitter has data ready to send. Writing a "1" in the modem control register (MCR bit-1) will set this pin to a low state. After the reset this pin will be set to high. Note that this pin does not have any effect on the transmit or receive operation it is not enabled via EFR Bit-6.
DTR*	37	O	Data terminal ready. (active low) To indicate that ST16C650 is ready to receive data. This pin can be controlled via the modem control register (MCR bit-0). Writing a "1" at the MCR bit-0 will set the DTR* output to low. This pin will be set to high state after writing a "0" to that register or after the reset . Note that this pin does not have any effect on the transmit or receive operation.
OP1*	38	O	User defined output. See bit-2 of modem control register (MCR bit-2).
RESET	39	I	Master reset. (active high) A high on this pin will reset all the outputs and internal registers. The transmitter output and

SYMBOL DESCRIPTION

Symbol	Pin	Signal Type	Pin Description
CTS*	40	I	the receiver input will be disabled during reset time. Clear to send. (active low) The CTS* signal is a MODEM control function input whose conditions can be tested by reading the MSR BIT-4. CTS* has no effect on the transmit or receive operation if it is not enabled via EFR Bit-7.
DSR*	41	I	Data set ready. (active low) A low on this pin indicates the MODEM is ready to exchange data with UART. This pin does not have any effect on the transmit or receive operation.
CD*	42	I	Carrier detect. (active low) A low on this pin indicates the carrier has been detected by the modem.
RI*	43	I	Ring detect indicator. (active low) A low on this pin indicates the modem has received a ringing signal from telephone line.
VCC	44	I	Power supply input.

DESCRIPTION OF NEW FEATURES

The ST16C650 is designed to upgrade the existing 16C550 market. It provides additional features to reduce the software over-head, external glue logic, operating and stand-by current, and maintain the 16C550 software compatibility with existing software's.

After reset ST16C650 is down-ward compatible with ST16C450 and ST16C550 except it provides 32 bytes of data FIFO (when ST16C550 mode is enabled) instead of 16 bytes. All other additional features are available through special function register. The 40 pin Dip package offers the software/Hardware flow control, sleep mode, selectable transmit trigger levels, and two selectable baud rate generators. The 44 pin

PLCC package offers all the above features with selectable dual foot print (direct PC connect), two additional three state interrupt lines, and one selectable open source interrupt output to "Or" other ST16C650 interrupt outputs to reduce the number of interrupt lines.

When direct PC mode is selected (44 pin PLCC package only), the external glue logic which is used to decode the COM-1 (3F8-3FF), COM-2 (2F8-2FF), COM-3 (3E8-3EF), and COM-4 (2E8-2EF) and select the proper interrupt lines have been implemented within the ST16C650. The ST16C650 provides Three selectable pins to select the desired ports and interrupts for automatic configurations. In addition to these

ST16C650

addresses the ST16C650 decodes two additional addresses for LPT-1 (378-37F, printer port-1), and LPT-2 (278-27F, printer port-2) via OP2 and Baudout pins. These address decodes are used for IBM PC or compatible computers serial and parallel ports. During Direct connect mode all three interrupts functions are three state interrupts, to activate the interrupts MCR bit-3 should be set to "1".

FUNCTIONAL DESCRIPTIONS

The 32 bytes data FIFO's are enabled when user writes to the ST16C550/ST16C650 FIFO control register. With standard 16C550 parts, the user can only set receive trigger levels but not transmit trigger level. The ST16C650 provides independent trigger levels for both receiver and transmitter. To be compatible with ST16C550, 16 bytes transmit trigger level is selected after reset. Note that user can write to transmit trigger levels but activation will not take place till ST16C650 special mode is selected (EFR bit-4 is set to "1"). The ST16C650 is designed to work with high speed modems and shared network environments, that requires fast processing time. By increasing number of characters in the FIFO, networking units can handle more data within same time. Example: ST16C550 with 16 bytes of data, 115.2k and 8 bits wide word and one stop bit, will take 1.52 ms to transmit 16 bytes of data. But with 32 bytes of data buffer it will take 3.05 ms. This will give additional time for the CPU to process other applications and reduce the interrupt servicing time.

The contents of the Xon-1,2 and Xoff 1,2 are not reset to any given values and user can write any values desired for software flow controls. Different conditions can be set to detect Xon/Xoff characters or start/stop the transmissions. See the table for all possible conditions. When single Xon/Xoff characters are selected, ST16C650 compares the incoming data with these values and controls the transmission, these characters are not stacked in data buffer or FIFO. Special case is provided to detect the special character and stack it into the data buffer or FIFO. These conditions are selected via Enhanced Feature Register (EFR bit 0-3).

Hardware flow control can be selected when either or both bits of the EFR bit 6-7 are set to "1". When auto CTS is selected, the ST16C650 will stop the transmission as soon as a complete character is transmitted and CTS input level is high. Transmission is resumed after CTS input changes to low level.

RTS pin will be forced to high state regardless of it's original state when receive FIFO reaches to the programmed trigger level. RTS pin resumes it original state after content of the data buffer (FIFO) drops below the programmed trigger level. Both hardware and software flow controls can be enabled for automatic operation. During these conditions the ST16C650 will accept additional data to fill the unused transmit and receive FIFO locations.

Special interrupt modes have been added to monitor the hardware and software flow conditions. These are the IER bits 5-7.

The ST16C650 is designed to operate with low power consumption, special sleep mode has been added to stop the clock and reduce the power consumption when it is not used (Green PC). When EFR bit-4 and IER bit-4 are enabled (set to "1"), the ST16C650 enters into sleep mode and resumes it's normal operation when a data is received or state of the modem input pins changes or it is set to transmit data. The ST16C650 stays in this mode till it is disabled.

Special care should be considered for the following interrupt conditions and handling them. After reset if transmitter interrupt is enabled, ST16C650 will issue an interrupt to indicate that transmit holding register is empty, no other interrupts will be issued after enabling the interrupt. The LSR register has highest interrupt priority and CTS, RTS have lowest interrupt priority. The interrupt status register will show the highest interrupt priority condition, and after servicing the interrupt condition next priority interrupt level will be shown. There are two interrupt conditions that have same priority and it is important to know the conditions to service. Receive data ready and receive time out share the same priority with one additional bit (IER bit-3). Receiver issues interrupt after number of characters are reached the programmed trigger level, in this

case the ST16C650 FIFO holds equal or more characters than the trigger level. After reading block of data, user can check the LSR bit-0 for additional characters. If number of characters in the receive data register did not reach to programmed trigger level within certain time frame, ST16C650 will issue receive data ready interrupt with ISR bit-3 set to "1".

Note that, receive time out is functional only in ST16C550/650 mode. Receive time out will not occur if the receive FIFO is empty. The time out counter will be reset at the center of each stop bit received or each time receive holding register is read. The actual time out value is T (Time out length in bits) = $4 \times P$ (Programmed word length) + 12. To convert time out value to a character value, user has to divide this number to its complete word length + parity (if used) + number of stop bits and start bit.

Example -A: If user programs the word length = 7, and no parity and one stop bit, Time out will be:

$T = 4 \times 7$ (programmed word length) + 12 = 40 bits
 Character time = $40 / 9$ [(programmed word length = 7) + (stop bit = 1) + (start bit = 1)] = 4.4 characters.

Example -B: If user programs the word length = 7, with parity and one stop bit, the time out will be:

$T = 4 \times 7$ (programmed word length) + 12 = 40 bits
 Character time = $40 / 10$ [(programmed word length = 7) + (parity = 1) + (stop bit = 1) + (start bit = 1)] = 4 characters.

Due to number of active simultaneous interrupt limitations in PC and compatibles, ST16C650 offers share interrupt out by setting MCR bit-5 to "1". If this mode is selected, it is required to connect 200-500 ohm resistor between the INTA pin to Ground. Note that other interrupts (INTB, INTC) will be inactive during this mode.

Dual baud rate generator is provided to maintain the 16C550 compatibility and provide higher data rate when it is needed. Example 14.4k to 19.2k modems requires to have 57k to 115.2k data rate and 28.8k modem requires to have 230.4K. The 16C550 compatible parts can only offer 115.2k to maintain the software compatibility. The ST16C650 utilizes 7.32 MHz crystal/clock and provide 16C550 compatible data rate and higher. ST16C550 and ST16C650 baud

rate generator tables can be selected is setting and resetting the MCR bit-7.

The ST16C650 transmit trigger level, provides additional flexibility to the user for block mode operation. In ST16C550/650 mode LSR bits 5-6 gives indication that transmitter is empty or not, but there is no mechanism to identify FIFO full state or available empty locations in FIFO. User can select one of the two possible ways to operate the transmit and receive FIFO by utilizing the DMA mode (FCR bit-3). When FIFO's are enabled and DMA mode "0" is selected, the ST16C650 sets the interrupt bit and activates interrupt output pin for single transmit and receive operation like ST16C450 mode except it can receive and transmit 32 bytes of characters. When DMA mode "1" is activated, user takes the advantage of the block mode operation. In this mode, transmitter/receiver sets the interrupt flag and interrupt output pin, when characters in the FIFO are below the transmit trigger level or over receive trigger level. Note that since ST16C550 does not have transmit trigger levels, the default trigger level in the ST16C650 is set to 16 bytes (trigger level "0").



ST16C650

PROGRAMMING TABLE

A2	A1	A0	READ MODE	WRITE MODE
0	0	0	Receive Holding Register	Transmit Holding Register
0	0	1		Interrupt Enable Register
0	1	0	Interrupt Status Register	FIFO Control Register
0	1	1		Line Control Register
1	0	0		Modem Control Register
1	0	1	Line Status Register	
1	1	0	Modem Status Register	
1	1	1	Scratchpad Register	Scratchpad Register
0	0	0	LSB of Divisor Latch	LSB of Divisor Latch
0	0	1	MSB of Divisor Latch	MSB of Divisor Latch
0	1	0	Enhanced Feature Register	Enhanced Feature Register
1	0	0	Xon-1 Word	Xon-1 Word
1	0	1	Xon-2 Word	Xon-2 Word
1	1	0	Xoff-1 Word	Xoff-1 Word
1	1	1	Xoff-2 Word	Xoff-2 Word

These registers are accessible only when LCR bit-7 is set to "1". Enhanced Feature Register is accessible only when LCR is set to "FF"

ST16C650 ACCESSIBLE REGISTERS

A2 A1 A0	Register	BIT-7	BIT-6	BIT-5	BIT-4	BIT-3	BIT-2	BIT-1	BIT-0
0 0 0	RHR	bit-7	bit-6	bit-5	bit-4	bit-3	bit-2	bit-1	bit-0
0 0 0	THR	bit-7	bit-6	bit-5	bit-4	bit-3	bit-2	bit-1	bit-0
0 0 1	IER	0/ CTS interrupt	0/ RTS interrupt	0/ Xoff interrupt	0/ Sleep mode	modem status interrupt	receive line status interrupt	transmit holding register	receive holding register
0 1 0	FCR	RCVR trigger (MSB)	RCVR trigger (LSB)	0/TX trigger (MSB)	0/TX trigger (LSB)	DMA mode select	XMIT FIFO reset	RCVR FIFO reset	FIFO enable
0 1 0	ISR	0/ FIFO's enabled	0/ FIFO's enabled	0/ RTS, CTS	0/ Xoff	int priority bit-2	int priority bit-1	int priority bit-0	int status
0 1 1	LCR	divisor latch enable	set break	set parity	even parity	parity enable	stop bits	word length bit-1	word length bit-0
1 0 0	MCR	Clock select	0/ IRRT enable	INTA type select	loop back	OP2*/ IRQx enable	OP1*	RTS*	DTR*
1 0 1	LSR	0/ FIFO error	trans. empty	trans. holding empty	break interrupt	framing error	parity error	overrun error	receive data ready
1 1 0	MSR	CD	RI	DSR	CTS	delta CD*	delta RI*	delta DSR*	delta CTS*
1 1 1	SPR	bit-7	bit-6	bit-5	bit-4	bit-3	bit-2	bit-1	bit-0
0 0 0	DLL	bit-7	bit-6	bit-5	bit-4	bit-3	bit-2	bit-1	bit-0
0 0 1	DLM	bit-15	bit-14	bit-13	bit-12	bit-11	bit-10	bit-9	bit-8
0 1 0	EFR	Auto CTS	Auto RTS	Special Char. select	Enable IER Bits 4-7, ISR, FCR Bits 4-5, MCR Bits 6,7	Cont-3 Tx,Rx Control	Cont-2 Tx,Rx Control	Cont-1 Tx,Rx Control	Cont-0 Tx,Rx Control

These registers are accessible only when LCR bit-7 is set to "1". Enhanced Feature Register is accessible only when LCR is set to "FF"

ST16C650

REGISTER FUNCTIONAL DESCRIPTIONS

OPERATING MODE.

The ST16C650 provides pin selectable interface for existing 16C550 and new designs.

PC mode can be selected by tying the SEL pin to GND. When PC mode is selected the ST16C650 eliminates the external address decode logic (glue logic) for COM1-4 and jumper setting for IRQ3, IRQ4 or IRQn. The ST16C650 can be configured as follows:

S3 S2 S1	Address	ComPort	IRQ
0 0 0	3F8-3FF	COM-1	IRQB**
0 0 1	2F8-2FF	COM-2	IRQC**
0 1 0	3E8-3EF	COM-3	IRQB**
0 1 1	2E8-2EF	COM-4	IRQC**
1 0 0	3F8-3FF	COM-1	IRQA**
1 0 1	2F8-2FF	COM-2	IRQA**
1 1 0	3E8-3EF	COM-3	IRQA**
1 1 1	2E8-2EF	COM-4	IRQA**

** All interrupt outputs are inactive (three state mode) except the selected address.

TRANSMIT AND RECEIVE HOLDING REGISTER

The serial transmitter section consists of a Transmit Hold Register (THR) and Transmit Shift Register (TSR). The status of the transmit hold register is provided in the Line Status Register (LSR). Writing to this register (THR) will transfer the contents of data bus (D7-D0) to the Transmit holding register whenever the transmitter holding register or transmitter shift register is empty. The transmit holding register empty flag will be set to "1" when the transmitter is empty or data is transferred to the transmit shift register. Note that a write operation should be performed when the transmit holding register empty flag is set.

On the falling edge of the start bit, the receiver internal counter will start to count 7 1/2 clocks (16x clock) which is the center of the start bit. The start bit is valid if the RX is still low at the mid-bit sample of the start bit. Verifying the start bit prevents the receiver from assembling a false data character due to a low going

noise spike on the RX input. Receiver status codes will be posted in the Line Status Register.

FIFO INTERRUPT MODE OPERATION

When the receive FIFO (FCR BIT-0=1) and receive interrupts (IER BIT-0=1) are enabled, receiver interrupt will occur as follows:

A) The receive data available interrupts will be issued to the CPU when the FIFO has reached its programmed trigger level; it will be cleared as soon as the FIFO drops below its programmed trigger level.

B) The ISR receive data available indication also occurs when the FIFO trigger level is reached, and like the interrupt it is cleared when the FIFO drops below the trigger level.

C) The data ready bit (LSR BIT-0) is set as soon as a character is transferred from the shift register to the receiver FIFO. It is reset when the FIFO is empty.

FIFO POLLED MODE OPERATION

When FCR BIT-0=1; resetting IER BIT 3-0 to zero puts the ST16C650 in the FIFO polled mode of operation. Since the receiver and transmitter are controlled separately either one or both can be in the polled mode operation by utilizing the Line Status Register.

A) LSR BIT-0 will be set as long as there is one byte in the receive FIFO.

B) LSR BIT4-1 will specify which error(s) has occurred.

C) LSR BIT-5 will indicate when the transmit FIFO is empty.

D) LSR BIT-6 will indicate when both transmit FIFO and transmit shift register are empty.

E) LSR BIT-7 will indicate when there are any errors in the receive FIFO.

PROGRAMMABLE BAUD RATE GENERATOR

The ST16C650 contains a programmable Baud Rate Generator that is capable of taking any clock input from DC-24 MHz and dividing it by any divisor from 1 to $2^{16} - 1$. The output frequency of the Baud-out* is equal to 16X of transmission baud rate (Baud-out* = 16 x Baud Rate). Customize Baud Rates can be achieved by selecting proper divisor values for MSB and LSB of baud rate generator.

BAUD RATE GENERATOR PROGRAMMING TABLE (7.372 MHz CLOCK):

BAUD RATE MCR BIT-7=1	BAUD RATE MCR Bit-7=0	16 x CLOCK DIVISOR "Decimal"
50	200	2304
75	300	1536
150	600	768
300	1200	384
600	2400	192
1200	4800	96
2400	9600	48
4800	19.2K	24
7200	28.8K	16
9600	38.4k	12
19.2K	76.8k	6
38.4K	153.6k	3
57.6K	230.4k	2
115.2K	460.8k	1

HARDWARE FLOW CONTROL OPERATION.

When hardware flow control operation is enabled, the ST16C650 monitors the CTS* pin for transmit operation and receiver trigger level for RTS* operation. When CTS* changes state from low to high, the ST16C650 suspends the transmission operation as soon as complete character is transmitted. ISR bit-5 will be set (if enabled via IER bit 6-7). Transmission will resume as soon as CTS* pin goes low. RTS* pin will be forced to high state when receiver FIFO

reached to the programmed trigger level. RTS* will go low when Receive Holding Register is below next lower trigger level. The ST16C650 will accept additional data when transmission is suspended during hardware flow control till all locations are filled.

SOFTWARE FLOW CONTROL

When software flow control operation is enabled, the ST16C650 will compare the two sequential receive data with Xoff-1,2 programmed characters. When these characters matched correctly, the ST16C650 will halt the transmission after finishing the transmission of the complete character. The receive ready, Xoff (if enabled via IER bit-5) flags will be set and the interrupt output pin (if receive interrupt is enabled) will be activated. After the recognition of the Xoff characters the ST16C650 will compare next two incoming characters with Xon-1,2 characters. The ST16C650 will resume the operation and clear the flags (ISR bit-4) when Xon characters are received. The ST16C650 will send Xoff-1,2 characters as soon as received data passed the programmed trigger level. The ST16C650 will transmit programmed Xon-1,2 characters as soon as receive data reached to the next lower trigger level.

INTERRUPT ENABLE REGISTER (IER)

The Interrupt Enable Register (IER) masks the incoming interrupts from receiver ready, transmitter empty, line status and modem status registers to the INT output pin.

IER BIT-0:

0= disable the receiver ready interrupt.
1=enable the receiver ready interrupt.

IER BIT-1:

0= disable the transmitter empty interrupt.
1= enable the transmitter empty interrupt.

IER BIT-2:

0= disable the receiver line status interrupt.
1= enable the receiver line status interrupt.

IER BIT-3:

0= disable the modem status register interrupt.

ST16C650

1= enable the modem status register interrupt.

IER BIT -4:

0= disable sleep mode.

1= enable sleep mode. The ST16C650 enters into power down mode and external clock or oscillator circuit is disabled. Any change of state on the RX, RI*, CTS*, DSR*, and CD* pins start the ST16C650. The ST16C650 will not lose the programmed bits when sleep mode is activated or deactivated. The ST16C650 will not enter in sleep mode if any interrupt is pending.

IER BIT-5:

0= disable the received Xoff interrupt.

1= enable the received Xoff interrupt. The ST16C650 issues an interrupt when Xoff characters are received and correctly matched with Xoff 1,2 words.

IER BIT-6:

0= disable the RTS interrupt.

1= enable the RTS interrupt. The ST16C650 issues interrupt when RTS pin changes state from low to high.

IER BIT-7:

0= disable the CTS interrupt.

1= enable the CTS interrupt. The ST16C650 issues interrupt when CTS pin changes state from low to high.

INTERRUPT STATUS REGISTER (ISR)

The ST16C650 provides four level prioritized interrupt conditions to minimize software overhead during data character transfers. The Interrupt Status Register (ISR) provides the source of the interrupt in prioritized matter. During the read cycle the ST16C650 provides the highest interrupt level to be serviced by CPU. No other interrupts are acknowledged until the particular interrupt is serviced. The following are the prioritized interrupt levels:

Priority level

P	D5	D4	D3	D2	D1	D0	Source of the interrupt
1	0	0	0	1	1	0	LSR (Receiver Line Status Register)
2	0	0	0	1	0	0	RXRDY (Received Data Ready)
2	0	0	1	1	0	0	RXRDY (Receive Data time out)
3	0	0	0	0	1	0	TXRDY(Transmitter Holding Register Empty)
4	0	0	0	0	0	0	MSR (Modem Status Register)
5	0	1	0	0	0	0	RXRDY (Received Xoff signal)/ Special character
6	1	0	0	0	0	0	CTS, RTS change of state

ISR BIT-0:

0= an interrupt is pending and the ISR contents may be used as a pointer to the appropriate interrupt service routine.

1= no interrupt pending.

ISR BIT 1-3:

Logical combination of these bits, provides the highest priority interrupt pending.

ISR BIT 4-5:

These bits are enabled when FER bit-1 is set to "1". ISR bit-4 indicates that matching Xoff characters have been detected. ISR bit-5 indicates that CTS, RTS have been received or issued. Note that the ISR bit-4 will stay "1" till Xon characters are received.

ISR BIT 6-7:

These bits are not used and are set to zero in ST16C450 mode. BIT 6-7: are set to "1" in ST16C650 mode.

FIFO CONTROL REGISTER (FCR)

This register is used to enable the FIFOs, clear the FIFOs, set the receiver FIFO trigger level, and select the type of DMA signaling.

FCR BIT-0:

0= disable the transmit and receive FIFO.

1= enable the transmit and receive FIFO.

This bit should be enabled before setting the FIFO trigger levels.

FCR BIT-1:

0= No change.

1= Clears the contents of the receive FIFO and resets its counter logic to 0 (the receive shift register is not cleared or altered). This bit will return to zero after clearing the FIFOs.

FCR BIT-2:

0= No change.

1= Clears the contents of the transmit FIFO and resets its counter logic to 0 (the transmit shift register is not cleared or altered). This bit will return to zero after clearing the FIFOs.

FCR BIT-3:

0= No change.

1= Changes RXRDY and TXRDY pins from mode "0" to mode "1".

Transmit operation in mode "0":

When ST16C650 is in ST16C450 mode (FCR bit-0=0) or in the FIFO mode (FCR bit-0=1, FCR bit-3=0) when there are no characters in the transmit FIFO or transmit holding register, the TXRDY* pin will go low. Once active the TXRDY* pin will go high (inactive) after the first character is loaded into the transmit holding register.

Receive operation in mode "0":

When ST16C650 is in ST16C450 mode (FCR bit-0=0) or in the FIFO mode (FCR bit-0=1, FCR bit-3=0) and there is at least 1 character in the receive FIFO, the RXRDY* pin will go low. Once active the RXRDY* pin will go high (inactive) when there are no more characters in the receiver.

Transmit operation in mode "1":

When ST16C650 is in FIFO mode (FCR bit-0=1, FCR bit-3=1) the TXRDY* pin will become high (inactive) when the transmit FIFO is completely full. It will be low if one or more FIFO locations are empty.

Receive operation in mode "1":

When ST16C650 is in FIFO mode (FCR bit-0=1, FCR bit-3=1) and the trigger level or the time-out has been reached, the RXRDY* pin will go low. Once it is activated it will go high (inactive) when there are no more characters in the FIFO.

FCR BIT 4-5:

These bits are used to set the trigger level for the transmit FIFO interrupt. The ST16C650 will issue a transmit empty interrupt when number of characters in FIFO drops below the selected trigger level.

ST16C650

ST16C650

BIT-5	BIT-4	FIFO trigger level
0	0	16
0	1	8
1	0	24
1	1	30

FCR BIT 6-7:

These bits are used to set the trigger level for the receiver FIFO interrupt.

BIT-7	BIT-6	FIFO trigger level
0	0	8
0	1	16
1	0	24
1	1	28

LINE CONTROL REGISTER (LCR)

The Line Control Register is used to specify the asynchronous data communication format. The number of the word length, stop bits, and parity can be selected by writing appropriate bits in this register.

LCR BIT1-0:

These two bits specify the word length to be transmitted or received.

BIT-1	BIT-0	Word length
0	0	5
0	1	6
1	0	7
1	1	8

LCR BIT-2:

The number of stop bits can be specified by this bit.

BIT-2	Word length	Stop bit(s)
0	5,6,7,8	1
1	5	1-1/2
1	6,7,8	2

LCR BIT-3:

Parity or no parity can be selected via this bit.

0= no parity

1=a parity bit is generated during the transmission, receiver also checks for received parity.

LCR BIT-4:

If the parity bit is enabled, LCR BIT-4 selects the even or odd parity format.

0= ODD parity is generated by forcing an odd number of 1's in the transmitted data, receiver also checks for same format.

1= EVEN parity bit is generated by forcing an even number of 1's in the transmitted data, receiver also checks for same format.

LCR BIT-5:

If the parity bit is enabled, LCR BIT-5 selects the forced parity format.

LCR BIT-5=1 and LCR BIT-4=0, parity bit is forced to "1" in the transmitted and received data.

LCR BIT-5=1 and LCR BIT-4=1, parity bit is forced to "0" in the transmitted and received data.

LCR BIT-6:

Break control bit. It causes a break condition to be transmitted (the TX is forced to low state).

0= normal operating condition.

1= forces the transmitter output (TX) to go low to alert the communication terminal.

LCR BIT-7:

The internal baud rate counter latch and Enhance Feature mode enable (DLAB).

0= normal operation.

1= Divisor latch and Enhanced Feature register enable.

MODEM CONTROL REGISTER (MCR)

This register controls the interface with the MODEM or a peripheral device (RS232).

MCR BIT-0:

0= force DTR* output to high.
1= force DTR* output to low.

MCR BIT-1:

0= force RTS* output to high.
1= force RTS* output to low.
RTS* is used as hardware flow control signal when enabled via EFR bit-6. RTS* goes high when FIFO is reached to the selected trigger level and goes low as soon as content of the receive holding register is below the trigger level. Content of this register changes with state of the hardware flow control. Functions normally when hardware flow control is disabled.

MCR BIT-2:

0= set OP1* output to high.
1= set OP1* output to low.

MCR BIT-3:

0= set OP2* output to high (STD mode). Forces INTx outputs to three state mode during PC mode selection.
1= set OP2* output to low (STD mode). Sets the INTx outputs to active mode during PC mode selection

MCR BIT-4:

0= normal operating mode.
1= enable local loop-back mode (diagnostics). The transmitter output (TX) is set high (Mark condition), the receiver input (RX), CTS*, DSR*, CD*, and RI* are disabled. Internally the transmitter output is connected to the receiver input and DTR*, RTS*, OP1* and OP2* are connected to modem control inputs. In this mode, the receiver and transmitter interrupts are fully operational. The Modem Control Interrupts are also operational, but the interrupt sources are now the lower four bits of the Modem Control Register instead of the four Modem Control inputs. The interrupts are still controlled by the IER.

MCR BIT-5:

0= Active or three state interrupt output.
1= Open source interrupt output. Required external

resistor from this pin to ground. This mode is provided for share interrupts.

MCR BIT-6:

0= Standard UART receive and transmit input / output.
1= Infrared receive and transmit input / output.

MCR BIT-7:

0= Normal or divide by one clock input. Standard ST16C550 baud rates can be selected when this bit is set to "0" and 1.8432 MHz crystal is used.
1= Divide by four clock input. Standard ST16C550 baud rates can be selected when this bit is set to "1" and 7.372 MHz crystal is used.

LINE STATUS REGISTER (LSR)

This register provides the status of data transfer to CPU.

LSR BIT-0:

0= no data in receive holding register or FIFO.
1= data has been received and saved in the receive holding register or FIFO.

LSR BIT-1:

0= no overrun error (normal).
1= overrun error, next character arrived before receive holding register was emptied or if FIFOs are enabled, an overrun error will occur only after the FIFO is full and the next character has been completely received in the shift register. Note that character in the shift register is overwritten, but it is not transferred to the FIFO.

LSR BIT-2:

0= no parity error (normal).
1= parity error, received data does not have correct parity information. In the FIFO mode this error is associated with the character at the top of the FIFO.

LSR BIT-3:

0= no framing error (normal).
1= framing error received, received data did not have a valid stop bit. In the FIFO mode this error is associated with the character at the top of the FIFO.

ST16C650

LSR BIT-4:

0= no break condition (normal).

1= receiver received a break signal (RX was low for one character time frame). In FIFO mode, only one zero character is loaded into the FIFO.

LSR BIT-5:

It indicates that the ST16C650 is ready to accept a new character for transmission. In addition, it causes the ST16C650 to issue an interrupt to the CPU when the transmit holding register empty interrupt enable is set.

0= transmit holding register is not empty.

1= transmit holding register (or FIFO) is empty. CPU can load the next characters. When this bit is set, CPU can load upto 32 bytes of data to the ST16C650.

LSR BIT-6:

0= transmitter holding and shift registers are full.

1= transmitter holding and shift registers are empty. In FIFO mode this bit is set to one whenever the transmitter FIFO and transmit shift register are empty.

LSR BIT-7:

0= normal.

1= at least one parity error, framing error or break indication in the FIFO. This bit is cleared when LSR is read.

MODEM STATUS REGISTER (MSR)

This register provides the current state of the control lines from the modem or peripheral to the CPU. Four bits of this register are used to indicate the changed information. These bits are set to "1" whenever a control input from the MODEM changes state. They are set to "0" whenever the CPU reads this register.

MSR BIT-0:

Indicates that the CTS* input to the ST16C650 has changed state since the last time it was read.

MSR BIT-1:

Indicates that the DSR* input to the ST16C650 has changed state since the last time it was read.

MSR BIT-2:

Indicates that the RI* input to the ST16C650 has changed from a low to a high state.

MSR BIT-3:

Indicates that the CD* input to the ST16C650 has changed state since the last time it was read.

MSR BIT-4:

This bit is equivalent to RTS in the MCR during local loop-back mode. It is the compliment of the CTS* input.

CTS* functions as hardware flow control signal input if it is enabled via EFR bit-7. Transmit holding register is gated with this input to start/stop the transmission. A high at this pin will stop the transmission as soon as complete character is transmitted.

MSR BIT-5:

This bit is equivalent to DTR in the MCR during local loop-back mode. It is the compliment of the DSR* input.

MSR BIT-6:

This bit is equivalent to OP1 in the MCR during local loop-back mode. It is the compliment of the RI* input.

MSR BIT-7:

This bit is equivalent to OP2 in the MCR during local loop-back mode. It is the compliment to the CD* input.

Note: Whenever MSR BIT3-0: is set to logic "1", a MODEM Status Interrupt is generated.

SCRATCHPAD REGISTER (SR)

ST16C650 provides a temporary data register to store 8 bits of information for variable use.

ENHANCED FEATURE REGISTER (EFR)

Enhanced Features can be Enable/Disabled via this register.

EFR BIT 0-3:

Combinations of software flow control can be selected by programming this bits.



Cont-3	Cont-2	Cont-1	Cont-0	Tx, Rx software flow controls
0	0	X	X	No transmit flow control
1	0	X	X	Transmit Xon1, Xoff1
0	1	X	X	Transmit Xon2, Xoff2
1	1	X	X	Transmit Xon1 and Xon2 : Xoff1, Xoff2
X	X	0	0	No receive flow control
X	X	1	0	Receiver compares Xon1, Xoff1
X	X	0	1	Receiver compares Xon2, Xoff2
1	0	1	1	Transmit Xon1, Xoff1. Receiver compares Xon1 or Xon2, Xoff1 or Xoff2
0	1	1	1	Transmit Xon2, Xoff2 Receiver compares Xon1 or Xon2, Xoff1 or Xoff2
1	1	1	1	Transmit Xon1 and Xon2 : Xoff1 and Xoff2 Receiver compares Xon1 and Xon2 : Xoff1 and Xoff2
0	0	1	1	No transmit flow control Receiver compares Xon1 and Xon2 : Xoff1 and Xoff2

EFR BIT-4:

Enhanced interrupt control bit.

0= disables the IER bits 4-7 and ISR bits 4-5. Standard ST16C550 mode.

1= enables the enhanced interrupt functions.

EFR BIT-5:

0= Normal.

1= Special character detect. ST16C650 compares the incoming receive data with Xoff-2 data. Up on correct match, the received data will be transferred to FIFO

and ISR Bit-4 will be set to indicate detection of special character.

EFR BIT-6:

RTS* flow control.

0 = Normal. RTS* flow control is disabled. Standard ST16C550 mode.

1 = RTS pin goes high when receive FIFO's are reach to the programmed trigger level.

ST16C650

EFR Bit-7:

CTS* flow control.

0 = Normal. CTS* flow control mode is disabled. Standard ST16C550 mode.

1 = Transmission is resumed when low input signal is detected on the CTS* pin.

ST16C650 EXTERNAL RESET CONDITION

REGISTERS	RESET STATE
IER	IER BITS 0-7=0
ISR	ISR BIT-0=1, ISR BITS 1-7=0
LCR	LCR BITS 0-7=0
MCR	MCR BITS 0-7=0
LSR	LSR BITS 0-4=0, LSR BITS 5-6=1 LSR, BIT 7=0
MSR	MSR BITS 0-3=0, MSR BITS 4-7= input signals
FCR	FCR BITS 0-7=0
FER	FER BITS 0-7=0

SIGNALS	RESET STATE
TX	High
OP1*	High
OP2*	High
RTS*	High
DTR*	High
RXRDY*	High (STD mode), / Three state (PC mode)
TXRDY*	High (STD mode) / Three state (PC mode)
IRQn/NT	Low (STD mode) / Three state (PC mode)

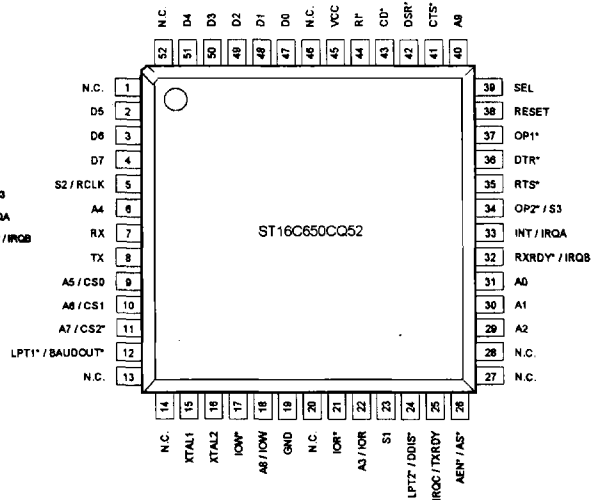
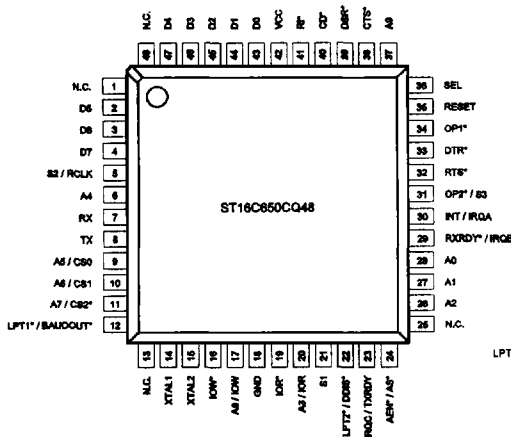

AC ELECTRICAL CHARACTERISTICS

T_A=0° - 70° C, V_{CC}=5.0 V ± 10% unless otherwise specified.

Symbol	Parameter	Limits			Units	Conditions	
		Min	Typ	Max			
T ₁	Clock high pulse duration	50			ns	External clock	
T ₂	Clock low pulse duration	50			ns		
T ₃	Clock rise/fall time			10	ns	100 pF load	
T ₄	Baud out rise/fall time			100	ns		
T ₅	Address strobe width	30			ns	100 pF load	
T ₆	Address setup time	30			ns		
T ₇	Address hold time	5			ns		
T ₈	Chip select setup time	5			ns		
T ₉	Chip select hold time	0			ns		
T ₁₁	IOR* to DDIS* delay			25	ns		
T ₁₂	Data setup time	15			ns		Note: 1
T ₁₃	Data hold time	15			ns		Note: 1
T ₁₄	IOW* delay from chip select	10			ns		Note: 1
T ₁₅	IOW* strobe width	50			ns		Note: 1
T ₁₆	Chip select hold time from IOW*	0			ns		
T ₁₇	Write cycle delay	55			ns	Note: 1	
T _w	Write cycle=T ₁₅ +T ₁₇	105			ns		
T ₁₉	Data hold time	15		25	ns	Note: 1	
T ₂₁	IOR* delay from chip select	10			ns		
T ₂₃	IOR* strobe width	65			ns	Note: 1	
T ₂₄	Chip select hold time from IOR*	0			ns		
T ₂₅	Read cycle delay	55			ns	Note: 1	
T _r	Read cycle=T ₂₃ +T ₂₅	115			ns		
T ₂₆	Delay from IOR* to data			35	ns	100 pF load	
T ₂₈	Delay from IOW* to output			50	ns	100 pF load	
T ₂₈	Delay to set interrupt from MODEM			70	ns	100 pF load	
T ₃₀	Delay to reset interrupt from IOR* input			70	ns	100 pF load	
T ₃₁	Delay from stop to set interrupt			1 _{RCK}		100 pF load	
T ₃₂	Delay from IOR* to reset interrupt			200	ns	100 pF load	
T ₃₃	Delay from initial INT reset to transmit start	8		24	*		
T ₃₄	Delay from stop to interrupt			100	ns		
T ₃₅	Delay from IOW* to reset interrupt			175	ns		
T ₄₄	Delay from stop to set RxRdy			1 _{RCLK}			
T ₄₅	Delay from IOR* to reset RxRdy			1	μs		
T ₄₆	Delay from IOW* to set TxRdy			195	ns		
T ₄₇	Delay from start to reset TxRdy			8	*		

Note 1: Applicable only when AS* is tied low
 * = Baud-out* cycle



ST16C650

ABSOLUTE MAXIMUM RATINGS

Supply range	7 Volts
Voltage at any pin	GND-0.3 V to VCC+0.3 V
Operating temperature	0° C to +70° C
Storage temperature	-40° C to +150° C
Package dissipation	500 mW

DC ELECTRICAL CHARACTERISTICS

$T_A = 0^\circ - 70^\circ \text{ C}$, $V_{CC} = 5.0 \text{ V} \pm 10\%$ unless otherwise specified.

Symbol	Parameter	Limits			Units	Conditions
		Min	Typ	Max		
V_{ILCK}	Clock input low level	-0.5		0.6	V	
V_{IHCK}	Clock input high level	3.0		VCC	V	
V_{IL}	Input low level	-0.5		0.8	V	
V_{IH}	Input high level	2.2		VCC	V	
V_{OL}	Output low level on all outputs			0.4	V	
V_{OH}	Output high level	2.4			V	$I_{OL} = 8 \text{ mA}$ $I_{OH} = -8 \text{ mA}$
I_{CC}	Avg power supply current		1.2		mA	
V_{OP}	Operating voltage	2.7		5.50	V	
I_{SLP}	Avg sleep mode current		750		μA	
I_{IL}	Input leakage			± 10	μA	
I_{CL}	Clock leakage			± 10	μA	

CLOCK TIMING

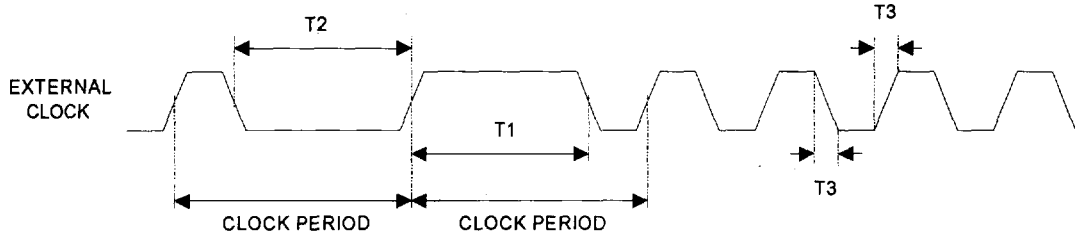

BAUDOUT* TIMING

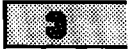
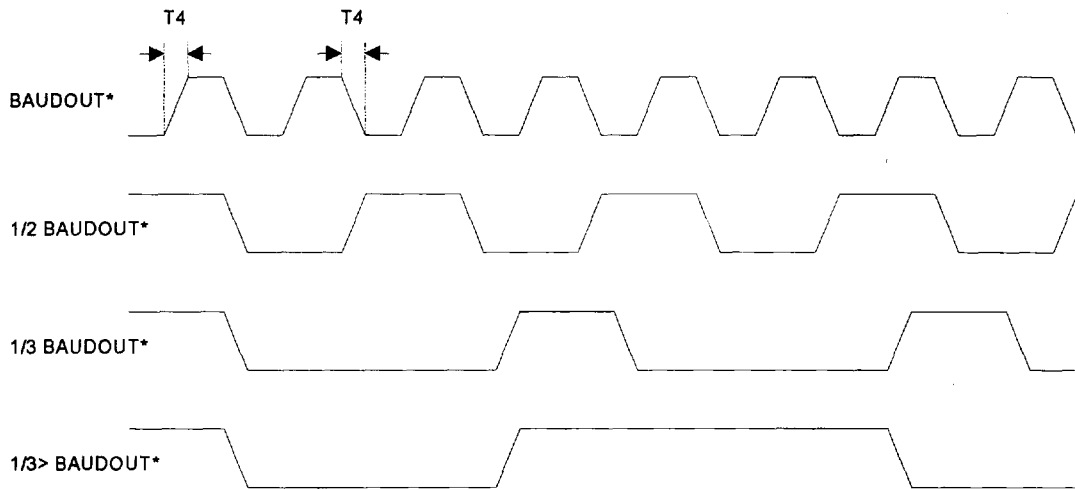

ST16C650

ST16C650

GENERAL READ TIMING

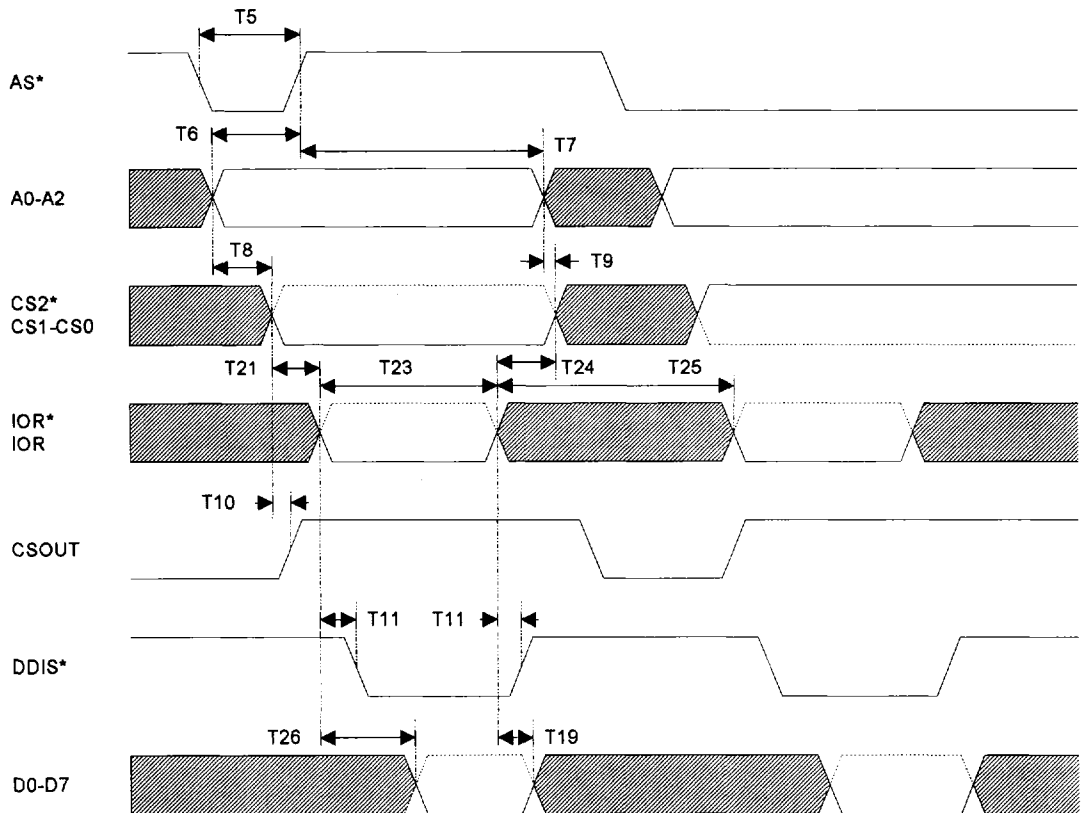

GENERAL WRITE TIMING

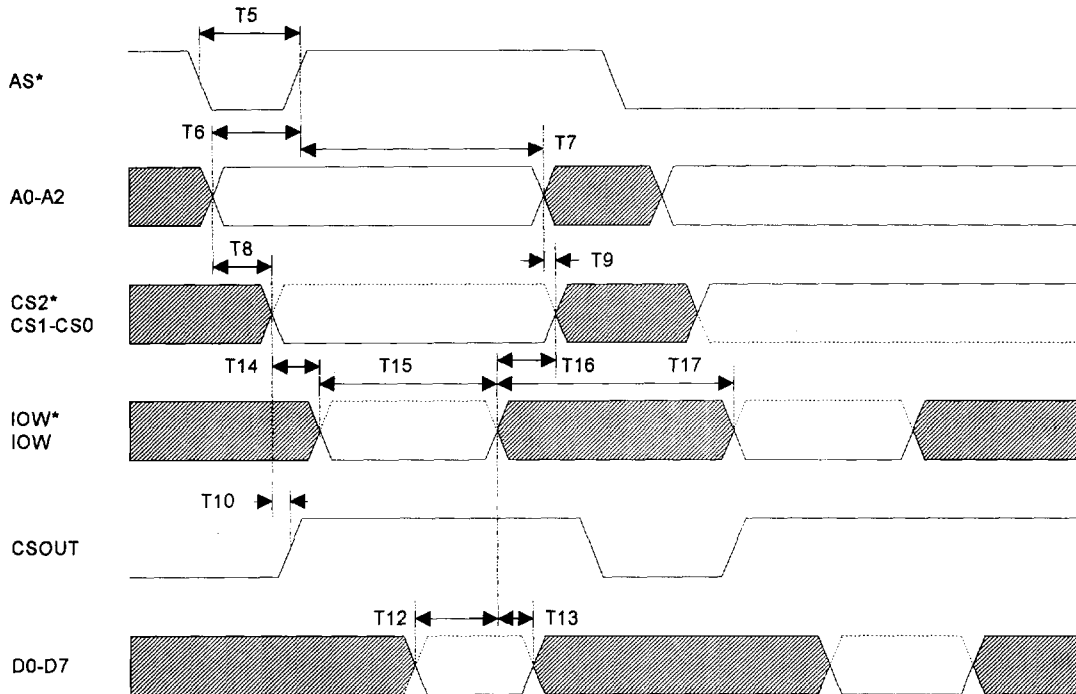

ST16C650

MODEM TIMING

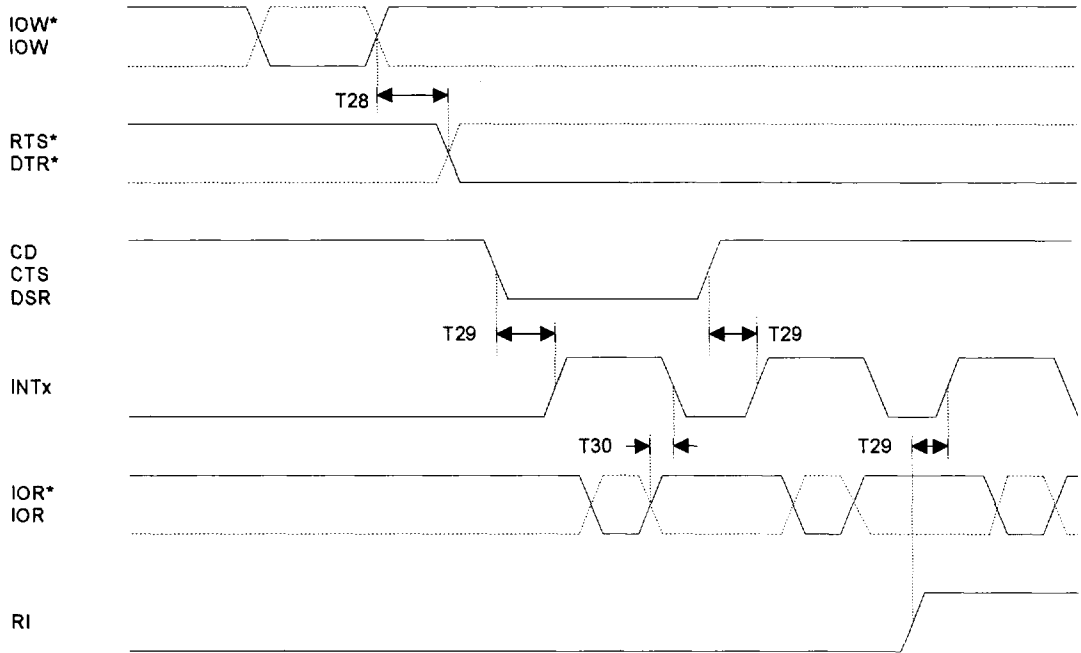

RECEIVE TIMING

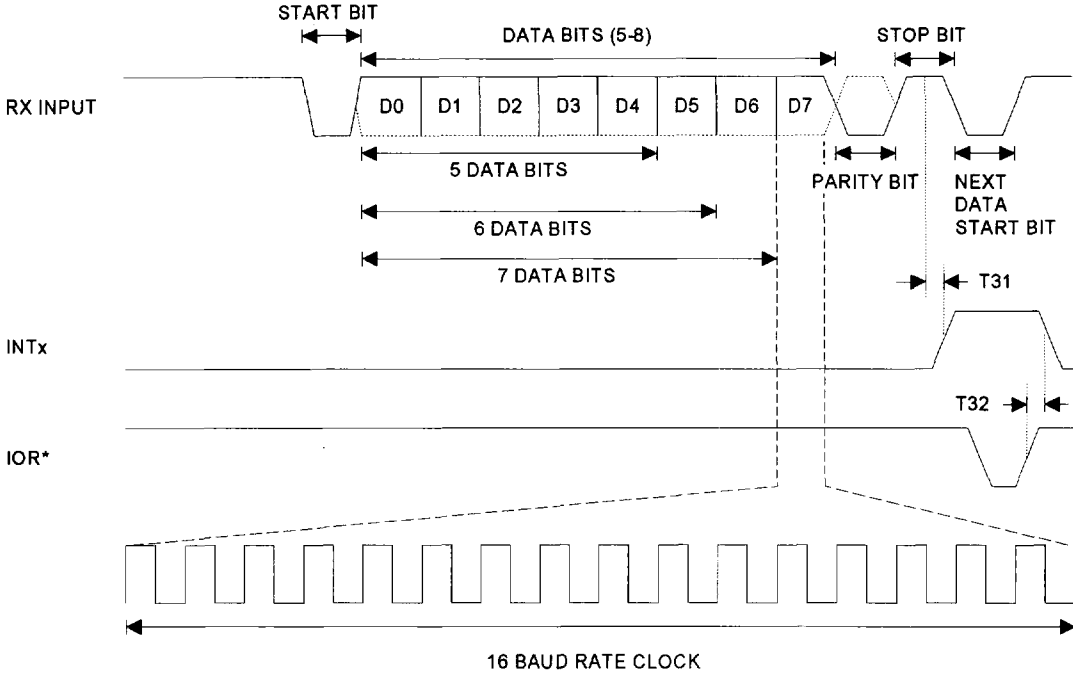

ST16C650

ST16C650

RXRDY TIMING FOR MODE "0"

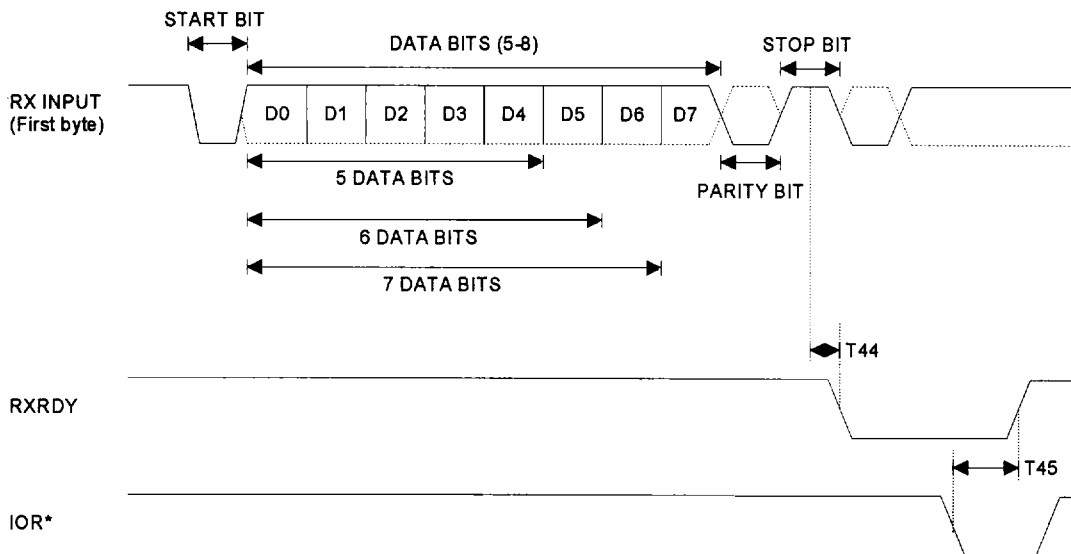

RXRDY TIMING FOR MODE "1"

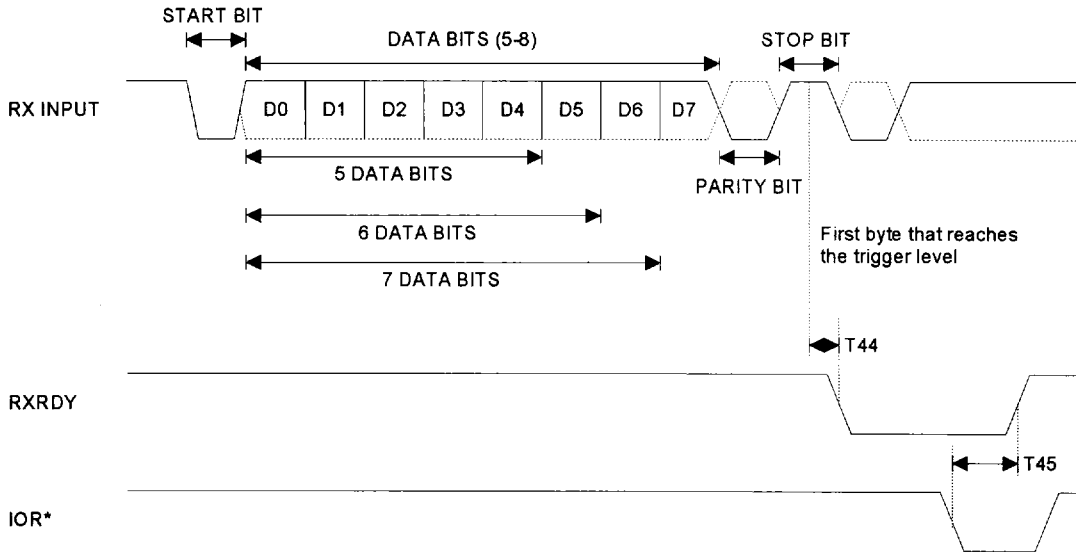

ST16C650

ST16C650

TRANSMIT TIMING

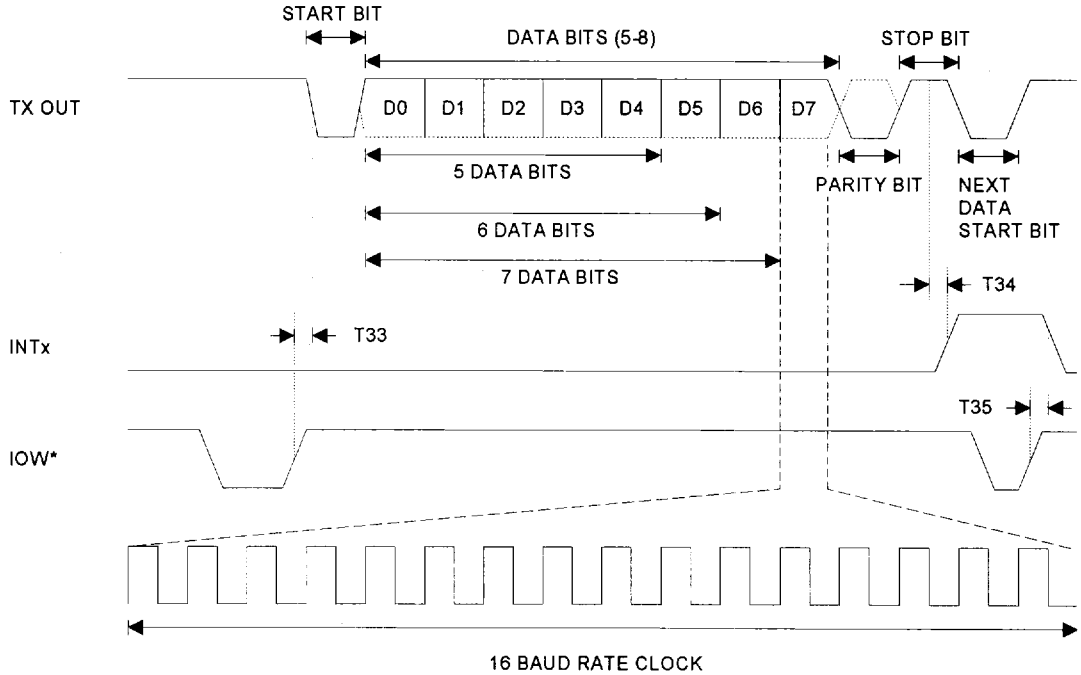

TXRDY TIMING FOR MODE "0"

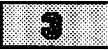
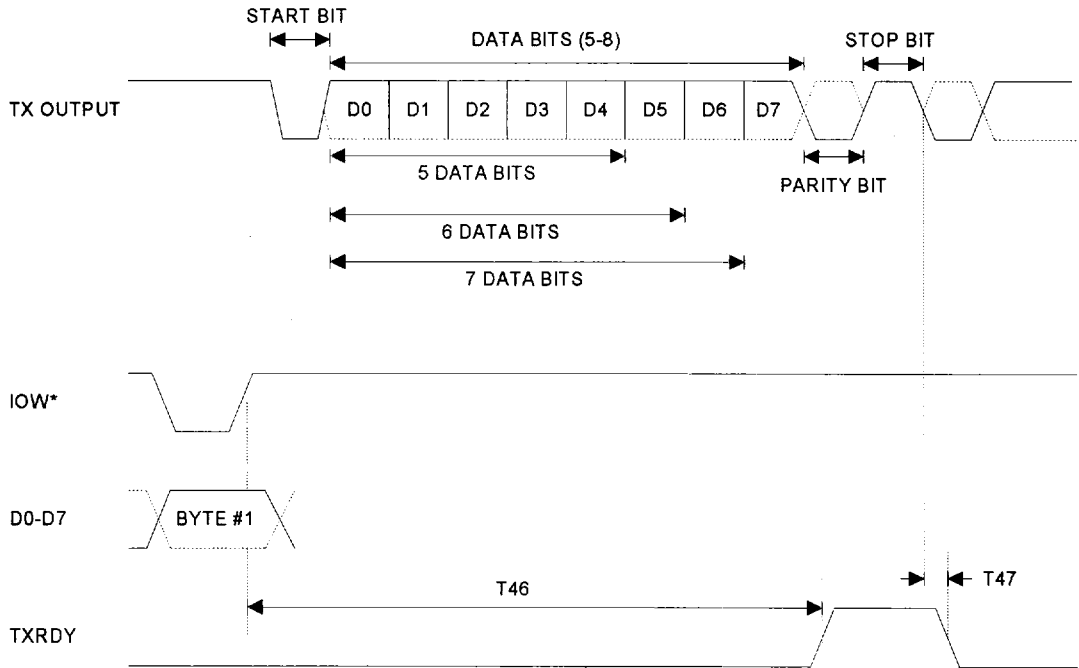

ST16C650

TXRDY TIMING FOR MODE "1"

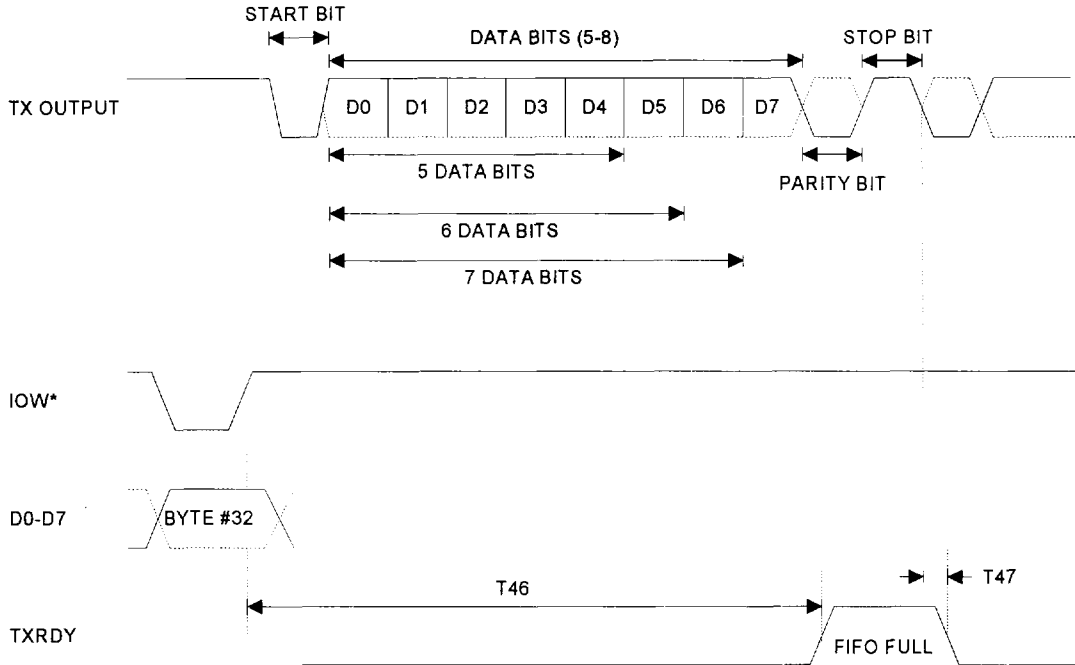

IR TRANSMIT AND RECEIVE INPUT/OUTPUT TIMING

