

# THIN FILM INDUCTORS

## KL73 薄膜チップインダクタ Thin Film Chip Inductors

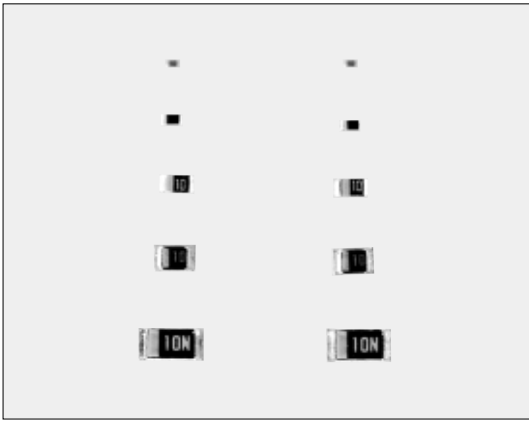

外装色：緑 Coating color : Green (1H only)  
：紺 : Dark blue

### 構造図 Construction

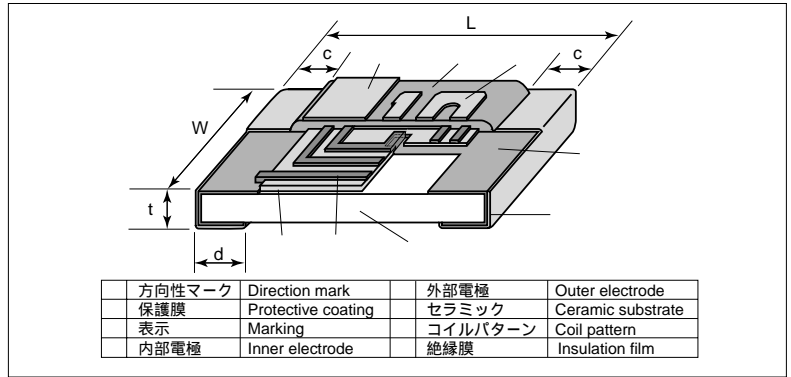

### ■特長 Features

- 独自の薄膜多層化技術により低抵抗、高Qを実現。
- ±2%の狭偏差により回路の無調整化が可能。
- 自己共振周波数が高く、高周波特性が優れている。
- 薄型小形形状で高密度実装に対応（0603サイズから3216サイズまで各タイプをラインアップ）。
- 方向性表示あり。（全サイズ）
- 1608サイズ以上では、L値表示があります。
- リフロー、フローはんだ付けに対応します。
- 端子鉛フリー品は、RoHS対応品です。
- KOA original thin-film multi-layer technology realizes low DC resistance and high Q.
- No circuit adjustment is possible due to narrow tolerance ±2%.
- High self resonant frequency and excellent high frequency characteristics.
- Applicable to high density mounting with thin and miniature type (each type of 0603~3216 sizes is lined up).
- Direction marking. (All size)
- Inductance value marking. (1J, 2A, 2B)
- Suitable for both reflow and flow solderings.
- Products with lead free termination meet RoHS requirements.

### ■用途 Applications

- セルラ、ページャ等移動体通信機器の端末及び基地局の高周波回路
- High frequency circuits in terminal and base station of mobile wireless equipment such as Cellulars and Pagers.

### ■性能 Performance

試験項目 Test Items	規格値 Performance Requirements		試験方法 Test Methods
	Maximum	L/L	
はんだ耐熱性 Resistance to soldering heat	L/L: ±2%, Q/Q: ±20% 外觀・構造に著しい異常がないこと。 Without distinct damage in appearance and construction.	L/L: ±0.5% Q/Q: ±1.5%	260 ±5, 10s ±1s
温度急変 Rapid change of temperature	L/L: ±2%, Q/Q: ±20% 外觀・構造に著しい異常がないこと。 Without distinct damage in appearance and construction.	L/L: ±0.5% Q/Q: ±1.6%	-40 (30min.) + 125 (30min.) 100 cycles
低温放置 Low temperature exposure	L/L: ±2%, Q/Q: ±20% 外觀・構造に著しい異常がないこと。 Without distinct damage in appearance and construction.	L/L: ±0.7% Q/Q: ±1.2%	-40 ±3, 1000h
高温放置 High temperature exposure	L/L: ±2%, Q/Q: ±20% 外觀・構造に著しい異常がないこと。 Without distinct damage in appearance and construction.	L/L: ±0.4% Q/Q: ±1.3%	125 ±2, 1000h
耐湿性 Moisture endurance	L/L: ±2%, Q/Q: ±20% 外觀・構造に著しい異常がないこと。 Without distinct damage in appearance and construction. 絶縁抵抗: 50M 以上 Insulation Resistance: 50M or more	L/L: ±0.4% Q/Q: ±1.4%	40 ±2, 90%~95%RH, 1000h
耐溶剤性 Resistance to solvent	L/L: ±2%, Q/Q: ±20% 表示・外觀・構造に著しい異常がないこと。 Without distinct damage in appearance, construction and marking.	L/L: ±0.6% Q/Q: ±1.2%	チップコイルをJIS K8839(1995) 2-プロパノールの試薬(温度20~25)の中に30s ±5s秒間、浸せきする。 Immerse the inductors for 30s ±5s in the reagent (20~25) of JIS K8839(1995)

### ■外形寸法 Dimensions

形名 Type (Inch Size Code)	寸法 Dimensions (mm)					Weight (g) (1000pcs)
	L	W	c	d	t	
1H (0201)	0.6 ± 0.03	0.3 ± 0.03	0.08 ± 0.05	0.15 ± 0.05	0.23 ± 0.03	0.16
1E (0402)	1.0 ± 0.1	0.5 ± 0.05	0.15 ± 0.1	0.25 ± 0.1	0.35 ± 0.05	0.68
1J (0603)	1.6 ± 0.2	0.8 ± 0.1	0.3 ± 0.1	0.3 ± 0.1	0.5 ± 0.1	2.14
2A (0805)	2.0 ± 0.2	1.25 ± 0.2	0.4 ± 0.2	0.3 ± 0.2	0.5 ± 0.1	4.54
2B (1206)	3.2 ± 0.2	1.6 ± 0.2	0.5 ± 0.2	0.4 <sup>+0.2</sup> / <sub>-0.1</sub>	0.6 ± 0.1	9.14

### ■品名構成 Type Designation

#### 例 Example

Old Type	KL73	1E	TP	10N	G	
New Type	KL73	1E	T	TP	10N	G
品名 Product Code	形状 Style	端子表面材質 Terminal Surface Material	二次加工 Taping	公称インダクタンス Nominal Inductance	許容差 Tolerance	
	1H: 0.6 × 0.3mm 1E: 1.0 × 0.5mm 1J: 1.6 × 0.8mm 2A: 2.0 × 1.25mm 2B: 3.2 × 1.6mm	T: Sn L: Sn/Pb (1Hを除く) (Except 1H)	TB: 2mm pitch press paper TP: 2mm pitch paper TE: 4mm pitch plastic embossed BK: Bulk		B: ±0.1nH C: ±0.2nH G: ±2% J: ±5%	

端子表面材質は鉛フリーめっき品が標準となります。  
テーピングの詳細については巻末のAPPENDIX Cを参照して下さい。  
For further information on taping, please refer to APPENDIX C on the back pages.

## ■定格 Ratings

使用温度範囲 Operating temperature range - 40 ~ + 125

テーピング記号と包装数/リール Taping code and Q'ty/Reel 1H : TB (10,000pcs), 1E : TP (10,000pcs)

形名 Type	表示 Marking	公称インダクタンス Nominal Inductance (nH)	インダクタンス許容差 Inductance Tolerance	Q値 Quality Factor Min.	自己共振周波数 Self Resonant Frequency (MHz) Min.	直流抵抗 DC Resistance (Ω) Max.	許容直流電流 Allowable DC Current (mA) Max.	測定周波数 Measuring Frequency (MHz)
KL73 1H TTB 0N6□	-	0.6	B : ±0.1nH/C : ±0.2nH	5	9,000	0.20	350	500
KL73 1H TTB 0N7B	-	0.7	B : ±0.1nH					
KL73 1H TTB 0N8□	-	0.8	B : ±0.1nH/C : ±0.2nH					
KL73 1H TTB 0N9B	-	0.9	B : ±0.1nH					
KL73 1H TTB 1N0□	-	1.0	B : ±0.1nH/C : ±0.2nH					
KL73 1H TTB 1N1B	-	1.1	B : ±0.1nH					
KL73 1H TTB 1N2□	-	1.2	B : ±0.1nH/C : ±0.2nH					
KL73 1H TTB 1N3B	-	1.3	B : ±0.1nH					
KL73 1H TTB 1N5□	-	1.5	B : ±0.1nH/C : ±0.2nH					
KL73 1H TTB 1N6B	-	1.6	B : ±0.1nH					
KL73 1H TTB 1N8□	-	1.8	B : ±0.1nH/C : ±0.2nH					
KL73 1H TTB 2N0B	-	2.0	B : ±0.1nH					
KL73 1H TTB 2N2□	-	2.2	B : ±0.1nH/C : ±0.2nH					
KL73 1H TTB 2N4B	-	2.4	B : ±0.1nH					
KL73 1H TTB 2N7□	-	2.7	B : ±0.1nH/C : ±0.2nH					
KL73 1H TTB 3N0B	-	3.0	B : ±0.1nH					
KL73 1H TTB 3N3□	-	3.3	B : ±0.1nH/C : ±0.2nH					
KL73 1H TTB 3N6B	-	3.6	B : ±0.1nH					
KL73 1H TTB 3N9□	-	3.9	B : ±0.1nH/C : ±0.2nH					
KL73 1H TTB 4N3B	-	4.3	B : ±0.1nH					
KL73 1H TTB 4N7□	-	4.7	B : ±0.1nH/C : ±0.2nH					
KL73 1H TTB 5N1G	-	5.1	G : ±2%					
KL73 1H TTB 5N6□	-	5.6	G : ±2%/J : ±5%					
KL73 1H TTB 6N2G	-	6.2	G : ±2%					
KL73 1H TTB 6N8□	-	6.8	G : ±2%/J : ±5%					
KL73 1H TTB 7N5G	-	7.5	G : ±2%					
KL73 1H TTB 8N2□	-	8.2	G : ±2%/J : ±5%					
KL73 1H TTB 9N1G	-	9.1	G : ±2%					
KL73 1H TTB 10N□	-	10	G : ±2% J : ±5%					
KL73 1H TTB 11N□	-	11						
KL73 1H TTB 12N□	-	12						
KL73 1H TTB 13N□	-	13						
KL73 1H TTB 15N□	-	15						
KL73 1H TTB 16N□	-	16						
KL73 1H TTB 18N□	-	18						
KL73 1H TTB 20N□	-	20						
KL73 1H TTB 22N□	-	22						
KL73 1H TTB 24N□	-	24						
KL73 1H TTB 27N□	-	27						
KL73 1H TTB 33N□	-	33						
KL73 1H TTB 39N□	-	39						
KL73 1E □N56B	-	0.56	B : ±0.1nH	7	14,000	0.10	700	500
KL73 1E □N68B	-	0.68						
KL73 1E □N82B	-	0.82						
KL73 1E □1N0□	-	1.0	B : ±0.1nH C : ±0.2nH	10	12,000	0.15	650	
KL73 1E □1N2□	-	1.2						
KL73 1E □1N5□	-	1.5						
KL73 1E □1N8□	-	1.8						
KL73 1E □2N2□	-	2.2						
KL73 1E □2N7□	-	2.7						
KL73 1E □3N3□	-	3.3						
KL73 1E □3N9□	-	3.9						
KL73 1E □4N7□	-	4.7						
KL73 1E □5N6□	-	5.6						
KL73 1E □6N8□	-	6.8						
KL73 1E □8N2□	-	8.2						
KL73 1E □10N□	-	10						
KL73 1E □12N□	-	12						
KL73 1E □15N□	-	15						
KL73 1E □18N□	-	18						
KL73 1E □22N□	-	22						
KL73 1E □27N□	-	27						
KL73 1E □33N□	-	33						
KL73 1E □39N□	-	39						
KL73 1E □10N□	-	10	G : ±2% J : ±5%	7	1,500	5.00	150	
KL73 1E □12N□	-	12						
KL73 1E □15N□	-	15						
KL73 1E □18N□	-	18	G : ±2% J : ±5%	7	1,500	5.00	150	
KL73 1E □22N□	-	22						
KL73 1E □27N□	-	27						
KL73 1E □33N□	-	33	G : ±2% J : ±5%	7	1,500	5.00	150	
KL73 1E □39N□	-	39						
KL73 1E □33N□	-	33						

インダクタ  
Inductor

形名中□には電極材質、二次加工の記号が入ります。品名構成の欄をご確認下さい。

The codes for electrode material and taping enter □. Please confirm the column of type designation.

形名中□にはインダクタンス許容差記号(B、C、G、J)が入ります。 The code for inductance tolerance (B, C, G, J) enters □.

## ■使用上の注意 Precautions for Use

- ランドパターンの大きさによりQ値に影響が生じますので、事前の実機にて特性をご確認下さい。
- The pattern size of pad may affect Q values, so confirm the characteristics beforehand by actual machines.

# THIN FILM INDUCTORS

## KL73 薄膜チップインダクタ Thin Film Chip Inductors

### ■定格(続き) Ratings (Continued)

使用温度範囲 Operating temperature range - 40 ~ + 125

テーピング記号と包装数/リール Taping code and Qty/Reel 1J, 2A : TE (4,000pcs)

形名 Type	表示 Marking	公称インダクタンス Nominal Inductance (nH)	インダクタンス許容差 Inductance Tolerance	Q値 Quality Factor Min.	自己共振周波数 Self Resonant Frequency (MHz) Min.	直流抵抗 DC Resistance (Ω) Max.	許容直流電流 Allowable DC Current (mA) Max.	測定周波数 Measuring Frequency (MHz)
KL73 1J□1N0C	L1	1.0	C : ±0.2nH	10	13,000	0.10	650	500
KL73 1J□1N2C	L2	1.2		15				
KL73 1J□1N5C	L3	1.5		20	10,000	0.15	450	
KL73 1J□1N8C	L4	1.8						
KL73 1J□2N2C	22	2.2			8,000	0.25	350	
KL73 1J□2N7C	27	2.7						
KL73 1J□3N3C	33	3.3			5,000	0.50	250	
KL73 1J□3N9C	39	3.9						
KL73 1J□4N7C	47	4.7			4,000	1.00	200	
KL73 1J□5N6□	56	5.6						
KL73 1J□6N8□	68	6.8	3,000	1.50	150			
KL73 1J□8N2□	82	8.2						
KL73 1J□10N□	10	10	2,500	2.50	120			
KL73 1J□12N□	12	12						
KL73 1J□15N□	15	15	2,000	4.00	100			
KL73 1J□18N□	H1	18						
KL73 1J□22N□	H2	22	1,500	5.00	90			
KL73 1J□27N□	H3	27						
KL73 1J□33N□	H4	33	1,000	1.50	200			
KL73 1J□39N□	H5	39						
KL73 1J□47N□	H6	47	600	4.00	150			
KL73 1J□56N□	H7	56						
KL73 1J□68N□	H8	68	500	5.00	100			
KL73 1J□82N□	H9	82						
KL73 2A□1N0C	1.0	1.0	C : ±0.2nH	20	13,000	0.25	900	500
KL73 2A□1N2C	1.2	1.2			10,000			
KL73 2A□1N5C	1.5	1.5		9,000		800		
KL73 2A□1N8C	1.8	1.8						
KL73 2A□2N2C	2.2	2.2		8,000	700			
KL73 2A□2N7C	2.7	2.7						
KL73 2A□3N3C	3.3	3.3		6,000	500			
KL73 2A□3N9C	3.9	3.9						
KL73 2A□4N7C	4.7	4.7		5,000	400			
KL73 2A□5N6□	5.6	5.6						
KL73 2A□6N8□	6.8	6.8	4,500	300				
KL73 2A□8N2□	8.2	8.2						
KL73 2A□10N□	10	10	4,000	250				
KL73 2A□12N□	12	12						
KL73 2A□15N□	15	15	3,000	200				
KL73 2A□18N□	18	18						
KL73 2A□22N□	22	22	2,500	150				
KL73 2A□27N□	27	27						
KL73 2A□33N□	33	33	2,000	90				
KL73 2A□39N□	39	39						
KL73 2A□47N□	47	47	1,500	80				
KL73 2A□56N□	56	56						
KL73 2A□68N□	68	68	1,000	4.00				
KL73 2A□82N□	82	82						
KL73 2A□82N□	82	82	800	5.00				
KL73 2A□82N□	82	82						

形名中□には電極材質、二次加工の記号が入ります。品名構成の欄をご確認下さい。

The codes for electrode material and taping enter □. Please confirm the column of type designation.

形名中□にはインダクタンス許容差記号(G, J)が入ります。 The code for inductance tolerance (G, J) enters □.

## ■定格(続き) Ratings (Continued)

使用温度範囲 Operating temperature range - 40 ~ + 125

テーピング記号と包装数/リール Taping code and Q'ty/Reel 2B : TE (4,000pcs)

形名 Type	表示 Marking	公称インダクタンス Nominal Inductance (nH)	インダクタンス許容差 Inductance Tolerance	Q値 Quality Factor Min.	自己共振周波数 Self Resonant Frequency (MHz) Min.	直流抵抗 DC Resistance (Ω) Max.	許容直流電流 Allowable DC Current (mA) Max.	測定周波数 Measuring Frequency (MHz)
KL73 2B 2N2C	2N2	2.2	C : ± 0.2nH	25	9,000	0.25	1,000	500
KL73 2B 2N7C	2N7	2.7			7,000			
KL73 2B 3N3C	3N3	3.3			6,000			
KL73 2B 3N9C	3N9	3.9			5,000			
KL73 2B 4N7C	4N7	4.7			4,500			
KL73 2B 5N6	5N6	5.6		35	4,000	0.50	900	
KL73 2B 6N8	6N8	6.8			3,500			
KL73 2B 8N2	8N2	8.2			3,000			
KL73 2B 10N	10N	10			2,500			
KL73 2B 12N	12N	12			2,000			
KL73 2B 15N	15N	15	40	1,500	1.00	500		
KL73 2B 18N	18N	18		1,000				
KL73 2B 22N	22N	22		500				
KL73 2B 27N	27N	27		400				
KL73 2B 33N	33N	33		200				
KL73 2B 39N	39N	39	25	1,000	2.00	400		
KL73 2B 47N	47N	47		500				
KL73 2B 56N	56N	56		400				
KL73 2B 68N	68N	68		200				
KL73 2B 82N	82N	82		200				
KL73 2B 100	100	100	15	400	2.00	200		
KL73 2B 100	100	100		400				

形名中□には電極材質、二次加工の記号が入ります。品名構成の欄をご確認下さい。

The codes for electrode material and taping enter □. Please confirm the column of type designation.

形名中□にはインダクタンス許容差記号(G, J)が入ります。 The code for inductance tolerance (G, J) enters □.

## ■特性 Characteristics

測定器

Test equipment Agilent E4991A impedance analyzer (1H)

Test equipment HP4291B impedance analyzer (1E, 1J, 2A, 2B)

L - f 特性 L - Frequency Characteristics

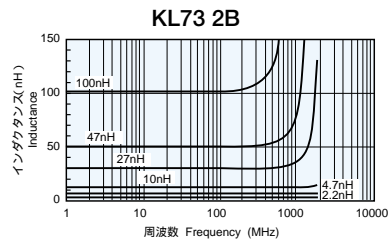
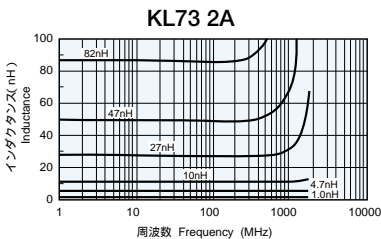
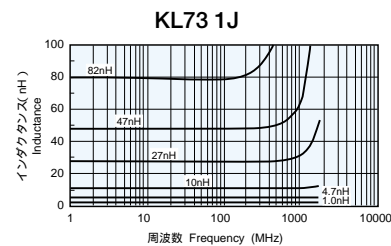
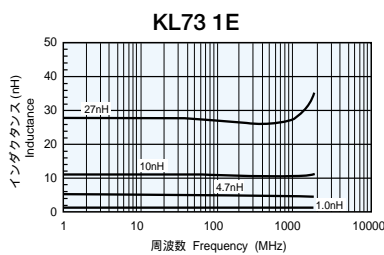
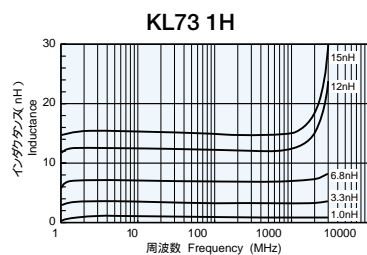

Q - f 特性 Q - Frequency Characteristics

