



Surface Mount Plastic PIN Diodes



Features

- Surface Mount Package
- Low Capacitance Diodes
- Low Loss Switch Diodes
- Low Distortion Attenuator Diodes
- Lowest I_R in Industry
- Fast Switching Diodes
- Single and Dual Diode Configurations
- Tape and Reel Packaging Available

Description

M/A-COM offers six PIN diodes in four industry standard low cost surface mount plastic packages. Within this series, the PIN diodes offered feature low resistance, low capacitance and long minority carrier lifetime.

The MA4P275 has the lowest resistance. The MA4P789 has the lowest capacitance and offers the highest isolation in series switches through S-band. The MA4P277 and MA4P278 PINs have thick intrinsic layers to produce better distortion performance in attenuators. The MA4P282 and MA4P274 are general purpose PIN diodes useful for either switches or attenuators. These parts are available as single diodes, series pairs, reverse series pairs (on special order), common cathode pairs, common anode pairs and unconnected pairs in the appropriate packages.

The SMPP series of PIN diodes is available in the SOT-23 (case style 287), the SOT-143 (case style 1068), the SOT-323 (case style 1146) and the SOD-323 (case style 1141) packages. These packages are supplied on tape and reel for automatic pick and place assembly on surface mount circuit boards, as indicated by a "T" to the case style suffix.

Package Outlines

SOT-23

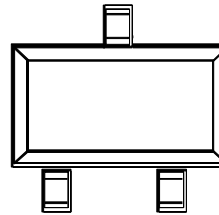

SOT-143

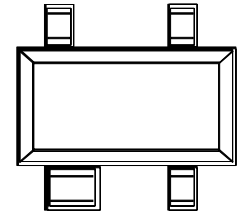

SOT-323

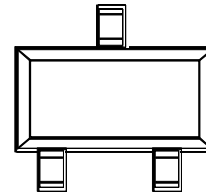

SOD-323

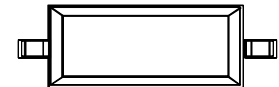

Configurations (Top View)

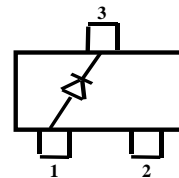

Single

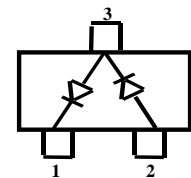

Series Pair

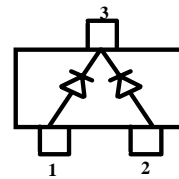

Common Cathode

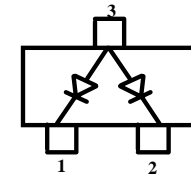

Common Anode

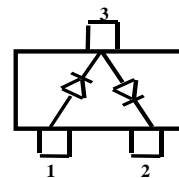

Series Pair Reverse

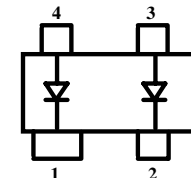

Unconnected Pair

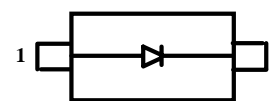

Single

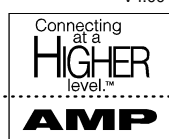

SOT-23**Electrical Specifications @ 25°C****SOT-23 Single Diode**

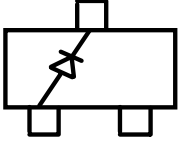
Model Number	Reverse Voltage V_R^1 (Volts)	Maximum Total Capacitance ² (pF)	Maximum R_S @ 10 mA ³ (Ohms)	Nominal Characteristics		SOT-23
				Carrier Lifetime ⁴ (μ s)	I-Region Thickness (mils)	
MA4P275-287	35	1.00 @ 20V	0.5	0.2	0.4	
MA4P789-287	50	0.35 @ 20V	1.5	0.2	0.4	
MA4P282-287	100	1.20 @ 20V	0.6	1.0	0.8	
MA4P274-287	100	0.35 @ 50V	3.0	1.0	2.0	
MA4P277-287	200	0.35 @ 50V	6.0	2.0	4.0	
MA4P278-287	200	0.35 @ 50V	10.0	3.0	5.0	

SOT-23 Series Pair⁵

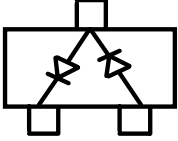
Model Number	Reverse Voltage V_R^1 (Volts)	Maximum Total Capacitance ² (pF)	Maximum R_S @ 10 mA ³ (Ohms)	Nominal Characteristics		SOT-23
				Carrier Lifetime ⁴ (μ s)	I-Region Thickness (mils)	
MA4P275ST-287	35	1.00 @ 20V	0.5	0.2	0.4	
MA4P789ST-287	50	0.35 @ 20V	1.5	0.2	0.4	
MA4P274ST-287	100	0.35 @ 50V	3.0	1.0	2.0	
MA4P282ST-287	100	1.20 @ 20V	0.6	1.0	0.8	
MA4P277ST-287	200	0.35 @ 50V	6.0	2.0	4.0	
MA4P278ST-287	200	0.35 @ 50V	10.0	3.0	5.0	

SOT-23 Common Cathode

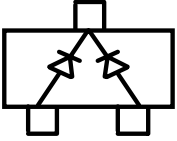
Model Number	Reverse Voltage V_R^1 (Volts)	Maximum Total Capacitance ² (pF)	Maximum R_S @ 10 mA ³ (Ohms)	Nominal Characteristics		SOT-23
				Carrier Lifetime ⁴ (μ s)	I-Region Thickness (mils)	
MA4P275CK-287	35	1.00 @ 20V	0.5	0.2	0.4	
MA4P789CK-287	50	0.35 @ 20V	1.5	0.2	0.4	
MA4P274CK-287	100	0.35 @ 50V	3.0	1.0	2.0	
MA4P282CK-287	100	1.20 @ 20V	0.6	1.0	0.8	
MA4P277CK-287	200	0.35 @ 50V	6.0	2.0	4.0	
MA4P278CK-287	200	0.35 @ 50V	10.0	3.0	5.0	

SOT-23 Common Anode

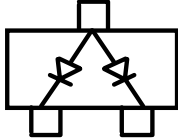
Model Number	Reverse Voltage V_R^1 (Volts)	Maximum Total Capacitance ² (pF)	Maximum R_S @ 10 mA ³ (Ohms)	Nominal Characteristics		SOT-23
				Carrier Lifetime ⁴ (μ s)	I-Region Thickness (mils)	
MA4P275CA-287	35	1.00 @ 20V	0.5	0.2	0.4	
MA4P789CA-287	50	0.35 @ 20V	1.5	0.2	0.4	
MA4P282CA-287	100	1.20 @ 20V	0.6	1.0	0.8	
MA4P274CA-287	100	0.35 @ 50V	3.0	1.0	2.0	
MA4P277CA-287	200	0.35 @ 50V	6.0	2.0	4.0	
MA4P278CA-287	200	0.35 @ 50V	10.0	3.0	5.0	

1. The reverse current will not exceed 10 μ A at the Reverse Voltage rating.
2. Maximum total capacitance is measured at 1 MHz at the indicated voltage.
3. Maximum series resistance is measured at the specified current and a frequency of 100 MHz.
4. Nominal minority lifetime is measured at $I_f = 10$ mA, $I_r = 6$ mA, 90% recovery.
5. Also available as reverse polarity series pairs. Designated as "MA4P275STR-287", etc.

SOT-323**Electrical Specifications @ 25°C****SOT-323 Single Diode**

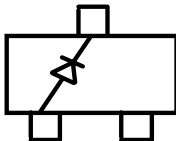
Model Number	Reverse Voltage V_R ¹ (Volts)	Maximum Total Capacitance ² (pF)	Maximum R_s @ 10 mA ³ (Ohms)	Nominal Characteristics		SOT-323
				Carrier Lifetime ⁴ (μ s)	I-Region Thickness (mils)	
MA4P275-1146	35	1.00 @ 20V	0.5	0.2	0.4	
MA4P789-1146	50	0.35 @ 20V	1.5	0.2	0.4	
MA4P274-1146	100	0.35 @ 50V	3.0	1.0	2.0	

SOT-323 Series Pair⁵

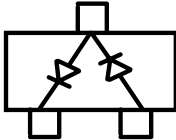
Model Number	Reverse Voltage V_R ¹ (Volts)	Maximum Total Capacitance ² (pF)	Maximum R_s @ 10 mA ³ (Ohms)	Nominal Characteristics		SOT-323
				Carrier Lifetime ⁴ (μ s)	I-Region Thickness (mils)	
MA4P275ST-1146	35	1.00 @ 20V	0.5	0.2	0.4	
MA4P789ST-1146	50	0.35 @ 20V	1.5	0.2	0.4	
MA4P274ST-1146	100	0.35 @ 50V	3.0	1.0	2.0	

SOT-323 Common Cathode

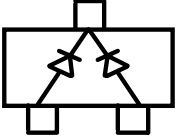
Model Number	Reverse Voltage V_R ¹ (Volts)	Maximum Total Capacitance ² (pF)	Maximum R_s @ 10 mA ³ (Ohms)	Nominal Characteristics		SOT-323
				Carrier Lifetime ⁴ (μ s)	I-Region Thickness (mils)	
MA4P275CK-1146	35	1.00 @ 20V	0.5	0.2	0.4	
MA4P789CK-1146	50	0.35 @ 20V	1.5	0.2	0.4	
MA4P274CK-1146	100	0.35 @ 50V	3.0	1.0	2.0	

SOT-323 Common Anode

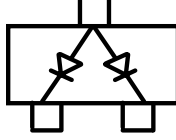
Model Number	Reverse Voltage V_R ¹ (Volts)	Maximum Total Capacitance ² (pF)	Maximum R_s @ 10 mA ³ (Ohms)	Nominal Characteristics		SOT-323
				Carrier Lifetime ⁴ (μ s)	I-Region Thickness (mils)	
MA4P275CA-1146	35	1.00 @ 20V	0.5	0.2	0.4	
MA4P789CA-1146	50	0.35 @ 20V	1.5	0.2	0.4	
MA4P274CA-1146	100	0.35 @ 50V	3.0	1.0	2.0	

1. The reverse current will not exceed 10 μ A at the Reverse Voltage rating.
2. Maximum total capacitance is measured at 1 MHz at the indicated voltage.
3. Maximum series resistance is measured at the specified current and a frequency of 100 MHz.
4. Nominal minority lifetime is measured at $I_F = 10$ mA, $I_R = 6$ mA, 90% recovery.
5. Also available as reverse polarity series pairs. Designated as "MA4P275STR-1146", etc.

SOD-323**Electrical Specifications @ 25°C****SOD-323 Single Diode**

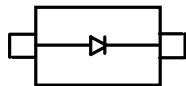
Model Number	Reverse Voltage V_R^1 (Volts)	Maximum Total Capacitance ² (pF)	Maximum R_S @ 10 mA ³ (Ohms)	Nominal Characteristics		SOD-323
				Carrier Lifetime ⁴ (μ s)	I-Region Thickness (mils)	
MA4P275-1141	35	1.00 @ 20V	0.5	0.2	0.4	
MA4P789-1141	50	0.35 @ 20V	1.5	0.2	0.4	
MA4P282-1141	100	1.20 @ 20V	0.6	1.0	0.8	
MA4P274-1141	100	0.35 @ 50V	3.0	1.0	2.0	
MA4P277-1141	200	0.35 @ 50V	6.0	2.0	4.0	
MA4P278-1141	200	0.35 @ 50V	10.0	3.0	5.0	

1. The reverse current will not exceed 10 μ A at the Reverse Voltage rating.
2. Maximum total capacitance is measured at 1 MHz at the indicated voltage.
3. Maximum series resistance is measured at the specified current and a frequency of 100 MHz.
4. Nominal minority lifetime is measured at $I_F = 10$ mA, $I_R = 6$ mA, 90% recovery.

SOT-143**Electrical Specifications @ 25°C****SOT-143 Unconnected Pair**

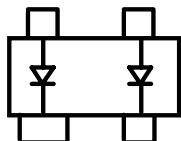
Model Number	Reverse Voltage V_R^1 (Volts)	Maximum Total Capacitance ² (pF)	Maximum R_S @ 10 mA ³ (Ohms)	Nominal Characteristics		SOT-143
				Carrier Lifetime ⁴ (μ s)	I-Region Thickness (mils)	
MA4P275-1068	35	1.00 @ 20V	0.5	0.2	0.4	
MA4P789-1068	50	0.35 @ 20V	1.5	0.2	0.4	
MA4P274-1068	100	0.35 @ 50V	3.0	1.0	2.0	

1. The reverse current will not exceed 10 μ A at the Reverse Voltage rating.
2. Maximum total capacitance is measured at 1 MHz at the indicated voltage.
3. Maximum series resistance is measured at the specified current and a frequency of 100 MHz.
4. Nominal minority lifetime is measured at $I_F = 10$ mA, $I_R = 6$ mA, 90% recovery.

Absolute Maximum Ratings at 25°C

Parameter	Absolute Maximum
Operating Temperature	-65°C to +125°C
Storage Temperature	-65°C to +125°C
Power Dissipation at +25°C ambient	
SOT-23, SOT-143	250 mW
SOT-323, SOD-323	150 mW
Reverse Voltage	Voltage Rating
Forward Current	100 mA _{dc}

Typical Resistance Curves at 100 MHz

Resistance vs Forward Current
(MA4P274 Series)

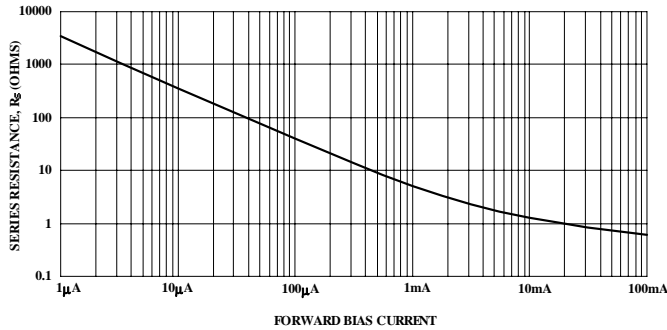

Resistance vs Forward Current
(MA4P275 Series)

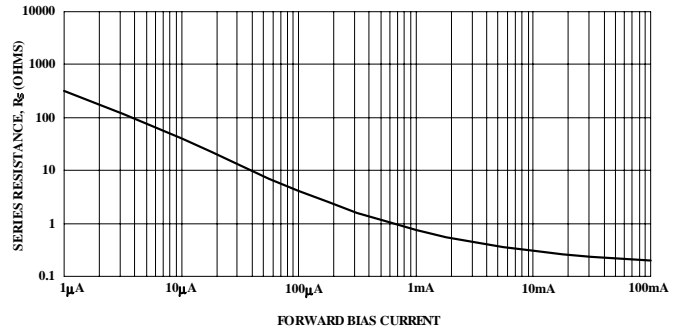

Resistance vs Forward Current
(MA4P277 Series)

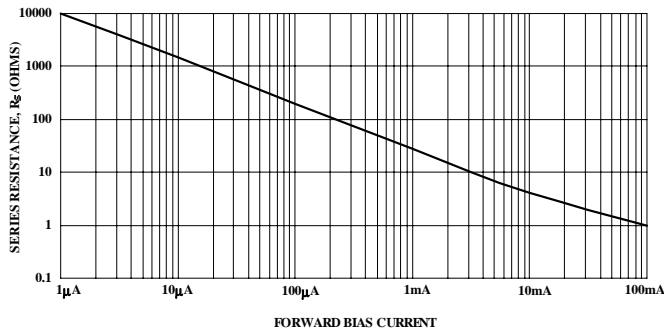

Resistance vs Forward Current
(MA4P278 Series)

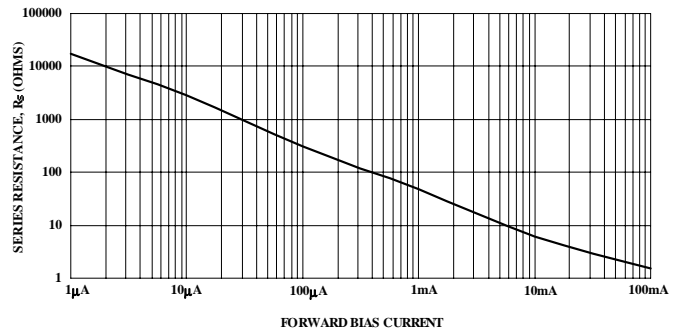

Resistance vs Forward Current
(MA4P282 Series)

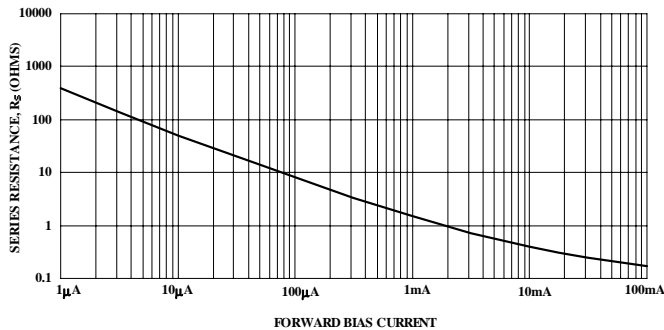

Resistance vs Forward Current
(MA4P789 Series)

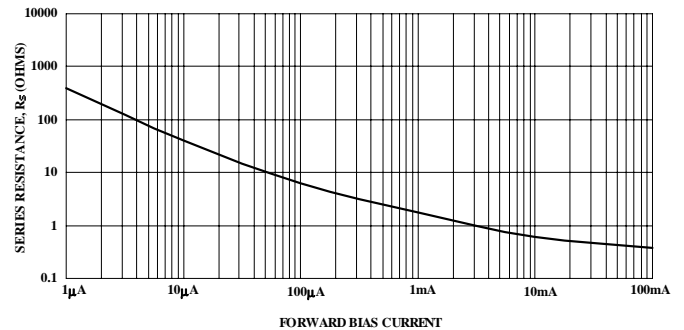

PIN Diode Cross Reference

Many of M/A-COM's glass axial lead hermetic surface mount and plastic PIN diodes use similar chips and, therefore, have the same electrical characteristics, except for package parasitics.

The following table lists the SOT-23, SOT-323 and SOD-323 PIN diodes by model number and standard axial lead PIN diode and the equivalent square surface mount (SMQ) PIN diodes.

SOT-23 Diodes	Axial Lead Glass Diodes	SMQ Diodes
MA4P274-287	MA47123	MA4PH236
MA4P275-287	MA4P270	MA4PH235
MA4P277-287	MA47110	MA4PH238
MA4P278-287	MA47100	—
MA4P282-287	MA4PH151	—
MA4P789-287	MA4PH401	—

SOT-323 Diodes	Axial Lead Glass Diodes	SMQ Diodes
MA4P274-1146	MA47123	MA4PH236
MA4P275-1146	MA4P270	MA4PH235
—	MA47110	MA4PH238
—	MA47100	—
—	MA4PH151	—
MA4P789-1146	MA4PH401	—

SOD-323 Diodes	Axial Lead Glass Diodes	SMQ Diodes
MA4P274-1141	MA47123	MA4PH236
MA4P275-1141	MA4P270	MA4PH235
MA4P277-1141	MA47110	MA4PH238
MA4P278-1141	MA47100	—
MA4P282-1141	MA4PH151	—
MA4P789-1141	MA4PH401	—

Mounting Information

The illustration indicates the recommended mounting pad configuration for the SOT-23, SOT-323 and SOD-323 packages. Solder paste containing flux should be screened onto the pads to a thickness of 0.005 inches. The plastic package device is placed in position, firmly adhering to the solder past.

Permanent attachment is performed by a reflow soldering procedure during which the tab temperature does not exceed +275°C and the body temperature does not exceed +250°C.

SOT-23

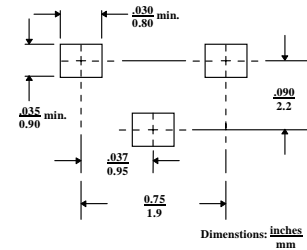

SOT-323

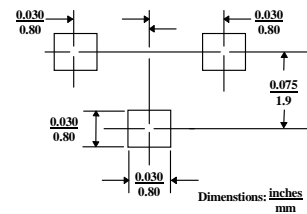

SOD-323

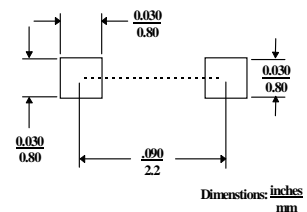

SOT-143

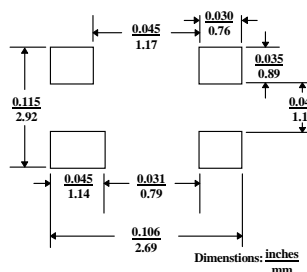

Case Styles

SOT-23
Case Style 287

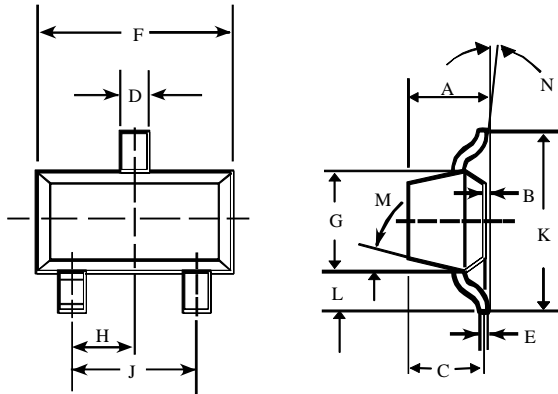

SOT-23 (Case Style 287)

DIM.	INCHES		MILLIMETERS	
	MIN.	MAX.	MIN.	MAX.
A	—	0.048	—	1.22
B	—	0.008	—	0.20
C	—	0.040	—	1.00
D	0.013	0.020	0.35	0.50
E	0.003	0.006	0.08	0.15
F	0.110	0.119	2.80	3.00
G	0.047	0.056	1.20	1.40
H	0.037 typical		0.95 typical	
J	0.075 typical		1.90 typical	
K	—	0.103	—	2.60
L	—	0.024	—	0.60

DIM.	GRADIENT
M	10° max. ¹
N	2° . . . 30°

NOTE:
1. Applicable on all sides

SOT-323
Case Style 1146

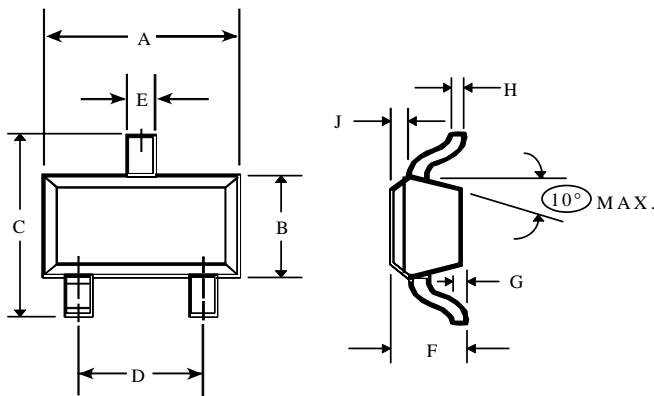

SOT-323 (Case Style 1146)

DIM.	INCHES		MILLIMETERS	
	MIN.	MAX.	MIN.	MAX.
A	0.063	0.087	1.6	2.2
B	0.045	0.053	1.15	1.35
C	0.079	0.087	2.0	2.2
D	0.047	0.055	1.2	1.4
E	0.008	0.016	0.2	0.4
F	0.031	0.039	0.8	1.0
G	—	0.004	—	0.1
H	0.003	0.006	0.08	0.15
J	0.004	0.010	0.1	0.25

Case Styles (Cont'd)

SOD-323
Case Style 1141

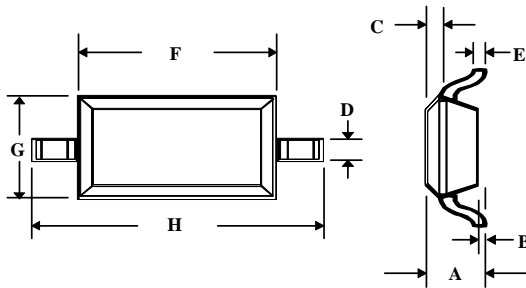

SOD-323 (Case Style 1141)

DIM.	INCHES		MILLIMETERS	
	MIN.	MAX.	MIN.	MAX.
A	—	0.043	—	1.1
B	—	0.004	—	0.1
C	—	0.008	—	0.2
D	0.010	0.016	0.25	0.4
E	0.003	0.006	0.08	0.15
F	0.063	0.075	1.6	1.9
G	0.045	0.057	1.15	1.45
H	0.091	0.106	2.3	2.7

SOT-143
Case Style 1068

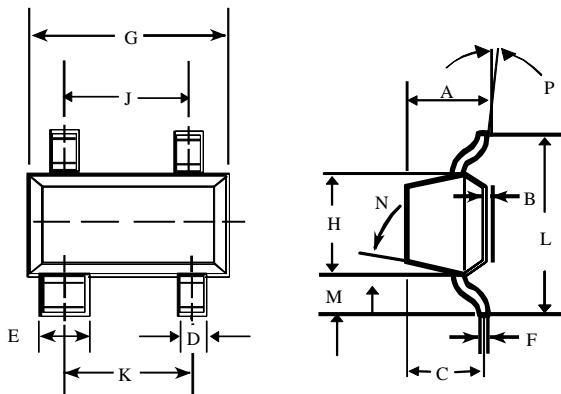

SOT-143 (Case Style 1068)

DIM.	INCHES		MILLIMETERS	
	MIN.	MAX.	MIN.	MAX.
A	—	0.044	—	1.10
B	—	0.004	—	0.10
C	—	0.040	—	1.00
D	0.013	0.020	0.35	0.50
E	0.030	0.035	0.75	0.90
F	0.003	0.006	0.08	0.15
G	0.110	0.119	2.80	3.00
H	0.047	0.056	1.20	1.40
J	0.075 typical		1.90 typical	
K	0.075 typical		1.90 typical	
L	—	0.103	—	2.6
M	—	0.024	—	0.6

DIM.	GRADIENT
M	10° max. ¹
N	2° . . . 30°

NOTE:
1. Applicable on all sides