

TISP4070M3BJ THRU TISP4115M3BJ, TISP4125M3BJ THRU TISP4220M3BJ, TISP4240M3BJ THRU TISP4400M3BJ BIDIRECTIONAL THYRISTOR OVERVOLTAGE PROTECTORS

Copyright © 2000, Power Innovations Limited, UK

NOVEMBER 1997 - REVISED OCTOBER 2000

TELECOMMUNICATION SYSTEM 50 A 10/1000 OVERVOLTAGE PROTECTORS

- 4 kV 10/700, 100 A 5/310 ITU-T K.20/21 rating
- Ion-Implanted Breakdown Region
Precise and Stable Voltage
Low Voltage Overshoot under Surge

DEVICE	V _{DRM} V	V _(BO) V
'4070	58	70
'4080	65	80
'4095	75	95
'4115	90	115
'4125	100	125
'4145	120	145
'4165	135	165
'4180	145	180
'4200	155	200
'4220	160	220
'4240	180	240
'4250	190	250
'4265	200	265
'4290	220	290
'4300	230	300
'4350	275	350
'4395	320	395
'4400	300	400

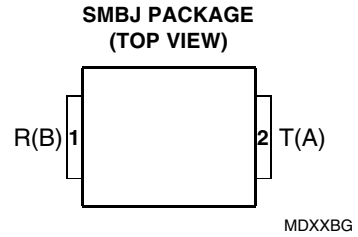

device symbol



Terminals T and R correspond to the alternative line designators of A and B

- Rated for International Surge Wave Shapes

WAVE SHAPE	STANDARD	I _{TSP} A
2/10 μs	GR-1089-CORE	300
8/20 μs	IEC 61000-4-5	220
10/160 μs	FCC Part 68	120
10/700 μs	ITU-T K.20/21	100
10/560 μs	FCC Part 68	75
10/1000 μs	GR-1089-CORE	50

- Low Differential Capacitance . . . 43 pF max.
- UL Recognized Component.

HOW TO ORDER

DEVICE	PACKAGE	CARRIER	ORDER AS
TISP4xxxM3BJ	BJ (J-Bend DO-214AA/SMB)	Embossed Tape Reeled	TISP4xxxM3BJR
		Bulk Pack	TISP4xxxM3BJ

Insert xxx value corresponding to protection voltages of 070, 080, 095, 115 etcetera.

description

These devices are designed to limit overvoltages on the telephone line. Overvoltages are normally caused by a.c. power system or lightning flash disturbances which are induced or conducted on to the telephone line. A single device provides 2-point protection and is typically used for the protection of 2-wire telecommunication equipment (e.g. between the Ring and Tip wires for telephones and modems). Combinations of devices can be used for multi-point protection (e.g. 3-point protection between Ring, Tip and Ground).

PRODUCT INFORMATION

Information is current as of publication date. Products conform to specifications in accordance with the terms of Power Innovations standard warranty. Production processing does not necessarily include testing of all parameters.

TISP4070M3BJ THRU TISP4115M3BJ, TISP4125M3BJ THRU TISP4220M3BJ, TISP4240M3BJ THRU TISP4400M3BJ BIDIRECTIONAL THYRISTOR OVERVOLTAGE PROTECTORS

NOVEMBER 1997 - REVISED OCTOBER 2000

The protector consists of a symmetrical voltage-triggered bidirectional thyristor. Overvoltages are initially clipped by breakdown clamping until the voltage rises to the breakover level, which causes the device to crowbar into a low-voltage on state. This low-voltage on state causes the current resulting from the overvoltage to be safely diverted through the device. The high crowbar holding current prevents d.c. latchup as the diverted current subsides.

The TISP4xxxM3BJ range consists of eighteen voltage variants to meet various maximum system voltage levels (58 V to 320 V). They are guaranteed to voltage limit and withstand the listed international lightning surges in both polarities. These medium (M) current protection devices are in a plastic package SMBJ (JEDEC DO-214AA with J-bend leads) and supplied in embossed tape reel pack. For alternative voltage and holding current values, consult the factory. For higher rated impulse currents in the SMB package, the 100 A 10/1000 TISP4xxxH3BJ series is available.

absolute maximum ratings, $T_A = 25\text{ }^\circ\text{C}$ (unless otherwise noted)

RATING	SYMBOL	VALUE	UNIT	
Repetitive peak off-state voltage, (see Note 1)	'4070	± 58	V	
	'4080	± 65		
	'4095	± 75		
	'4115	± 90		
	'4125	± 100		
	'4145	± 120		
	'4165	± 135		
	'4180	± 145		
	'4200	± 155		
	'4220	± 160		
	'4240	± 180		
	'4250	± 190		
	'4265	± 200		
	'4290	± 220		
	'4300	± 230		
	'4350	± 275		
	'4395	± 320		
	'4400	± 300		
Non-repetitive peak on-state pulse current (see Notes 2, 3 and 4)	I_{TSP}		A	
2/10 μs (GR-1089-CORE, 2/10 μs voltage wave shape)				300
8/20 μs (IEC 61000-4-5, combination wave generator, 1.2/50 voltage, 8/20 current)				220
10/160 μs (FCC Part 68, 10/160 μs voltage wave shape)				120
5/200 μs (VDE 0433, 10/700 μs voltage wave shape)				110
0.2/310 μs (I3124, 0.5/700 μs voltage wave shape)				100
5/310 μs (ITU-T K.20/21, 10/700 μs voltage wave shape)				100
5/310 μs (FTZ R12, 10/700 μs voltage wave shape)				100
10/560 μs (FCC Part 68, 10/560 μs voltage wave shape)				75
10/1000 μs (GR-1089-CORE, 10/1000 μs voltage wave shape)				50

- NOTES: 1. See Applications Information and Figure 10 for voltage values at lower temperatures.
 2. Initially the TISP4xxxM3BJ must be in thermal equilibrium with $T_J = 25\text{ }^\circ\text{C}$.
 3. The surge may be repeated after the TISP4xxxM3BJ returns to its initial conditions.
 4. See Applications Information and Figure 11 for current ratings at other temperatures.

PRODUCT INFORMATION

**TISP4070M3BJ THRU TISP4115M3BJ, TISP4125M3BJ THRU TISP4220M3BJ,
TISP4240M3BJ THRU TISP4400M3BJ
BIDIRECTIONAL THYRISTOR OVERVOLTAGE PROTECTORS**

NOVEMBER 1997 - REVISED OCTOBER 2000

absolute maximum ratings, $T_A = 25\text{ }^\circ\text{C}$ (unless otherwise noted) (continued)

RATING	SYMBOL	VALUE	UNIT
Non-repetitive peak on-state current (see Notes 2, 3 and 5) 20 ms (50 Hz) full sine wave 16.7 ms (60 Hz) full sine wave 1000 s 50 Hz/60 Hz a.c.	I_{TSM}	30	A
		32	
		2.1	
Initial rate of rise of on-state current, Exponential current ramp, Maximum ramp value < 100 A	di_T/dt	300	A/ μ s
Junction temperature	T_J	-40 to +150	$^\circ\text{C}$
Storage temperature range	T_{stg}	-65 to +150	$^\circ\text{C}$

- NOTES: 2. Initially the TISP4xxxM3BJ must be in thermal equilibrium with $T_J = 25\text{ }^\circ\text{C}$.
 3. The surge may be repeated after the TISP4xxxM3BJ returns to its initial conditions.
 5. EIA/JESD51-2 environment and EIA/JESD51-3 PCB with standard footprint dimensions connected with 5 A rated printed wiring track widths. See Figure 8 for the current ratings at other durations. Derate current values at $-0.61\text{ }^\circ\text{C}$ for ambient temperatures above $25\text{ }^\circ\text{C}$

electrical characteristics, $T_A = 25\text{ }^\circ\text{C}$ (unless otherwise noted)

PARAMETER	TEST CONDITIONS	MIN	TYP	MAX	UNIT
I_{DRM} Repetitive peak off-state current	$V_D = V_{DRM}$			$T_A = 25\text{ }^\circ\text{C}$	± 5
				$T_A = 85\text{ }^\circ\text{C}$	± 10
$V_{(BO)}$ Breakover voltage	$dv/dt = \pm 750\text{ V/ms}$, $R_{SOURCE} = 300\ \Omega$			'4070	± 70
				'4080	± 80
				'4095	± 95
				'4115	± 115
				'4125	± 125
				'4145	± 145
				'4165	± 165
				'4180	± 180
				'4200	± 200
				'4220	± 220
				'4240	± 240
				'4250	± 250
				'4265	± 265
				'4290	± 290
				'4300	± 300
				'4350	± 350
'4395	± 395				
'4400	± 400				

**TISP4070M3BJ THRU TISP4115M3BJ, TISP4125M3BJ THRU TISP4220M3BJ,
TISP4240M3BJ THRU TISP4400M3BJ
BIDIRECTIONAL THYRISTOR OVERVOLTAGE PROTECTORS**

NOVEMBER 1997 - REVISED OCTOBER 2000

electrical characteristics, $T_A = 25\text{ }^\circ\text{C}$ (unless otherwise noted) (continued)

PARAMETER	TEST CONDITIONS	MIN	TYP	MAX	UNIT
$V_{(BO)}$ Impulse breakover voltage	dv/dt \leq $\pm 1000\text{ V}/\mu\text{s}$, Linear voltage ramp, Maximum ramp value = $\pm 500\text{ V}$ di/dt = $\pm 20\text{ A}/\mu\text{s}$, Linear current ramp, Maximum ramp value = $\pm 10\text{ A}$			± 78	V
		'4080		± 88	
		'4095		± 102	
		'4115		± 122	
		'4125		± 132	
		'4145		± 151	
		'4165		± 171	
		'4180		± 186	
		'4200		± 207	
		'4220		± 227	
		'4240		± 247	
		'4250		± 257	
		'4265		± 272	
		'4290		± 298	
		'4300		± 308	
'4350		± 359			
'4395		± 405			
'4400		± 410			
$I_{(BO)}$ Breakover current	dv/dt = $\pm 750\text{ V/ms}$, $R_{SOURCE} = 300\ \Omega$	± 0.15		± 0.6	A
V_T On-state voltage	$I_T = \pm 5\text{ A}$, $t_W = 100\ \mu\text{s}$			± 3	V
I_H Holding current	$I_T = \pm 5\text{ A}$, di/dt = $\pm 30\text{ mA/ms}$	± 0.15		± 0.6	A
dv/dt Critical rate of rise of off-state voltage	Linear voltage ramp, Maximum ramp value $< 0.85V_{DRM}$	± 5			kV/ μs
I_D Off-state current	$V_D = \pm 50\text{ V}$ $T_A = 85\text{ }^\circ\text{C}$			± 10	μA
C_{off} Off-state capacitance	f = 100 kHz, $V_d = 1\text{ V rms}$, $V_D = 0$, f = 100 kHz, $V_d = 1\text{ V rms}$, $V_D = -1\text{ V}$, f = 100 kHz, $V_d = 1\text{ V rms}$, $V_D = -2\text{ V}$, f = 100 kHz, $V_d = 1\text{ V rms}$, $V_D = -50\text{ V}$, f = 100 kHz, $V_d = 1\text{ V rms}$, $V_D = -100\text{ V}$ (see Note 6)	4070 thru '4115	86	110	pF
		'4125 thru '4220	60	80	
		'4240 thru '4400	54	70	
		'4070 thru '4115	80	96	
		'4125 thru '4220	56	74	
		'4240 thru '4400	50	64	
		'4070 thru '4115	74	90	
		'4125 thru '4220	52	70	
		'4240 thru '4400	46	60	
		'4070 thru '4115	36	47	
		'4125 thru '4220	26	36	
		'4240 thru '4400	20	30	
'4125 thru '4220	20	30			
'4240 thru '4400	16	24			

NOTE 6: To avoid possible voltage clipping, the '4125 is tested with $V_D = -98\text{ V}$.

thermal characteristics

PARAMETER	TEST CONDITIONS	MIN	TYP	MAX	UNIT
$R_{\theta JA}$ Junction to free air thermal resistance	EIA/JESD51-3 PCB, $I_T = I_{TSM(1000)}$, $T_A = 25\text{ }^\circ\text{C}$, (see Note 7)			115	$^\circ\text{C/W}$
	265 mm x 210 mm populated line card, 4-layer PCB, $I_T = I_{TSM(1000)}$, $T_A = 25\text{ }^\circ\text{C}$		52		

NOTE 7: EIA/JESD51-2 environment and PCB has standard footprint dimensions connected with 5 A rated printed wiring track widths.

PRODUCT INFORMATION

TISP4070M3BJ THRU TISP4115M3BJ, TISP4125M3BJ THRU TISP4220M3BJ,
TISP4240M3BJ THRU TISP4400M3BJ
BIDIRECTIONAL THYRISTOR OVERVOLTAGE PROTECTORS

NOVEMBER 1997 - REVISED OCTOBER 2000

PARAMETER MEASUREMENT INFORMATION

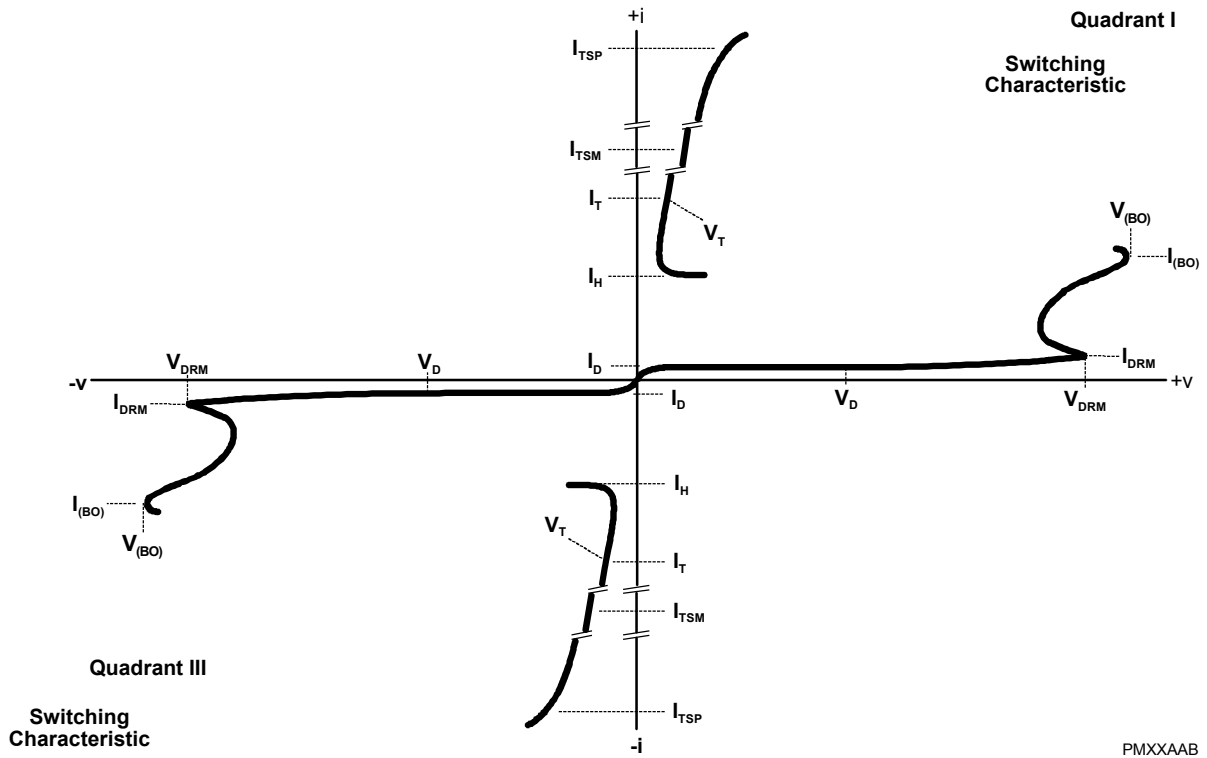

Figure 1. VOLTAGE-CURRENT CHARACTERISTIC FOR T AND R TERMINALS
ALL MEASUREMENTS ARE REFERENCED TO THE R TERMINAL

TISP4070M3BJ THRU TISP4115M3BJ, TISP4125M3BJ THRU TISP4220M3BJ,
 TISP4240M3BJ THRU TISP4400M3BJ
 BIDIRECTIONAL THYRISTOR OVERVOLTAGE PROTECTORS

NOVEMBER 1997 - REVISED OCTOBER 2000

TYPICAL CHARACTERISTICS

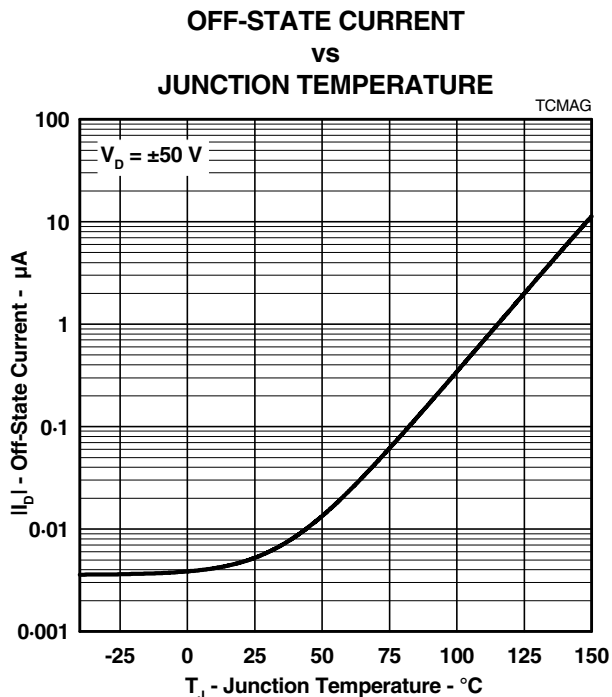

Figure 2.

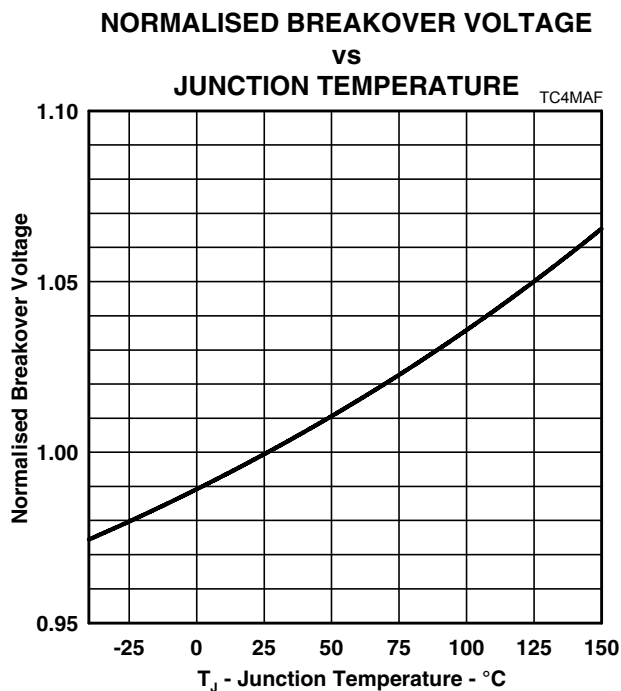

Figure 3.

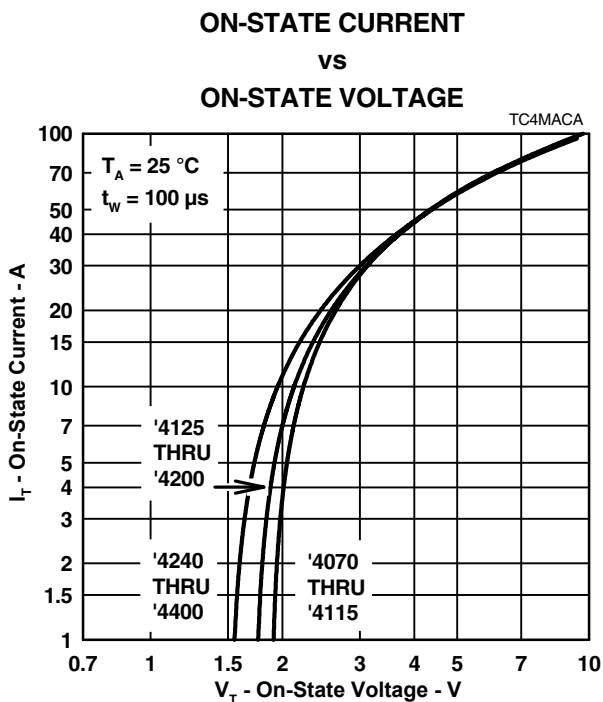

Figure 4.

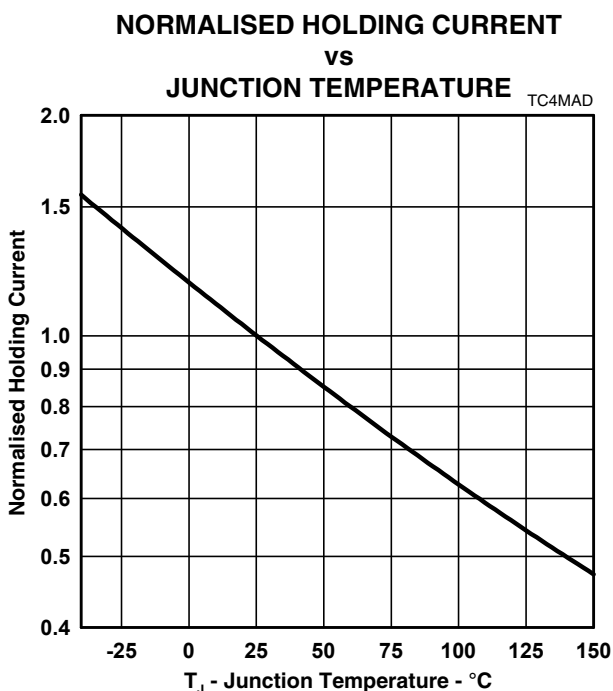

Figure 5.

PRODUCT INFORMATION

TISP4070M3BJ THRU TISP4115M3BJ, TISP4125M3BJ THRU TISP4220M3BJ,
TISP4240M3BJ THRU TISP4400M3BJ
BIDIRECTIONAL THYRISTOR OVERVOLTAGE PROTECTORS

NOVEMBER 1997 - REVISED OCTOBER 2000

TYPICAL CHARACTERISTICS

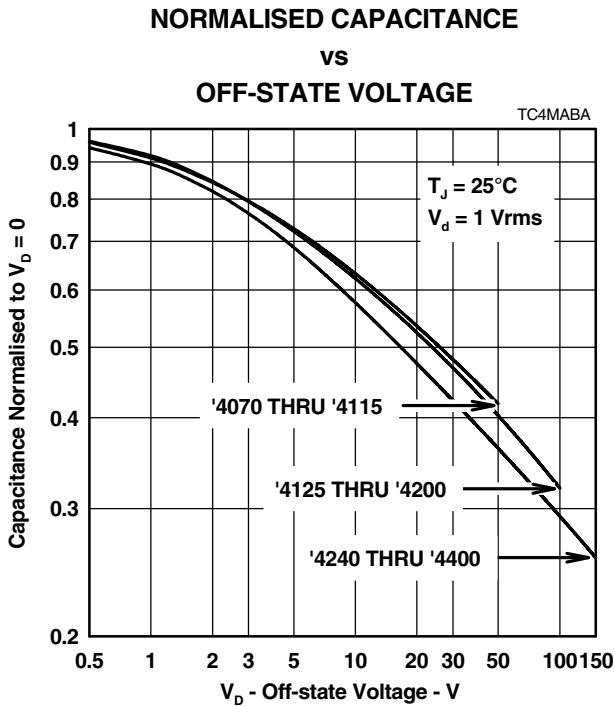

Figure 6.

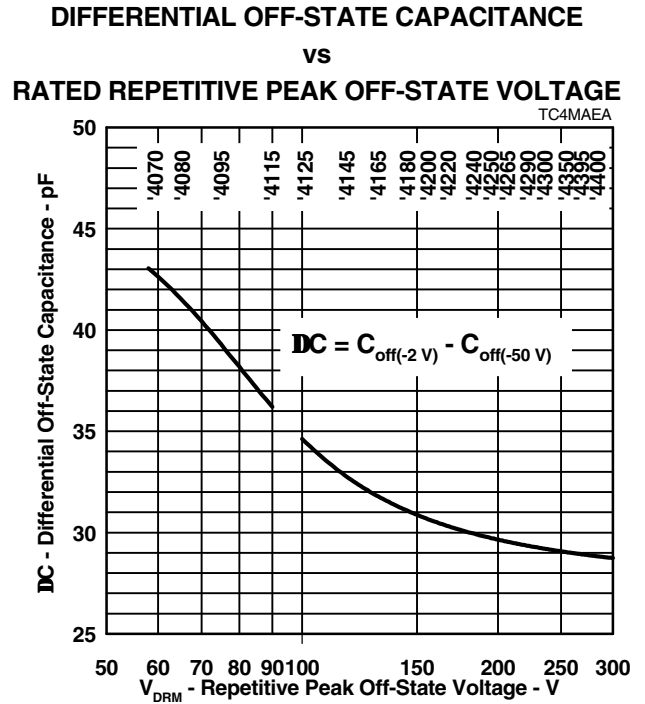

Figure 7.

**TISP4070M3BJ THRU TISP4115M3BJ, TISP4125M3BJ THRU TISP4220M3BJ,
TISP4240M3BJ THRU TISP4400M3BJ
BIDIRECTIONAL THYRISTOR OVERVOLTAGE PROTECTORS**

NOVEMBER 1997 - REVISED OCTOBER 2000

RATING AND THERMAL INFORMATION

**NON-REPETITIVE PEAK ON-STATE CURRENT
vs
CURRENT DURATION**

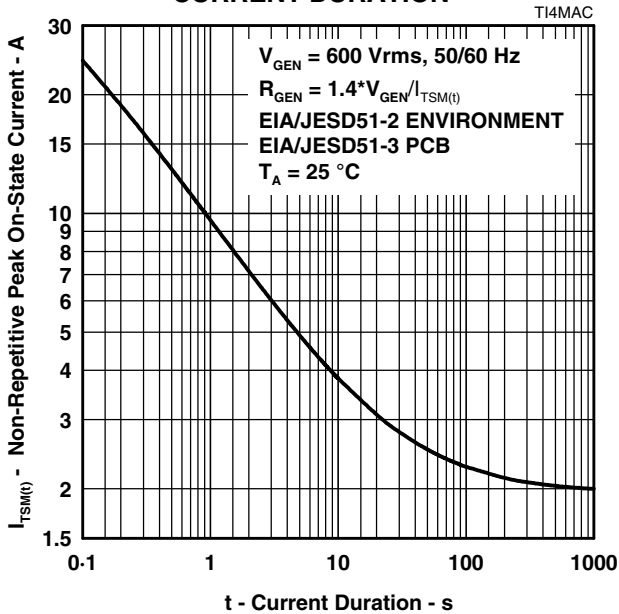

Figure 8.

**THERMAL IMPEDANCE
vs
POWER DURATION**

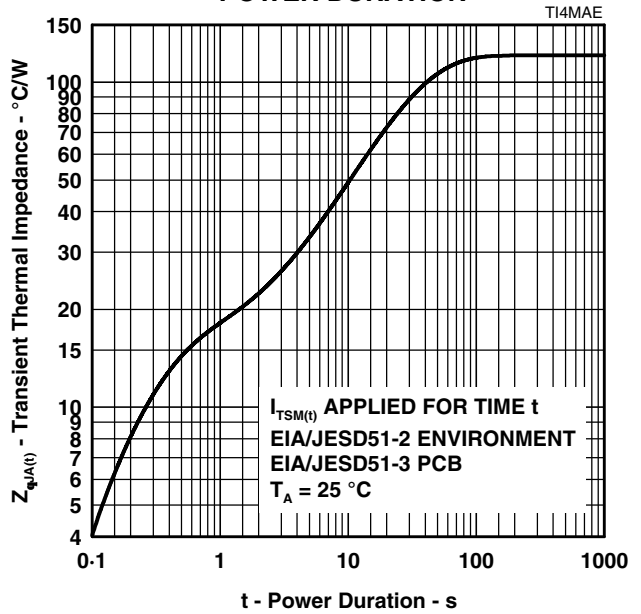

Figure 9.

**V_DRM DERATING FACTOR
vs
MINIMUM AMBIENT TEMPERATURE**

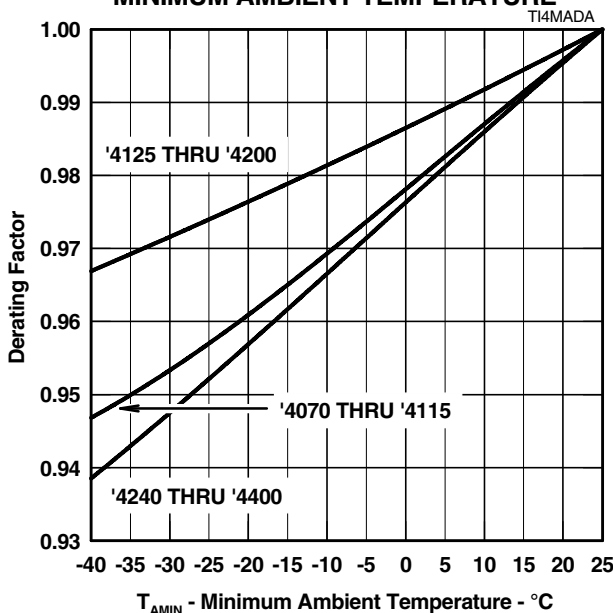

Figure 10.

**IMPULSE RATING
vs
AMBIENT TEMPERATURE**

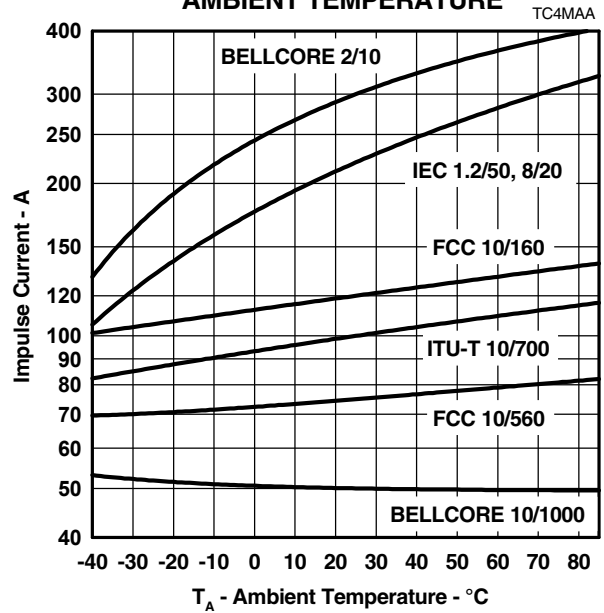

Figure 11.

PRODUCT INFORMATION

TISP4070M3BJ THRU TISP4115M3BJ, TISP4125M3BJ THRU TISP4220M3BJ, TISP4240M3BJ THRU TISP4400M3BJ BIDIRECTIONAL THYRISTOR OVERVOLTAGE PROTECTORS

NOVEMBER 1997 - REVISED OCTOBER 2000

APPLICATIONS INFORMATION

deployment

These devices are two terminal overvoltage protectors. They may be used either singly to limit the voltage between two conductors (Figure 12) or in multiples to limit the voltage at several points in a circuit (Figure 13).

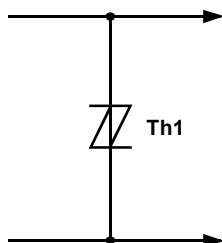

Figure 12. TWO POINT PROTECTION

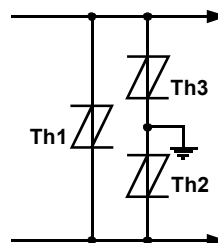

Figure 13. MULTI-POINT PROTECTION

In Figure 12, protector Th1 limits the maximum voltage between the two conductors to $\pm V_{(BO)}$. This configuration is normally used to protect circuits without a ground reference, such as modems. In Figure 13, protectors Th2 and Th3 limit the maximum voltage between each conductor and ground to the $\pm V_{(BO)}$ of the individual protector. Protector Th1 limits the maximum voltage between the two conductors to its $\pm V_{(BO)}$ value. If the equipment being protected has all its vulnerable components connected between the conductors and ground, then protector Th1 is not required.

impulse testing

To verify the withstand capability and safety of the equipment, standards require that the equipment is tested with various impulse wave forms. The table below shows some common values.

STANDARD	PEAK VOLTAGE SETTING V	VOLTAGE WAVE FORM μ s	PEAK CURRENT VALUE A	CURRENT WAVE FORM μ s	TISP4xxxM3 25 °C RATING A	SERIES RESISTANCE Ω
GR-1089-CORE	2500	2/10	500	2/10	300	11
	1000	10/1000	100	10/1000	50	
FCC Part 68 (March 1998)	1500	10/160	200	10/160	120	2x5.6
	800	10/560	100	10/560	75	3
	1500	9/720 †	37.5	5/320 †	100	0
	1000	9/720 †	25	5/320 †	100	0
I3124	1500	0.5/700	37.5	0.2/310	100	0
ITU-T K.20/K.21	1500	10/700	37.5	5/310	100	0
	4000		100			

† FCC Part 68 terminology for the waveforms produced by the ITU-T recommendation K.21 10/700 impulse generator

If the impulse generator current exceeds the protectors current rating then a series resistance can be used to reduce the current to the protectors rated value and so prevent possible failure. The required value of series resistance for a given waveform is given by the following calculations. First, the minimum total circuit impedance is found by dividing the impulse generators peak voltage by the protectors rated current. The impulse generators fictive impedance (generators peak voltage divided by peak short circuit current) is then subtracted from the minimum total circuit impedance to give the required value of series resistance.

For the FCC Part 68 10/560 waveform the following values result. The minimum total circuit impedance is $800/75 = 10.7 \Omega$ and the generators fictive impedance is $800/100 = 8 \Omega$. This gives a minimum series resistance value of $10.7 - 8 = 2.7 \Omega$. After allowing for tolerance, a $3 \Omega \pm 10\%$ resistor would be suitable. The 10/160 waveform needs a standard resistor value of 5.6Ω per conductor. These would be R1a and R1b in

TISP4070M3BJ THRU TISP4115M3BJ, TISP4125M3BJ THRU TISP4220M3BJ, TISP4240M3BJ THRU TISP4400M3BJ BIDIRECTIONAL THYRISTOR OVERVOLTAGE PROTECTORS

NOVEMBER 1997 - REVISED OCTOBER 2000

Figure 15 and Figure 16. FCC Part 68 allows the equipment to be non-operational after the 10/160 (conductor to ground) and 10/560 (inter-conductor) impulses. The series resistor value may be reduced to zero to pass FCC Part 68 in a non-operational mode e.g. Figure 14. In some cases the equipment will require verification over a temperature range. By using the rated waveform values from Figure 11, the appropriate series resistor value can be calculated for ambient temperatures in the range of -40 °C to 85 °C.

a.c. power testing

The protector can withstand currents applied for times not exceeding those shown in Figure 8. Currents that exceed these times must be terminated or reduced to avoid protector failure. Fuses, PTC (Positive Temperature Coefficient) resistors and fusible resistors are overcurrent protection devices which can be used to reduce the current flow. Protective fuses may range from a few hundred milliamperes to one ampere. In some cases it may be necessary to add some extra series resistance to prevent the fuse opening during impulse testing. The current versus time characteristic of the overcurrent protector must be below the line shown in Figure 8. In some cases there may be a further time limit imposed by the test standard (e.g. UL 1459 wiring simulator failure).

capacitance

The protector characteristic off-state capacitance values are given for d.c. bias voltage, V_D , values of 0, -1 V, -2 V and -50 V. Where possible values are also given for -100 V. Values for other voltages may be calculated by multiplying the $V_D = 0$ capacitance value by the factor given in Figure 6. Up to 10 MHz the capacitance is essentially independent of frequency. Above 10 MHz the effective capacitance is strongly dependent on connection inductance. In many applications, such as Figure 15 and Figure 17, the typical conductor bias voltages will be about -2 V and -50 V. Figure 7 shows the differential (line unbalance) capacitance caused by biasing one protector at -2 V and the other at -50 V.

normal system voltage levels

The protector should not clip or limit the voltages that occur in normal system operation. For unusual conditions, such as ringing without the line connected, some degree of clipping is permissible. Under this condition about 10 V of clipping is normally possible without activating the ring trip circuit.

Figure 10 allows the calculation of the protector V_{DRM} value at temperatures below 25 °C. The calculated value should not be less than the maximum normal system voltages. The TISP4265M3BJ, with a V_{DRM} of 200 V, can be used for the protection of ring generators producing 100 V rms of ring on a battery voltage of -58 V (Th2 and Th3 in Figure 17). The peak ring voltage will be $58 + 1.414 \times 100 = 199.4$ V. However, this is the open circuit voltage and the connection of the line and its equipment will reduce the peak voltage. In the extreme case of an unconnected line, clipping the peak voltage to 190 V should not activate the ring trip. This level of clipping would occur at the temperature when the V_{DRM} has reduced to $190/200 = 0.95$ of its 25 °C value. Figure 10 shows that this condition will occur at an ambient temperature of -28 °C. In this example, the TISP4265M3BJ will allow normal equipment operation provided that the minimum expected ambient temperature does not fall below -28 °C.

JESD51 thermal measurement method

To standardise thermal measurements, the EIA (Electronic Industries Alliance) has created the JESD51 standard. Part 2 of the standard (JESD51-2, 1995) describes the test environment. This is a 0.0283 m^3 (1 ft^3) cube which contains the test PCB (Printed Circuit Board) horizontally mounted at the centre. Part 3 of the standard (JESD51-3, 1996) defines two test PCBs for surface mount components; one for packages smaller than 27 mm on a side and the other for packages up to 48 mm. The SMBJ measurements used the smaller 76.2 mm x 114.3 mm (3.0 " x 4.5 ") PCB. The JESD51-3 PCBs are designed to have low effective thermal conductivity (high thermal resistance) and represent a worse case condition. The PCBs used in the majority of applications will achieve lower values of thermal resistance and so can dissipate higher power levels than indicated by the JESD51 values.

PRODUCT INFORMATION

TISP4070M3BJ THRU TISP4115M3BJ, TISP4125M3BJ THRU TISP4220M3BJ,
TISP4240M3BJ THRU TISP4400M3BJ
BIDIRECTIONAL THYRISTOR OVERVOLTAGE PROTECTORS

NOVEMBER 1997 - REVISED OCTOBER 2000

typical circuits

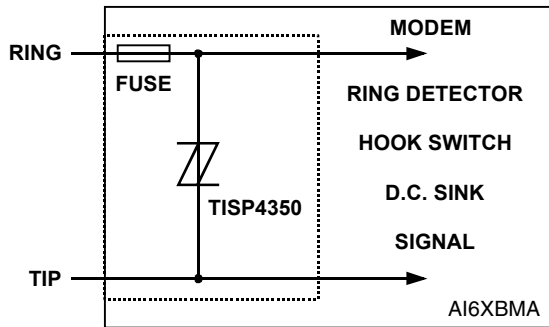

Figure 14. MODEM INTER-WIRE PROTECTION

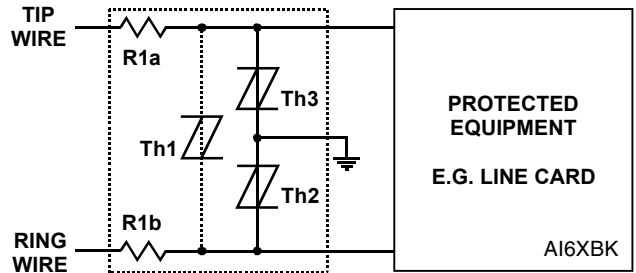

Figure 15. PROTECTION MODULE

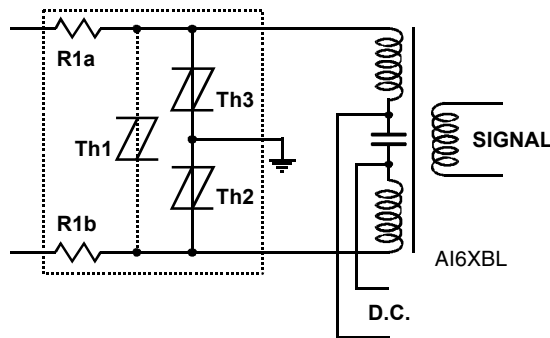

Figure 16. ISDN PROTECTION

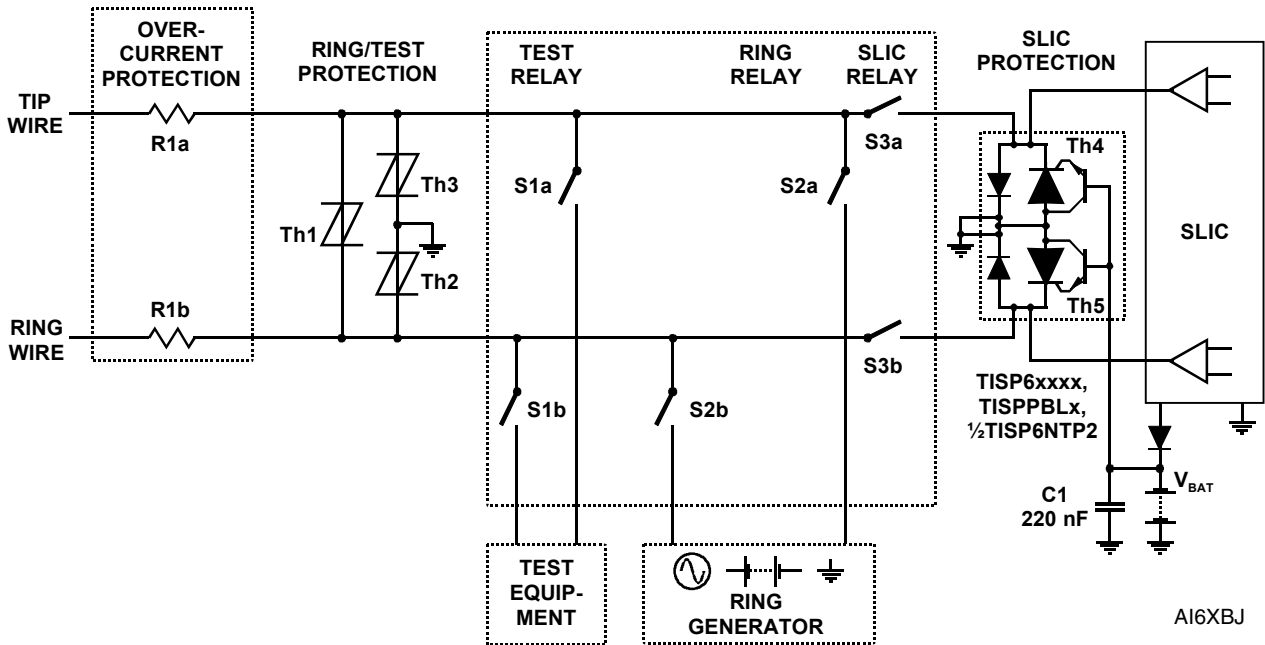

Figure 17. LINE CARD RING/TEST PROTECTION

PRODUCT INFORMATION



**TISP4070M3BJ THRU TISP4115M3BJ, TISP4125M3BJ THRU TISP4220M3BJ,
TISP4240M3BJ THRU TISP4400M3BJ
BIDIRECTIONAL THYRISTOR OVERVOLTAGE PROTECTORS**

NOVEMBER 1997 - REVISED OCTOBER 2000

MECHANICAL DATA

SMBJ (DO-214AA)

plastic surface mount diode package

This surface mount package consists of a circuit mounted on a lead frame and encapsulated within a plastic compound. The compound will withstand soldering temperature with no deformation, and circuit performance characteristics will remain stable when operated in high humidity conditions. Leads require no additional cleaning or processing when used in soldered assembly.

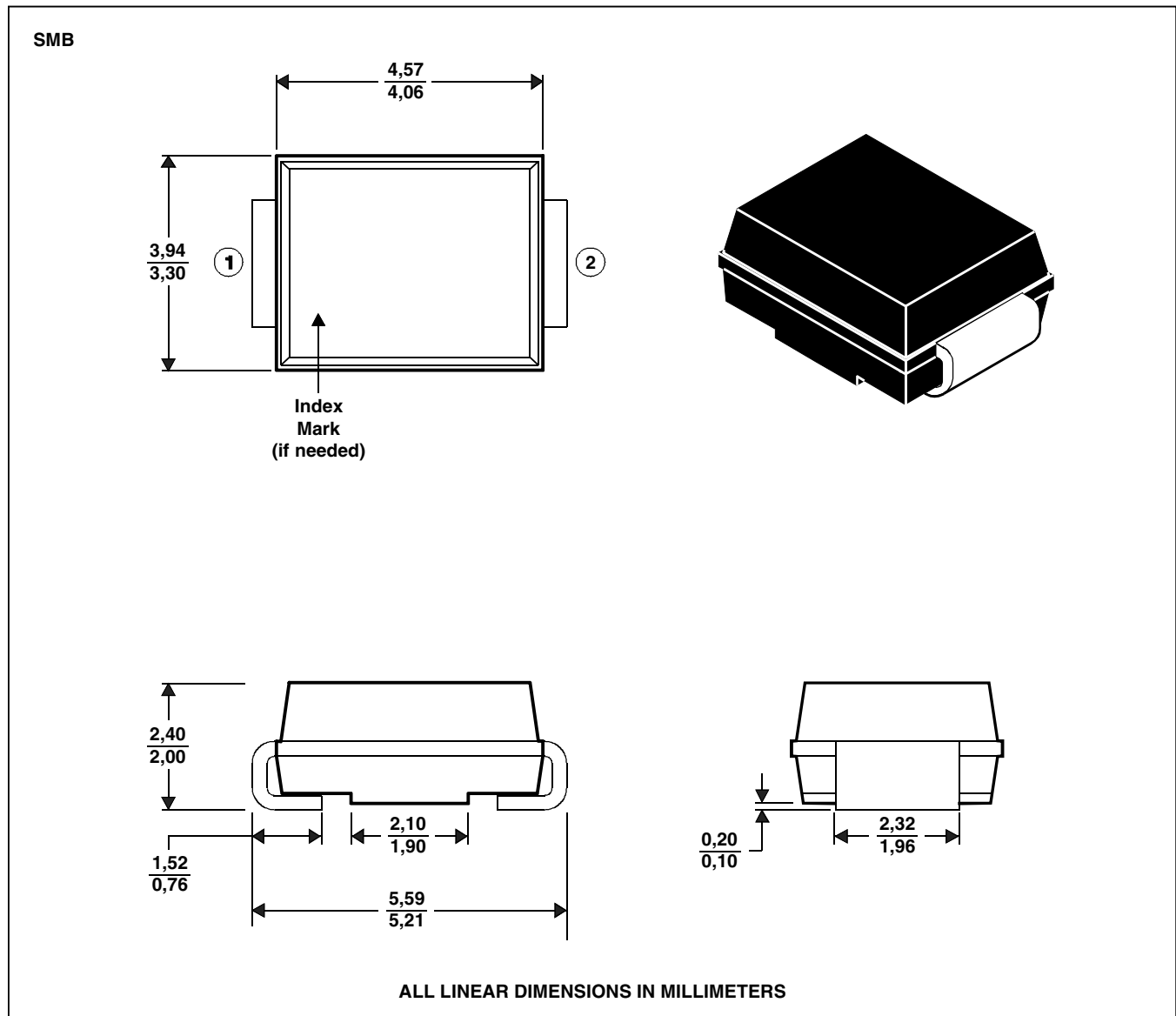

MDXXBHA

PRODUCT INFORMATION

**TISP4070M3BJ THRU TISP4115M3BJ, TISP4125M3BJ THRU TISP4220M3BJ,
TISP4240M3BJ THRU TISP4400M3BJ
BIDIRECTIONAL THYRISTOR OVERVOLTAGE PROTECTORS**

NOVEMBER 1997 - REVISED OCTOBER 2000

MECHANICAL DATA

recommended printed wiring footprint.

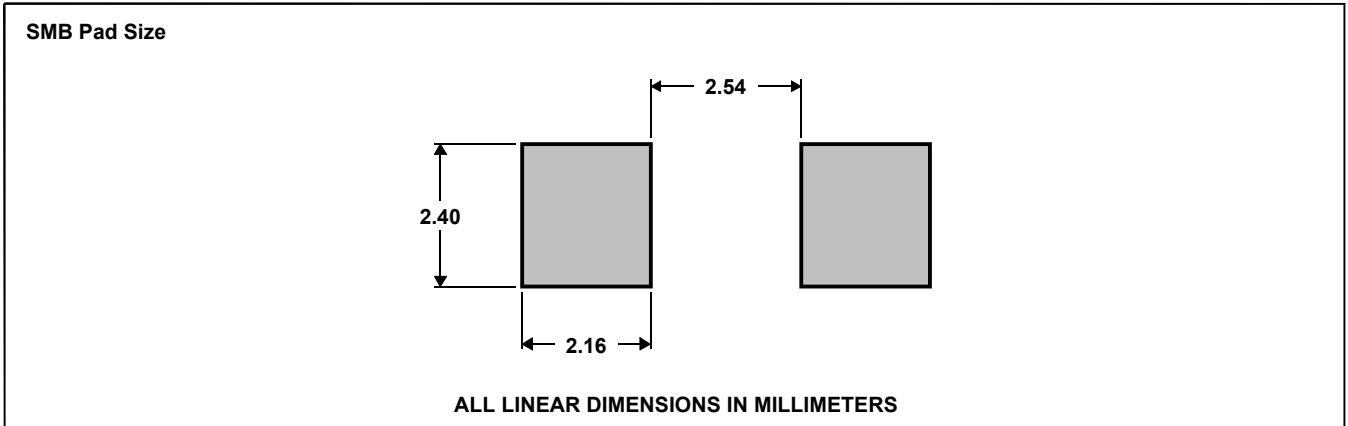

MDXXBI

device symbolization code

Devices will be coded as below As the device parameters are symmetrical, terminal 1 is not identified.

DEVICE	SYMBOLIZATION CODE
TISP4070M3BJ	4070M3
TISP4080M3BJ	4080M3
TISP4095M3BJ	4095M3
TISP4115M3BJ	4115M3
TISP4125M3BJ	4125M3
TISP4145M3BJ	4145M3
TISP4165M3BJ	4165M3
TISP4180M3BJ	4180M3
TISP4200M3BJ	4200M3
TISP4220M3BJ	4220M3
TISP4240M3BJ	4240M3
TISP4250M3BJ	4250M3
TISP4265M3BJ	4265M3
TISP4290M3BJ	4290M3
TISP4300M3BJ	4300M3
TISP4350M3BJ	4350M3
TISP4395M3BJ	4395M3
TISP4400M3BJ	4400M3

carrier information

Devices are shipped in one of the carriers below. Unless a specific method of shipment is specified by the customer, devices will be shipped in the most practical carrier. For production quantities the carrier will be embossed tape reel pack. Evaluation quantities may be shipped in bulk pack or embossed tape.

CARRIER	ORDER #
Embossed Tape Reel Pack	TISP4xxxM3BJR
Bulk Pack	TISP4xxxM3BJ

PRODUCT INFORMATION



**TISP4070M3BJ THRU TISP4115M3BJ, TISP4125M3BJ THRU TISP4220M3BJ,
TISP4240M3BJ THRU TISP4400M3BJ
BIDIRECTIONAL THYRISTOR OVERVOLTAGE PROTECTORS**

NOVEMBER 1997 - REVISED OCTOBER 2000

MECHANICAL DATA

tape dimensions

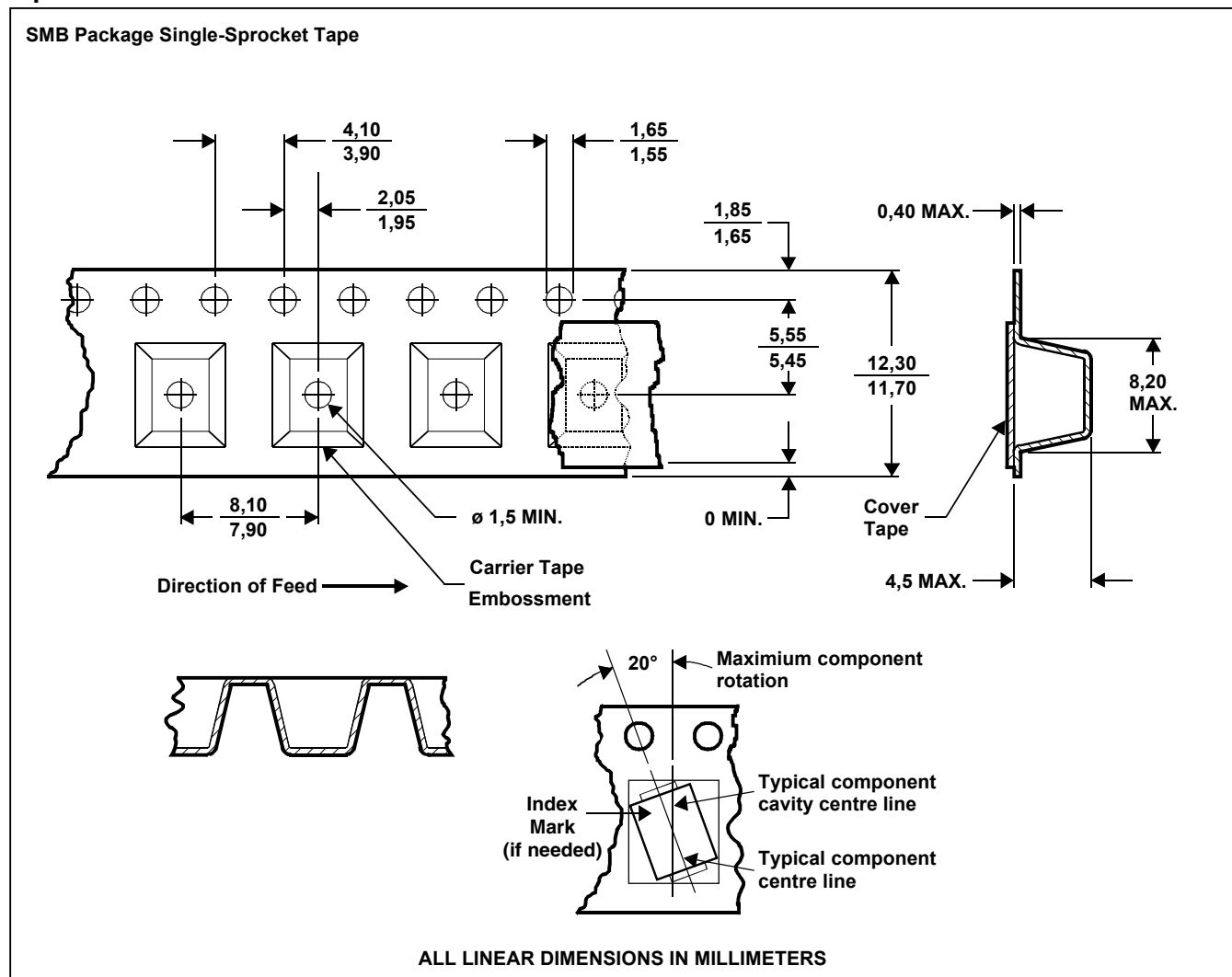

NOTES: A. The clearance between the component and the cavity must be within 0,05 mm MIN. to 0,65 mm MAX. so that the component cannot rotate more than 20° within the determined cavity. MDXXBJ

B. Taped devices are supplied on a reel of the following dimensions:-

Reel diameter: 330 ±3,0 mm
Reel hub diameter: 75 mm MIN.
Reel axial hole: 13,0 ±0,5 mm

C. 3000 devices are on a reel.

PRODUCT INFORMATION

**TISP4070M3BJ THRU TISP4115M3BJ, TISP4125M3BJ THRU TISP4220M3BJ,
TISP4240M3BJ THRU TISP4400M3BJ
BIDIRECTIONAL THYRISTOR OVERVOLTAGE PROTECTORS**

NOVEMBER 1997 - REVISED OCTOBER 2000

IMPORTANT NOTICE

Power Innovations Limited (PI) reserves the right to make changes to its products or to discontinue any semiconductor product or service without notice, and advises its customers to verify, before placing orders, that the information being relied on is current.

PI warrants performance of its semiconductor products to the specifications applicable at the time of sale in accordance with PI's standard warranty. Testing and other quality control techniques are utilized to the extent PI deems necessary to support this warranty. Specific testing of all parameters of each device is not necessarily performed, except those mandated by government requirements.

PI assumes no liability for applications assistance, customer product design, software performance, or infringement of patents or services described herein. Nor is any license, either express or implied, granted under any patent right, copyright, design right, or other intellectual property right of PI covering or relating to any combination, machine, or process in which such semiconductor products or services might be or are used.

PI SEMICONDUCTOR PRODUCTS ARE NOT DESIGNED, INTENDED, AUTHORISED, OR WARRANTED TO BE SUITABLE FOR USE IN LIFE-SUPPORT APPLICATIONS, DEVICES OR SYSTEMS.

Copyright © 2000, Power Innovations Limited

PRODUCT INFORMATION

