

30 WATT REGULATED, 2:1 WIDE INPUT RANGE, HIGH DENSITY DC/DC CONVERTER



WP30R



APPLICATIONS

- TELECOMMUNICATION APPLICATIONS
- BATTERY POWERED SYSTEMS
- PROCESS CONTROL EQUIPMENT
- TRANSPORTATION EQUIPMENT
- DISTRIBUTED POWER SYSTEMS

DESCRIPTION

The WP30R Series is a family of high performance DC/DC converters. The unit is housed in a space-saving shell and combines low cost with high performance across all line and load conditions. A $\pm 10\%$ output trim feature is provided, allowing the user to compensate for long line lengths. The WP30R Series is assembled by a fully automated process using surface mount components for increased reliability. The converter's rugged, low-profile, aluminium housing provides excellent EMI/RFI shielding. Other features include:

- Full Regulation Down to Zero Load
- Under Voltage Lock-Out, Auto-Start
- Internal Temperature Shutdown, Auto-Reset
- Soft Start
- Remote On/Off (Available in Positive or Negative Logic)
- Remote Sense (Available in Single Outputs)
- Over Current Protection
- Output Over Voltage Protection
- Output Voltage Adjust

FEATURES

- 9-18 VDC & 36-75 VDC INPUT RANGES
- INDUSTRY STANDARD PINOUTS
- INPUT AND OUTPUT FILTERING
- SINGLE AND TRIPLE OUTPUTS
- EXTENDED TEMPERATURE RANGE:
-40°C TO +100°C BASEPLATE TEMPERATURE
- REMOTE ON/OFF FUNCTION
- INPUT REVERSE VOLTAGE PROTECTION
- FIXED FREQUENCY OPERATION
- EXCELLENT CROSS-REGULATION
- SIX-SIDED SHIELDING
- SHORT CIRCUIT PROTECTION
- EN60950, UL 1950 SAFETY APPROVALS PENDING
- EMC EN55022 LEVEL A

The data sheet contains preliminary data. C&D TECHNOLOGIES reserves the right to make changes to the specifications without notice. Please contact C&D TECHNOLOGIES for latest available information.

AGENCY APPROVALS PENDING



Internet: <http://www.cdpowerelectronics.com>

Power Electronics Division, United States
3400 E Britannia Drive, Tucson, Arizona 85706
Phone: 800.527.2537 Fax: 520.770.9369

Power Electronics Division, Europe
C&D Technologies (Power Electronics) Ltd.
132 Shannon Industrial Estate, Shannon, Co. Clare, Ireland
Tel: +353.61.474.133 Fax: +353.61.474.141

ELECTRICAL SPECIFICATIONS

Specifications typical at $T_A=25^{\circ}\text{C}$, nominal input voltage, rated output current unless otherwise stated.

MODEL	NOMINAL INPUT VOLTAGE (V _{Dc})	RATED OUTPUT VOLTAGE (V _{Dc})	OUTPUT CURRENT			INPUT CURRENT NOM LOAD (A)	EFFICIENCY (%)
			MIN LOAD (A)	NOM LOAD (A)	MAX LOAD (A)		
WP30R24S03	24	3.3	0.0	9.0	11.0	1.488	84
WP30R24S05	24	5.0	0.0	6.0	7.2	1.488	84
WP30R24S12	24	12	0.0	2.5	3.0	1.47	85
WP30R24S15	24	15	0.0	2.0	2.4	1.47	85
WP30R24T312	24	3.3 ± 12	0.0	6.0 ± 0.417	7.5 ± 0.521	1.506	83
WP30R24T315	24	3.3 ± 15	0.0	6.0 ± 0.333	7.5 ± 0.416	1.506	83
WP30R24T512	24	5 ± 12	0.0	4.0 ± 0.417	5.0 ± 0.521	1.488	84
WP30R24T515	24	5 ± 15	0.0	4.0 ± 0.333	5.0 ± 0.416	1.488	84
WP30R48S03	48	3.3	0.0	9.0	11.0	0.727	86
WP30R48S05	48	5.1	0.0	6.0	7.5	0.727	86
WP30R48S12	48	12	0.0	2.5	3.0	0.718	87
WP30R48S15	48	15	0.0	2.0	2.4	0.718	87
WP30R48T312	48	3.3 ± 12	0.0	6.0 ± 0.417	7.5 ± 0.521	0.735	85
WP30R48T315	48	3.3 ± 15	0.0	6.0 ± 0.333	7.5 ± 0.416	0.735	85
WP30R48T512	48	5 ± 12	0.0	4.0 ± 0.417	5.0 ± 0.521	0.735	85
WP30R48T515	48	5 ± 15	0.0	4.0 ± 0.333	5.0 ± 0.416	0.735	85

COMMON SPECIFICATIONS

Specifications typical at $T_A=25^{\circ}\text{C}$, nominal input voltage, rated output current unless otherwise stated.

PARAMETER	CONDITIONS	MIN	TYP	MAX	UNITS
INPUT					
Voltage Range	WP30R24xyyz WP30R48xyyz	18 36	24 48 50	36 75 75	V _{Dc} V _{Dc} mA
Reflected Ripple Current					
INPUT CONTROL					
Temperature Shutdown			107		°C
Temperature Hysteresis			5		°C
Quiescent Standby Current	Current into & Vin		8	10	mA
Under Voltage Shutdown	WP30R24xyyz		16.5		V
	WP30R48xyyz		32.5		V
Under Voltage Hysteresis	WP30R24xyyz		1		V
	WP30R48xyyz		1		V
ISOLATION					
Rated Voltage		1500			V _{Dc}
Test Voltage	60 Hz, 10 Seconds	1500			V _{pk}
Resistance			10		GΩ
Capacitance			1000		pF
Leakage Current	V _{ISO} =240V _{AC} 60 Hz			100	nArms
OUTPUT					
Rated Power				30	W
Voltage Setpoint Accuracy					
Single & Main Outputs				±1.5	%
Aux. Outputs, Triples				±3.0	%
Temperature Coefficient			±0.2		%/°C
Line Regulation	High Line to Low Line				
Single & Main Outputs				±0.1	%
Aux. Outputs, Triples				±0.7	%
Load Regulation	Min. Load to Nom Load				
Single & Main Outputs				±0.4	%
Aux. Outputs, Triples				±0.6	%
Ripple & Noise					
Single & Main Outputs	BW = 5Hz to 20 MHz		50	80	mVp-p
Aux. Outputs, Triples	BW = 5Hz to 20 MHz		80	120	mVp-p
Output Adjust Range	All Outputs		±10	±12	%
Output Adjust Current	Current Sourced/Sank by Vadj Pin			±0.5	mA
Short Circuit Protection					
Single & Main Output				7.5	A
Aux. Outputs, 10 Seconds		±8			
GENERAL					
Switching Frequency			250		kHz
MTTF per MIL-HDBK-217	Circuit Stress Method				
Ground Benign	TA = +25°C, Unmodified Database		1,500,000		Hr
Package Weight			85		g
TEMPERATURE					
Operation/Specification	Case Temperature	-40		+100	°C
Storage	Case Temperature	-55		+110	°C
Shutdown Temperature	Case Temperature	+105		+110	°C
Thermal Impedance, case-ambient			7		°C/W

ORDERING INFORMATION

WP30R **xyzz** -

Device Family _____
 Indicated 30 Watt Regulated DC/DC Converter

Model Number _____
 Selected from Table of Electrical Characteristics
 Where:
 xx = Input Voltage
 y = Number of Outputs (Single "S", Triple "T")
 zz = Output Voltage

Shell Connection _____
 (C,F,M,N,P) refer to NOTES.

Remote On/Off Logic _____
 Positive Logic - No Number
 Negative Logic - 1

NOTES: A "C" designator indicates the aluminum shell is connected internally to the common output return pin.

An "F" designator indicates the aluminum shell is floating and is not connected to any part of the converter circuitry.

An "M" designator indicates the aluminum shell is connected internally to the main output return pin.

An "N" designator indicates the aluminum shell is connected internally to the negative input voltage pin.

A "P" designator indicates the aluminum shell is connected internally to the positive input voltage pin.

MECHANICAL

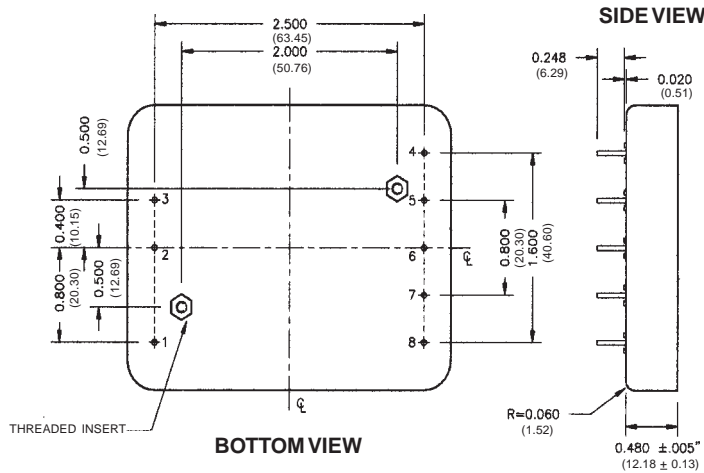
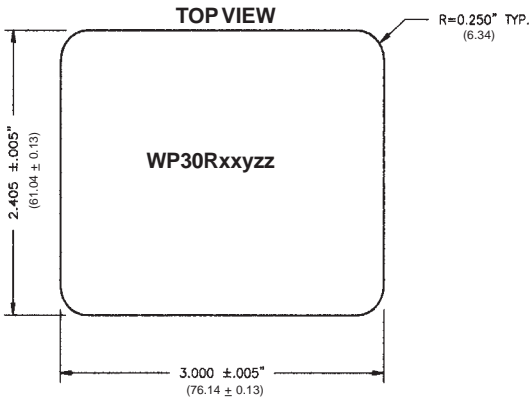

PIN CONNECTIONS		
PIN #	SINGLE	TRIPLE
1	Remote On/Off	Remote On/Off
2	+Vin	+Vin
3	-Vin	-Vin
4	-Sense	-Aux
5	+Sense	+Aux
6	Com	Com
7	+Vout	+Vout
8	Adj	Adj

NOTES:
 All dimensions are in inches (millimeters).

Pin placement tolerance: $\pm 0.015"$ ($\pm 0.2\text{mm}$)

Threaded insert (hex) for fixing to PCB.

Marked with specific model ordered, date, code, job code.

MATERIAL: Units are enclosed in an aluminum case. Lead material is brass with a solder plated surface to allow ease of solderability.

The information provided herein is believed to be reliable; however, C&D TECHNOLOGIES assumes no responsibility for inaccuracies or omissions. C&D TECHNOLOGIES assumes no responsibility for the use of this information, and all use of such information shall be entirely at the user's own risk. Prices and specifications are subject to change without notice. No patent rights or licenses to any of the circuits described herein are implied or granted to any third party. C&D TECHNOLOGIES does not authorize or warrant any C&D TECHNOLOGIES product for use in life support devices/systems or in aircraft control applications.

PERFORMANCE GRAPHS

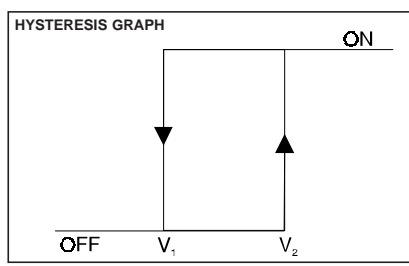
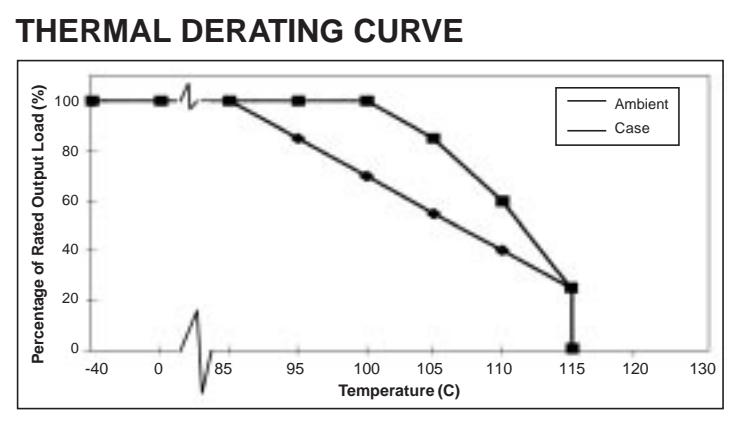
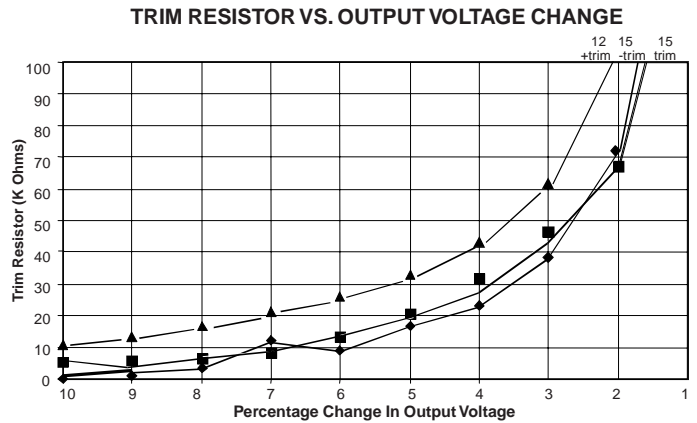
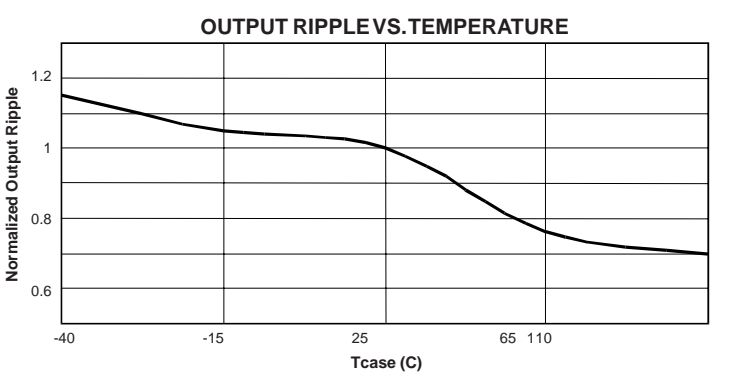
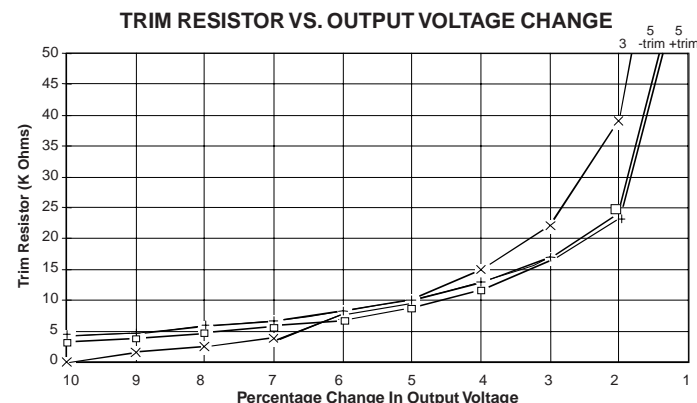
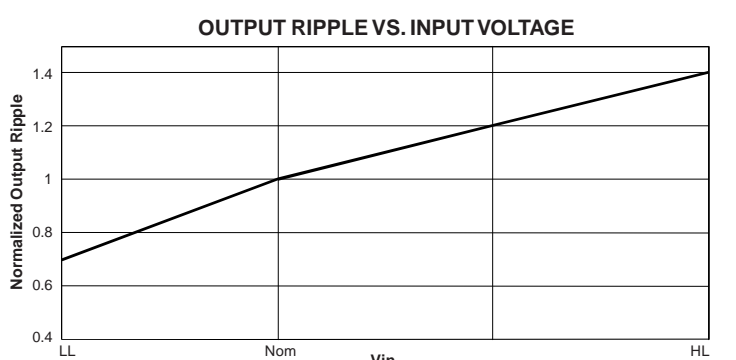
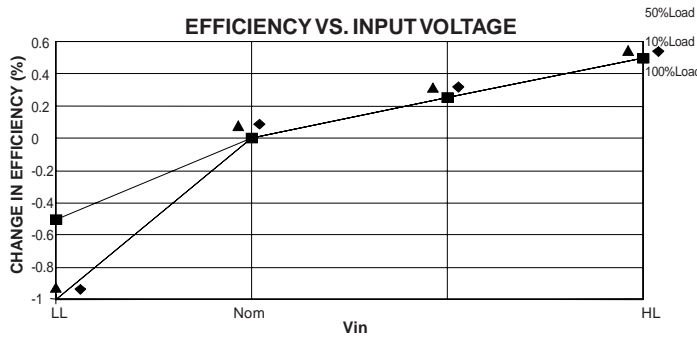
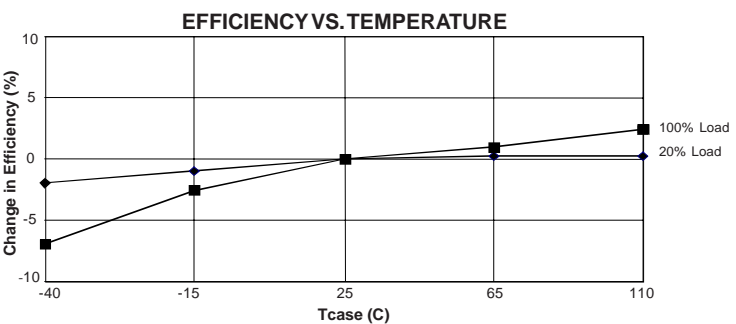
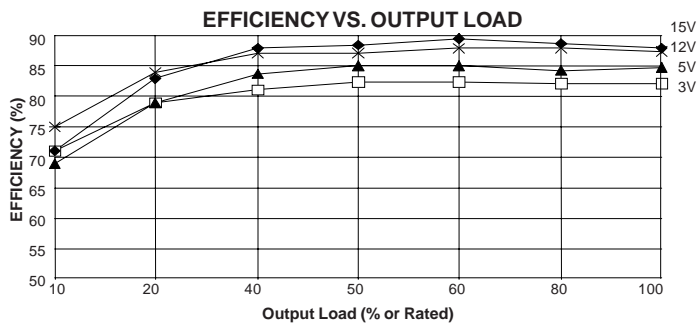

Undervoltage Lockout Threshold Voltages

Nominal Input Voltage Range	Shutdown Low Voltage (V1) OFF	Shutdown High Voltage (V2) ON
24	16.5	17.5
48	32.5	33.5

Specifications typical at TA=25°C, rated output current.