

4 Channel Rail to Rail Output Operating Amplifier

Features

- **Operating Voltage: VDD : 2.4V~6.0V**
- **Low Input Current**
- **Rail to Rail Output Swing**
- **Push-Pull Output Driving**
- **High Output Current Drive :100mA**
- **Wide Bandwidth: 7MHz**
- **Fast Slew Rate 5V/ms**
- **Available in 14 pin TSSOP Package**
- **Lead Free and Green Devices Available**
(RoHS Compliant)

Applications

- **Amplifiers**
- **Filters**
- **Analog circuit**

General Description

The APC209 consists of four independent, high gain and high output driver current, CMOS operating amplifier, combining rail to rail output range with large output current. It provides a low input bias current 2pA. The output swing of the amplifier, guaranteed for loads down to 1kΩ and output current to an 10Ω load from a 5V power supply. APC209 is designed to operate at 3V, especially well-suited for low voltage application.

Simplified Application Circuit

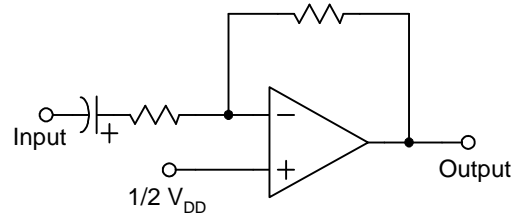

Ordering and Marking Information

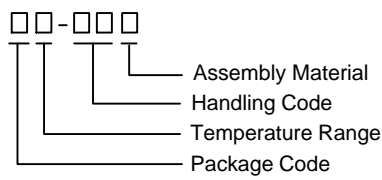
APC209		Package Code O : TSSOP-14 Operating Ambient Temperature Range I : -40 to 85 °C Handling Code TR : Tape & Reel Assembly Material G : Halogen and Lead Free Device
APC209 O :	<div style="border: 1px solid black; padding: 2px; display: inline-block;"> APC209 XXXXX </div>	XXXXX - Date Code

Note : ANPEC lead-free products contain molding compounds/die attach materials and 100% matte tin plate termination finish; which are fully compliant with RoHS. ANPEC lead-free products meet or exceed the lead-free requirements of IPC/JEDEC J-STD-020D for MSL classification at lead-free peak reflow temperature. ANPEC defines "Green" to mean lead-free (RoHS compliant) and halogen free (Br or Cl does not exceed 900ppm by weight in homogeneous material and total of Br and Cl does not exceed 1500ppm by weight).

ANPEC reserves the right to make changes to improve reliability or manufacturability without notice, and advise customers to obtain the latest version of relevant information to verify before placing orders.

Pin Configuration

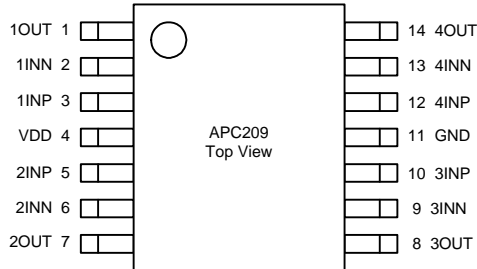

Absolute Maximum Ratings (Note 1)

Symbol	Parameter	Rating	Unit
V_{DD}	Supply Voltage (VDD to GND)	-0.3 ~ 6	V
	Input Voltage (INN,INP to GND)	-0.3 ~ $V_{DD}+0.3$	V
P_D	Power Dissipation	Internally Limited	W
T_J	Maximum Junction Temperature	150	°C
T_{STG}	Storage Temperature	-65 ~ 150	°C
T_{SDR}	Maximum Lead Soldering Temperature, 10 Seconds	260	°C

Note 1 : Absolute Maximum Ratings are those values beyond which the life of a device may be impaired. Exposure to absolute maximum rating conditions for extended periods may affect device reliability.

Thermal Characteristics

Symbol	Parameter	Typical Value	Unit
θ_{JA}	Junction-to-Ambient Resistance in Free Air ^(Note 2) TSSOP-14	100	°C/W

Note 2 : θ_{JA} is measured with the component mounted on a high effective thermal conductivity test board in free air.

Recommended Operation Conditions (Note 3)

Symbol	Parameter	Range	Unit
V_{DD}	Supply Voltage	2.4 ~ 5.5	V
V_{ICM}	Common Mode Input Voltage	0 ~ $V_{DD}-1$	V
T_A	Ambient Temperature	-40 ~ 85	°C
T_J	Junction Temperature	-40 ~ 125	°C

Note 3 : Refer to the typical application circuit

Electrical Characteristics

Unless otherwise specified, these specifications apply over $V_{DD}=5V$, $GND=0V$ and $T_A=25\text{ }^\circ\text{C}$, unless otherwise specified.

Symbol	Parameter	Test Conditions	APC209			Unit
			Min	Typ	Max	
V_{OS}	Input Offset Voltage	$T_A=25\text{ }^\circ\text{C}$	-	4	10	mV
		$-25\text{ }^\circ\text{C}<T_A<75\text{ }^\circ\text{C}$				
I_{BIAS}	Input Bias Current		-	2	-	pA
V_{ICM}	Input Command Voltage Range		0	-	$V_{DD}-0.8$	V
R_{IN}	Input Resistance		-	5	-	$M\Omega$
V_O	Output Voltage Swing	$R_L=2k\Omega$	0	-	5	V
V_{OH}	Output High Voltage	$R_L=10k\Omega, -25\text{ }^\circ\text{C}<T_A<75\text{ }^\circ\text{C}$	-	4.98	-	V
V_{OL}	Output Low Voltage	$R_L=10k\Omega, -25\text{ }^\circ\text{C}<T_A<75\text{ }^\circ\text{C}$	-	0.02	-	V
I_{OUT}	Output Source Current	$V_O=4.5V$	-	-300	-	mA
	Output Sink Current	$V_O=0.5V$	-	300	-	
I_{DD}	Supply Current (Per Channel)	$V_O=1/2V_{DD}, -25\text{ }^\circ\text{C}<T_A<75\text{ }^\circ\text{C}$	-	1.25	4	mA
		$2.4V<V_{DD}<6V, T_A=25\text{ }^\circ\text{C}$	-	2.5	5	
CMRR	Common Mode Rejection Ratio	$V_O=4.5V$	-	-80	-	dB
I_{OS}	Input Offset Current	$V_O=0.5V$	-	-	1	pA
PSRR	Supply Voltage Rejection Ratio	$V_{in}=100mV_{PP}, f_{in}=100Hz, R_L=2k\Omega$	-	-50	-	dB
A_V	Large Signal Voltage Gain	$R_L=10k\Omega$	-	85	-	dB
GBW	Gain Bandwidth Product	$R_L=10k\Omega$	-	7	-	MHz
PM	Phase Margin	$A_V=100, R_L=10k\Omega$	-	48	-	Degree
SR	Slew Rate	$V_{OPP}=0.8V, C_L=150pF, R_L=10k\Omega$	-	5.6	-	$V/\mu S$
THD+N	Total Harmonic Distortion Plus Noise	$A_V=1$	-	0.01	-	%

Typical Operating Characteristics

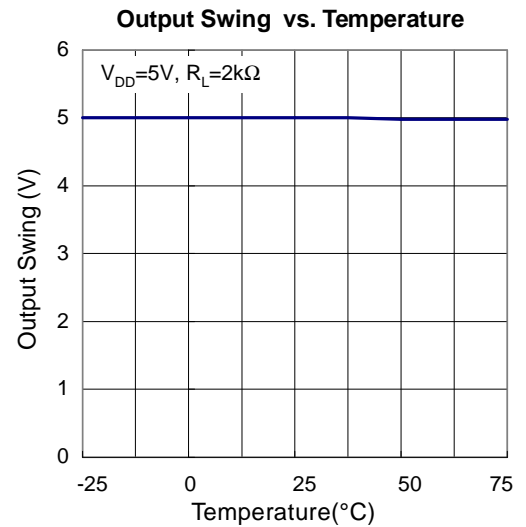
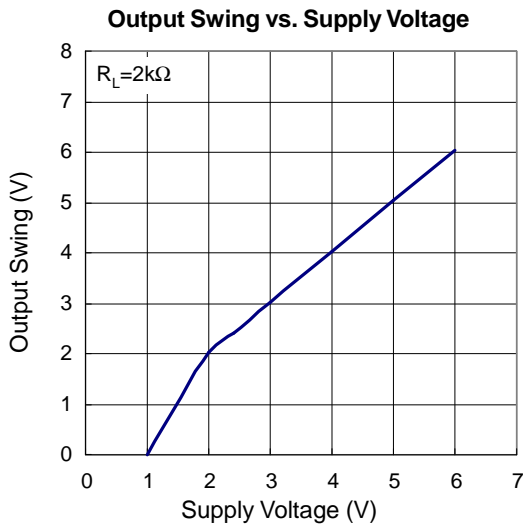
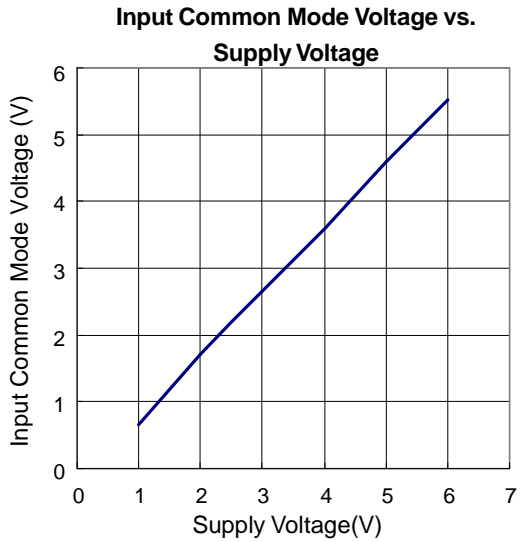
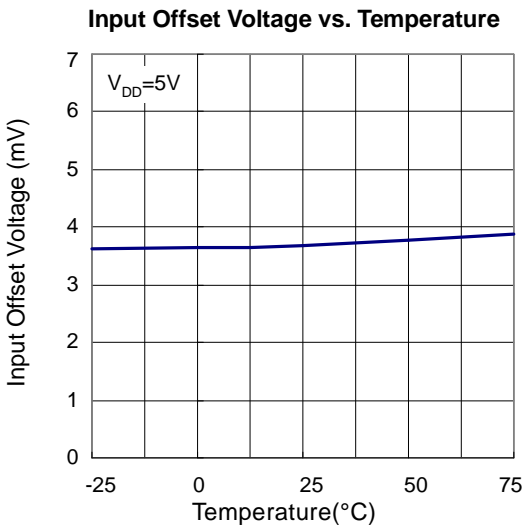
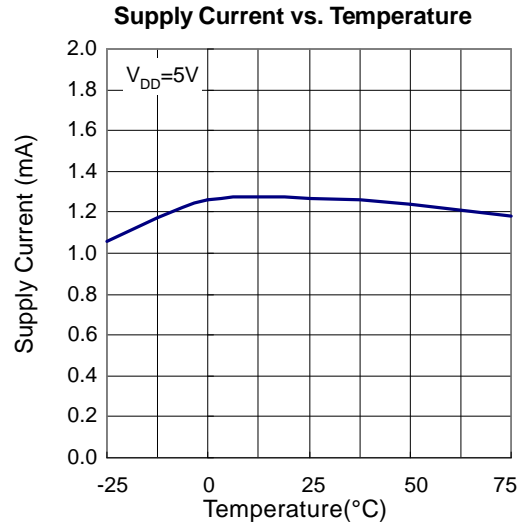
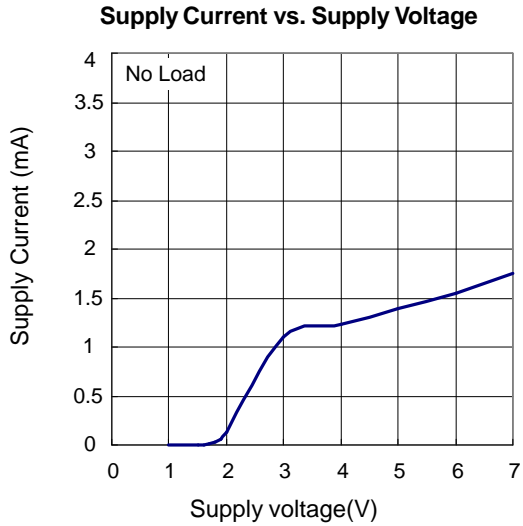

Typical Operating Characteristics (Cont.)

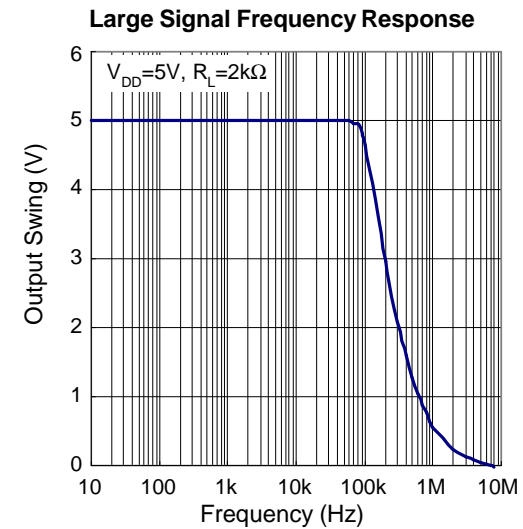
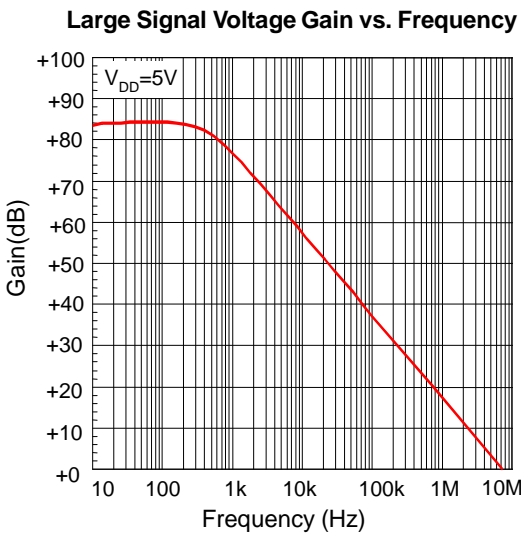
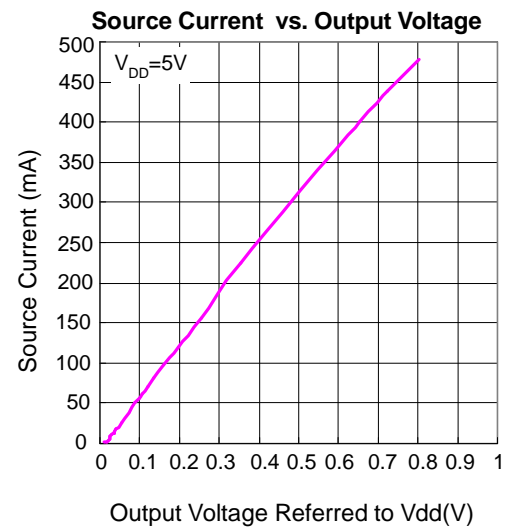
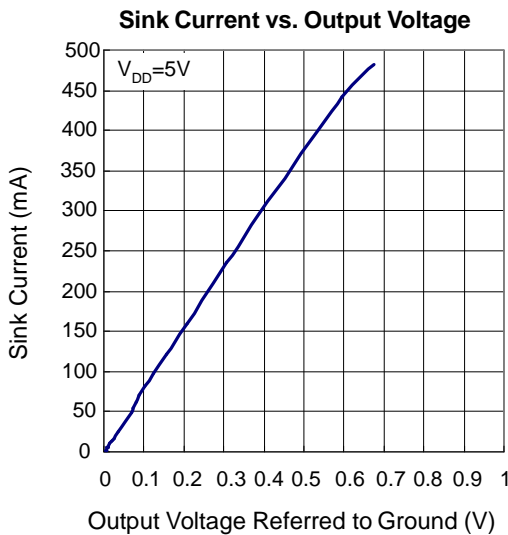
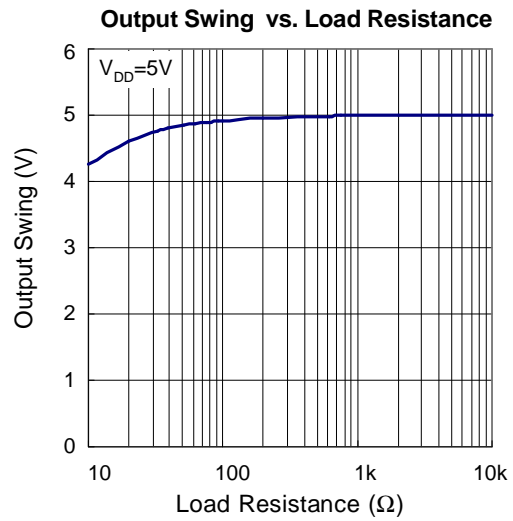
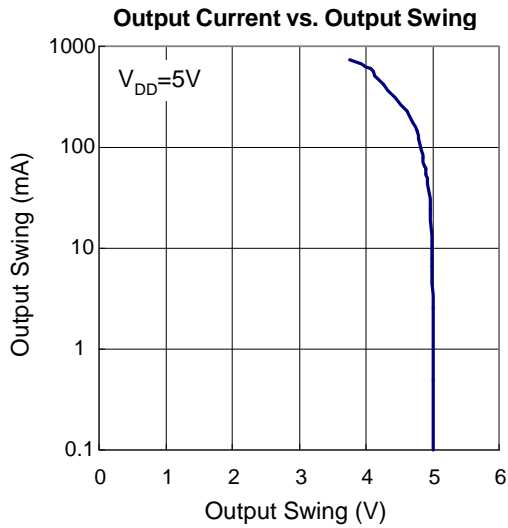

Typical Operating Characteristics (Cont.)

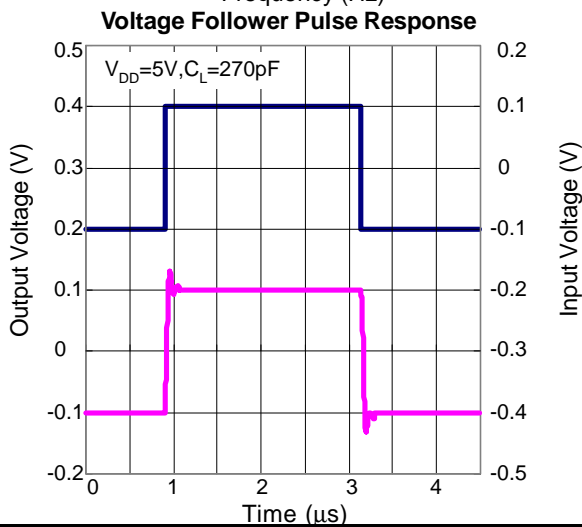
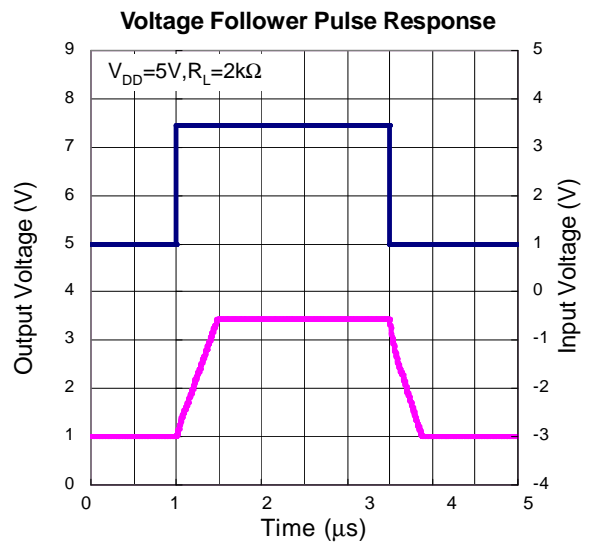
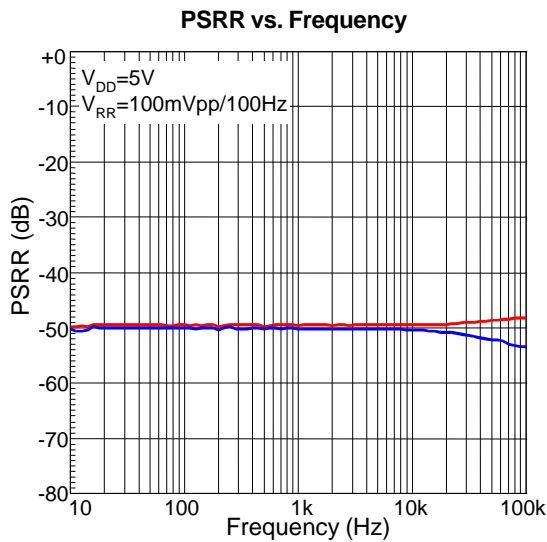
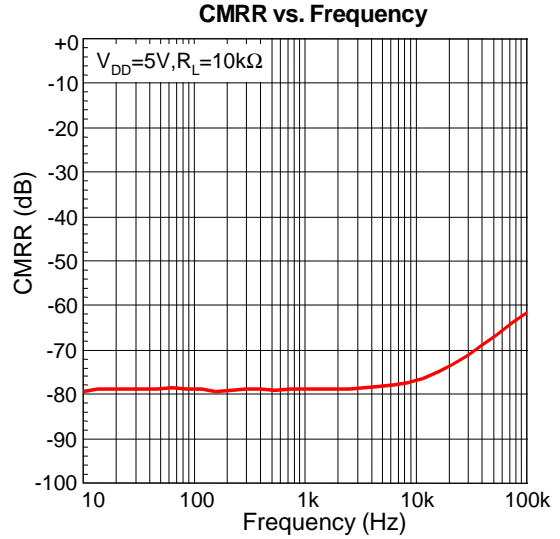
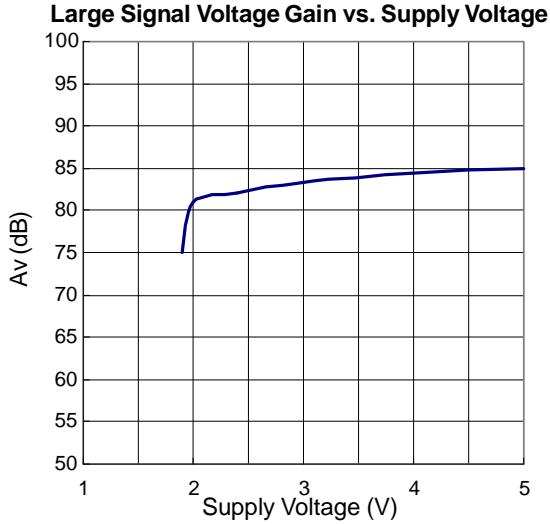

Pin Description

PIN		FUNCTION
NO.	NAME	
1	1OUT	The output pin of 1st operating amplifier.
2	1INN	The inverting input pin of 1st operating amplifier.
3	1INP	The non-inverting input pin of 1st operating amplifier.
4	VDD	Operating Amplifier's supply voltage pin.
5	2INP	The non-inverting input pin of 2nd operating amplifier.
6	2INN	The inverting input pin of 2nd operating amplifier.
7	2OUT	The output pin of 2nd operating amplifier.
8	3OUT	The output pin of 3rd operating amplifier.
9	3INN	The inverting input pin of 3rd operating amplifier.
10	3INP	The non-inverting input pin of 3rd operating amplifier.
11	GND	Operating Amplifier's ground.
12	4INP	The non-inverting input pin of 4th operating amplifier.
13	4INN	The inverting input pin of 4th operating amplifier.
14	4OUT	The output pin of 4th operating amplifier.

Block Diagram

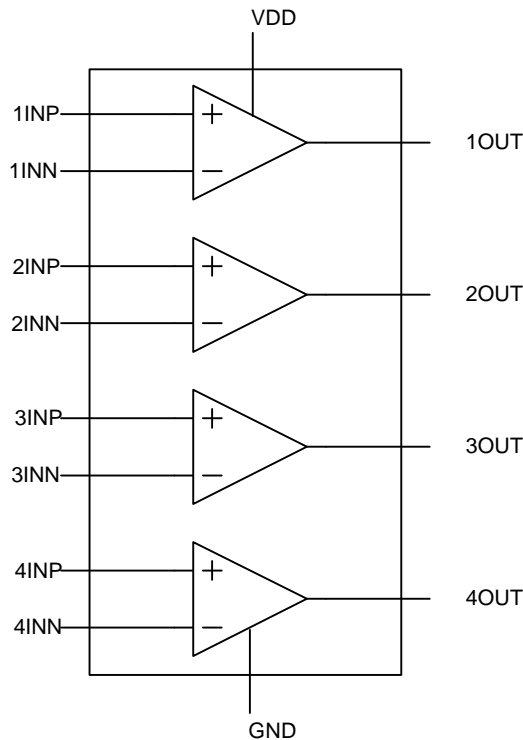

Package Information

TSSOP-14

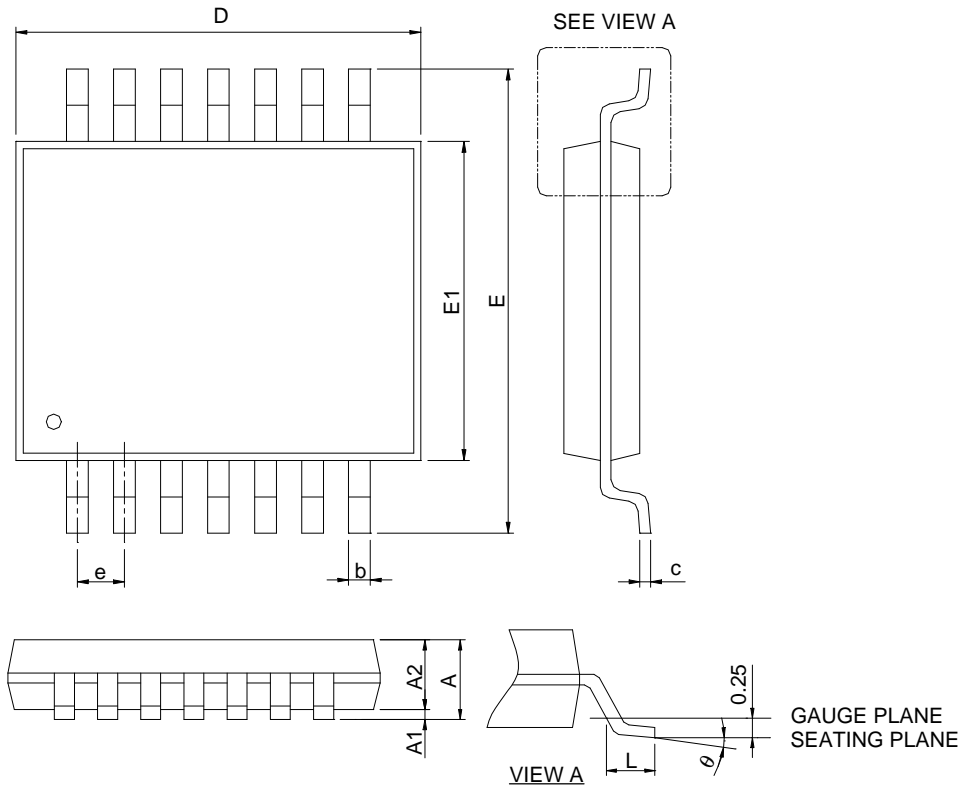

DIMENSIONS	TSSOP-14			
	MILLIMETERS		INCHES	
	MIN.	MAX.	MIN.	MAX.
A		1.20		0.047
A1	0.05	0.15	0.002	0.006
A2	0.80	1.05	0.031	0.041
b	0.19	0.30	0.007	0.012
c	0.09	0.20	0.004	0.008
D	4.90	5.10	0.193	0.201
E	6.20	6.60	0.244	0.260
E1	4.30	4.50	0.169	0.177
e	0.65 BSC		0.026 BSC	
L	0.45	0.75	0.018	0.030
θ	0°	8°	0°	8°

- Note : 1. Followed from JEDEC MO-153 AB-1.
 2. Dimension "D" does not include mold flash, protrusions or gate burrs. Mold flash, protrusion or gate burrs shall not exceed 6 mil per side .
 3. Dimension "E1" does not include inter-lead flash or protrusions. Inter-lead flash and protrusions shall not exceed 10 mil per side.

Carrier Tape & Reel Dimensions

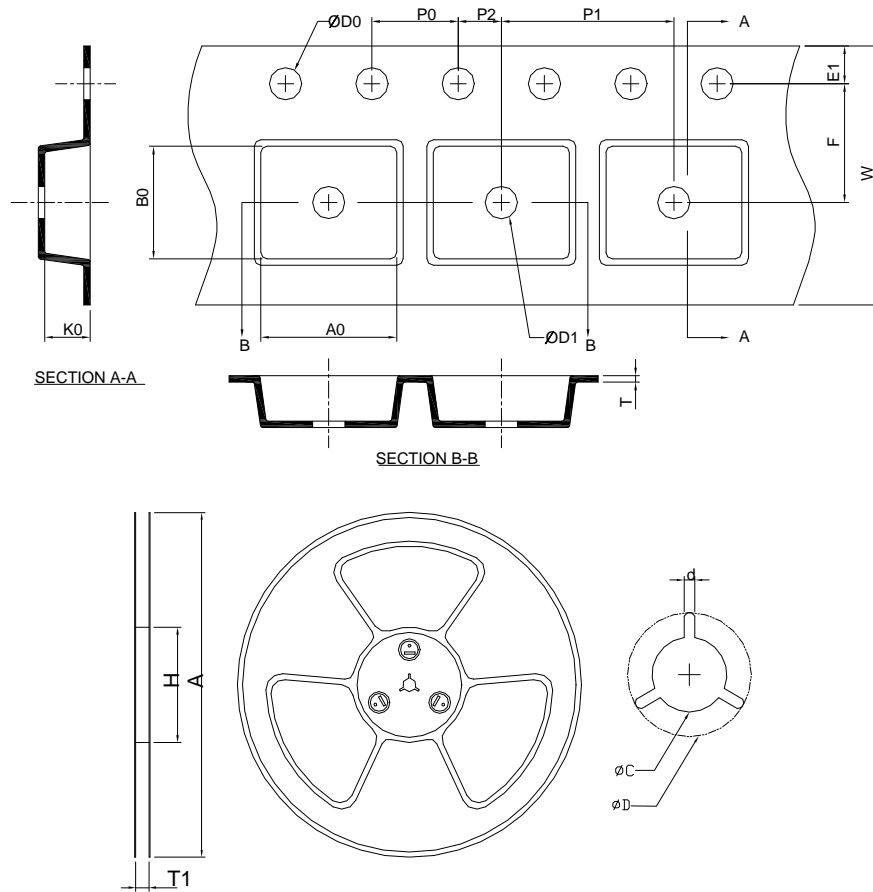

Application	A	H	T1	C	d	D	W	E1	F
TSSOP-14	330.0 ±0.00	50 MIN.	16.4+2.00 -0.00	13.0+0.50 -0.20	1.5 MIN.	20.2 MIN.	12.0 ±0.30	1.75 ±0.10	5.50 ±0.10
	P0	P1	P2	D0	D1	T	A0	B0	K0
	4.00 ±0.10	8.00 ±0.10	2.00 ±0.10	1.5+0.10 -0.00	1.5 MIN.	0.6+0.00 -0.40	6.40 ±0.20	5.20 ±0.20	1.60 ±0.20

(mm)

Devices Per Unit

Package Type	Unit	Quantity
TSSOP-14	Tape & Reel	2500

Taping Direction Information

TSSOP-14

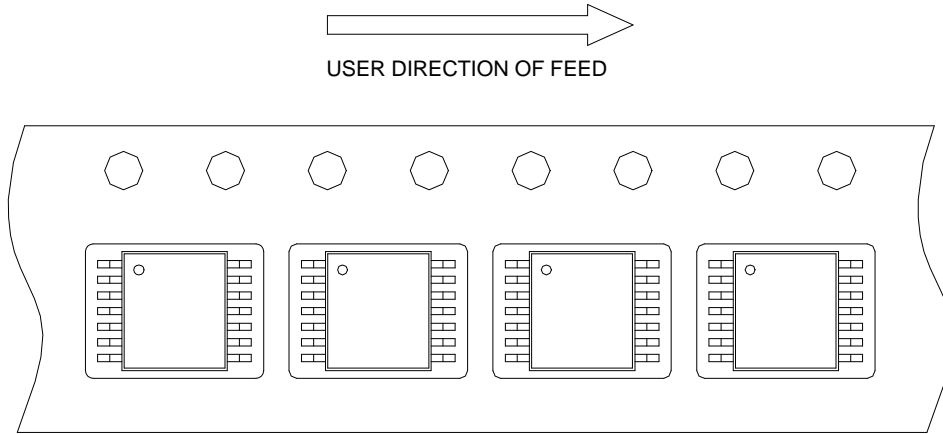

Classification Profile

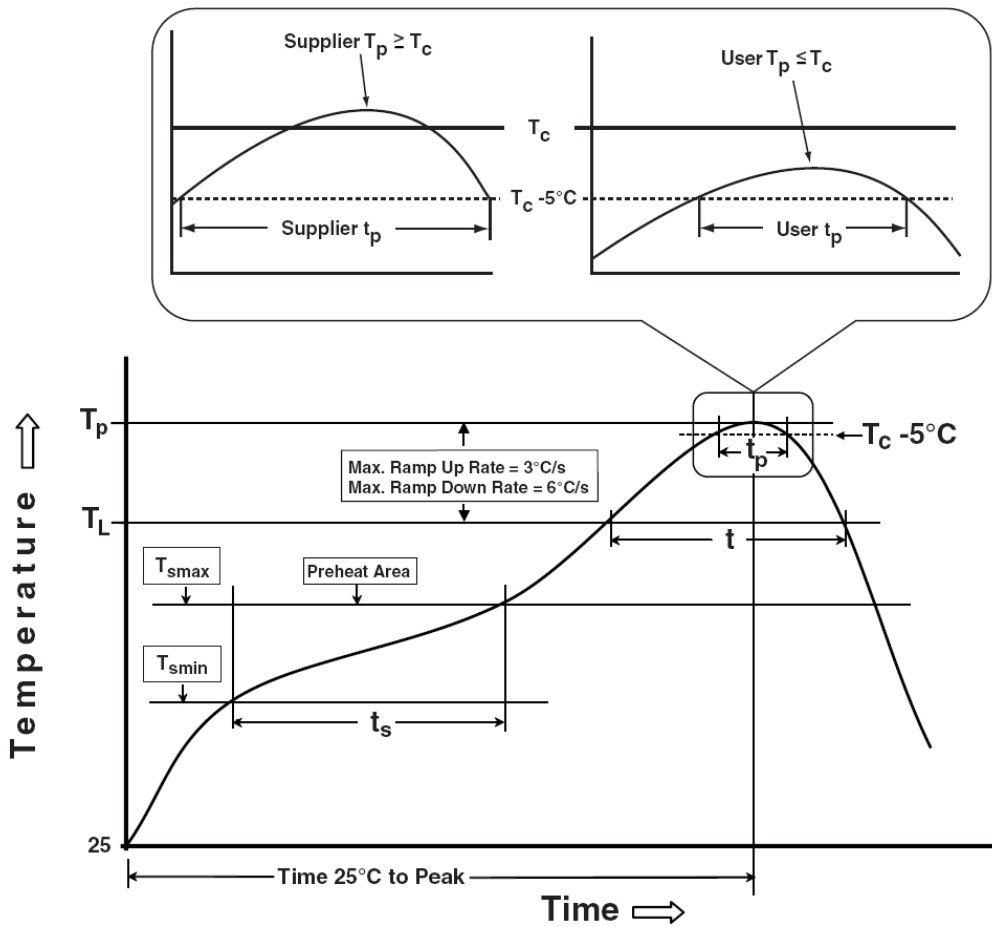

Classification Reflow Profiles

Profile Feature	Sn-Pb Eutectic Assembly	Pb-Free Assembly
Preheat & Soak		
Temperature min (T_{smin})	100 °C	150 °C
Temperature max (T_{smax})	150 °C	200 °C
Time (T_{smin} to T_{smax}) (t_s)	60-120 seconds	60-120 seconds
Average ramp-up rate (T_{smax} to T_p)	3 °C/second max.	3°C/second max.
Liquidous temperature (T_L)	183 °C	217 °C
Time at liquidous (t_L)	60-150 seconds	60-150 seconds
Peak package body Temperature (T_p)*	See Classification Temp in table 1	See Classification Temp in table 2
Time (t_p)** within 5°C of the specified classification temperature (T_c)	20** seconds	30** seconds
Average ramp-down rate (T_p to T_{smax})	6 °C/second max.	6 °C/second max.
Time 25°C to peak temperature	6 minutes max.	8 minutes max.
* Tolerance for peak profile Temperature (T_p) is defined as a supplier minimum and a user maximum.		
** Tolerance for time at peak profile temperature (t_p) is defined as a supplier minimum and a user maximum.		

Table 1. SnPb Eutectic Process – Classification Temperatures (T_c)

Package Thickness	Volume mm ³ <350	Volume mm ³ ≈350
<2.5 mm	235 °C	220 °C
≥2.5 mm	220 °C	220 °C

Table 2. Pb-free Process – Classification Temperatures (T_c)

Package Thickness	Volume mm ³ <350	Volume mm ³ 350-2000	Volume mm ³ >2000
<1.6 mm	260 °C	260 °C	260 °C
1.6 mm – 2.5 mm	260 °C	250 °C	245 °C
≥2.5 mm	250 °C	245 °C	245 °C

Reliability Test Program

Test item	Method	Description
SOLDERABILITY	JESD-22, B102	5 Sec, 245°C
HOLT	JESD-22, A108	1000 Hrs, Bias @ 125°C
PCT	JESD-22, A102	168 Hrs, 100%RH, 2atm, 121°C
TCT	JESD-22, A104	500 Cycles, -65°C~150°C
HBM	MIL-STD-883-3015.7	VHBM 2KV
MM	JESD-22, A115	VMM 200V
Latch-Up	JESD 78	10ms, 1 _{tr} 100mA

Customer Service

Anpec Electronics Corp.

Head Office :

No.6, Dusing 1st Road, SBIP,

Hsin-Chu, Taiwan, R.O.C.

Tel : 886-3-5642000

Fax : 886-3-5642050

Taipei Branch :

2F, No. 11, Lane 218, Sec 2 Jhongsing Rd.,

Sindian City, Taipei County 23146, Taiwan

Tel : 886-2-2910-3838

Fax : 886-2-2917-3838