

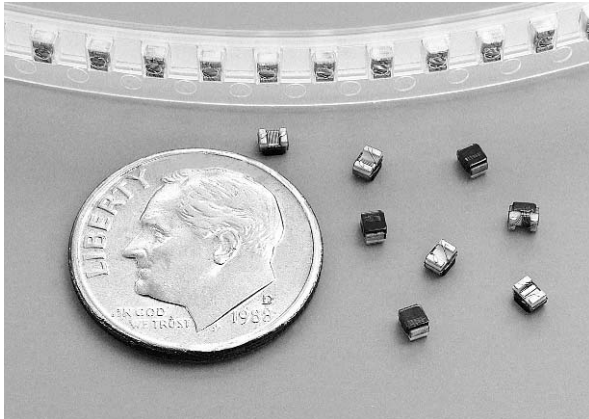



# WIRE-WOUND RF CHIP INDUCTORS - 0805CM SERIES



-  Wirewound ceramic core construction
-  High Q values and self-resonant frequency
-  Industry standard 0805 (2012) surface mount land pattern
-  Refer to page 3 for Competition Cross Reference

## Electrical Specifications @ 25°C

Part Number	Inductance <sup>1</sup> (nH)	Standard Tolerance	Optional Tolerance	Q <sup>2</sup> (MIN)	SRF <sup>3</sup> (MHz MIN)	R <sub>DC</sub> <sup>4</sup> (Ω MAX)	I <sub>DC</sub> <sup>5</sup> (mA MAX)
PE-0805CM030KTT	3.3 @ 250 MHz	± 10% (K)	±5% (J), ±2% (G), ±1% (F)	37 @ 1500 MHz	5000	0.08	600
PE-0805CM060KTT	6.8 @ 250 MHz	± 10% (K)	±5% (J), ±2% (G), ±1% (F)	46 @ 1000 MHz	5000	0.15	600
PE-0805CM080KTT	8.2 @ 250 MHz	± 10% (K)	±5% (J), ±2% (G), ±1% (F)	47 @ 1000 MHz	3900	0.13	600
PE-0805CM120KTT	12 @ 250 MHz	± 10% (K)	±5% (J), ±2% (G), ±1% (F)	50 @ 500 MHz	2900	0.13	600
PE-0805CM150KTT	15 @ 250 MHz	± 10% (K)	±5% (J), ±2% (G), ±1% (F)	50 @ 500 MHz	2700	0.15	600
PE-0805CM180KTT	18 @ 250 MHz	± 10% (K)	±5% (J), ±2% (G), ±1% (F)	50 @ 500 MHz	2600	0.13	600
PE-0805CM220KTT	22 @ 250 MHz	± 10% (K)	±5% (J), ±2% (G), ±1% (F)	55 @ 500 MHz	2200	0.13	500
PE-0805CM270KTT	27 @ 250 MHz	± 10% (K)	±5% (J), ±2% (G), ±1% (F)	55 @ 500 MHz	2000	0.23	500
PE-0805CM330KTT	33 @ 250 MHz	± 10% (K)	±5% (J), ±2% (G), ±1% (F)	58 @ 500 MHz	1800	0.18	500
PE-0805CM390KTT	39 @ 250 MHz	± 10% (K)	±5% (J), ±2% (G), ±1% (F)	60 @ 500 MHz	1600	0.23	500
PE-0805CM470KTT	47 @ 200 MHz	± 10% (K)	±5% (J), ±2% (G), ±1% (F)	60 @ 500 MHz	1650	0.25	500
PE-0805CM560KTT	56 @ 200 MHz	± 10% (K)	±5% (J), ±2% (G), ±1% (F)	60 @ 500 MHz	1300	0.16	500
PE-0805CM680KTT	68 @ 200 MHz	± 10% (K)	±5% (J), ±2% (G), ±1% (F)	60 @ 500 MHz	1350	0.18	500
PE-0805CM820KTT	82 @ 150 MHz	± 10% (K)	±5% (J), ±2% (G), ±1% (F)	60 @ 500 MHz	1300	0.36	400
PE-0805CM101KTT	100 @ 150 MHz	± 10% (K)	±5% (J), ±2% (G), ±1% (F)	55 @ 500 MHz	1100	0.36	400
PE-0805CM121KTT	120 @ 150 MHz	± 10% (K)	±5% (J), ±2% (G), ±1% (F)	45 @ 250 MHz	1100	0.56	350
PE-0805CM151KTT	150 @ 100 MHz	± 10% (K)	±5% (J), ±2% (G), ±1% (F)	50 @ 250 MHz	900	0.56	350
PE-0805CM181KTT	180 @ 100 MHz	± 10% (K)	±5% (J), ±2% (G), ±1% (F)	50 @ 250 MHz	875	0.69	300
PE-0805CM221KTT	220 @ 100 MHz	± 10% (K)	±5% (J), ±2% (G), ±1% (F)	45 @ 250 MHz	800	0.85	300
PE-0805CM271KTT	270 @ 100 MHz	± 10% (K)	±5% (J), ±2% (G), ±1% (F)	40 @ 100 MHz	800	0.90	300
PE-0805CM331KTT	330 @ 100 MHz	± 10% (K)	±5% (J), ±2% (G), ±1% (F)	40 @ 100 MHz	775	1.28	300
PE-0805CM391KTT	390 @ 100 MHz	± 10% (K)	±5% (J), ±2% (G), ±1% (F)	40 @ 100 MHz	725	1.70	300
PE-0805CM471KTT	470 @ 100 MHz	± 10% (K)	±5% (J), ±2% (G), ±1% (F)	38 @ 100 MHz	600	3.25	240
PE-0805CM561KTT	560 @ 100 MHz	± 10% (K)	±5% (J), ±2% (G), ±1% (F)	40 @ 100 MHz	600	3.10	240
PE-0805CM681KTT	680 @ 50 MHz	± 10% (K)	±5% (J), ±2% (G), ±1% (F)	32 @ 50 MHz	550	3.50	240

### NOTES:

1. Inductance measured using a HP4286A RF Impedance Analyzer.
2. Q measured using a HP4291A RF Impedance Analyzer with a HP16193A Test Fixture.
3. SRF measured using a HP8753C Network Analyzer.
4. R<sub>DC</sub> measured using a Valhalla Scientific model 4100 ATC Digital Ohmmeter.
5. Based on a 15°C maximum temperature rise.

# WIRE-WOUND RF CHIP INDUCTORS - 0805CM SERIES



Typical Q vs Frequency

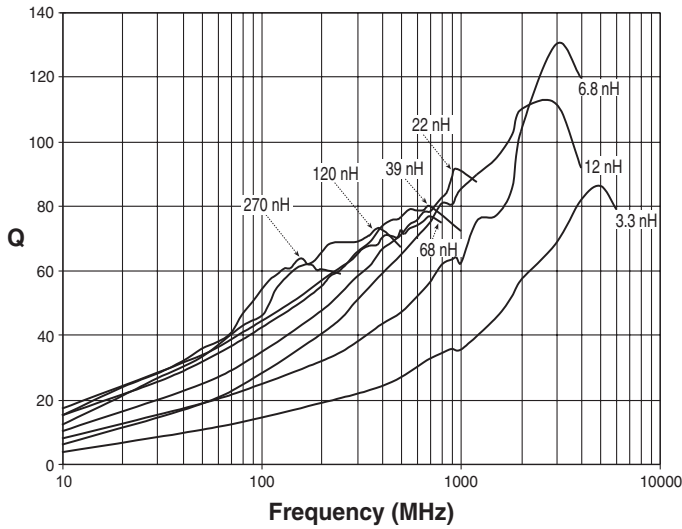

Typical Inductance vs Frequency

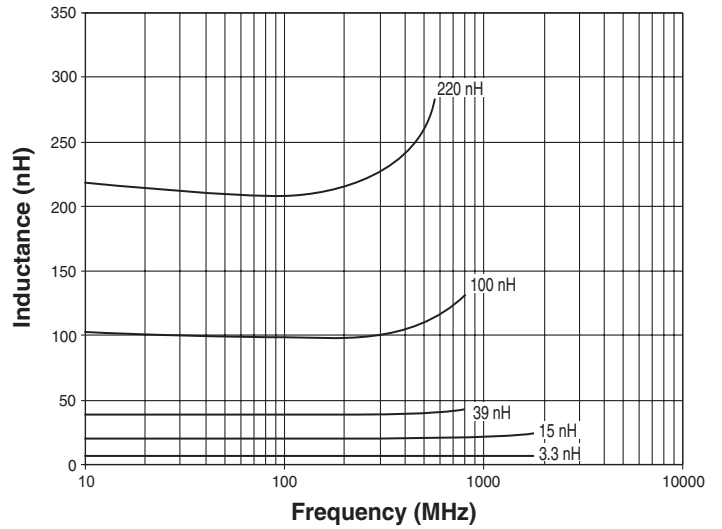

## Mechanical

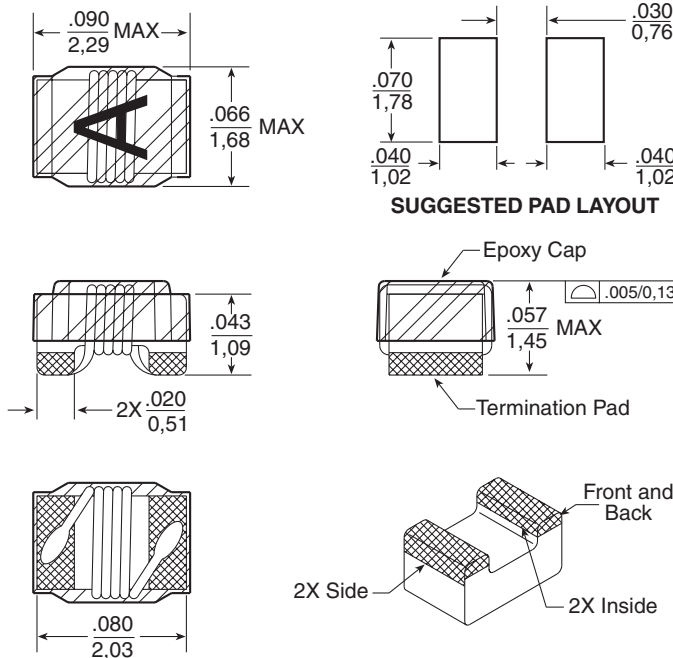

Weight . . . . . 0.012 grams  
Tape & Reel . . . . . 2000/reel  
Dimensions:  $\frac{\text{Inches}}{\text{mm}}$   
Unless otherwise specified  
all tolerances are  $\pm \frac{.010}{0.25}$