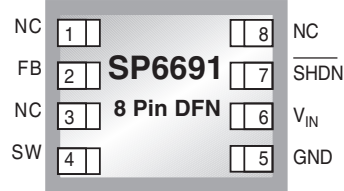


## Micro Power Boost Regulator Series White LED Driver

### FEATURES

- Drives up to 6 LED's @ 25mA
- Drives up to 8 LED's @ 20mA
- High Output Voltage: Up to 34V
- Optimized for Single Supply, 2.7V - 4.2V Applications
- Operates Down to 1V
- High Efficiency: Greater Than 75%
- Low Quiescent Current: 20 $\mu$ A
- Ultra Low Shutdown Current: 10nA
- Single Battery Cell Operation
- Programmable Output Voltage
- 1 $\Omega$  switch (350mV at 350mA)
- Available in 8 Pin DFN, 5 Pin TSOT or 5 Pin SOT23



*Now Available in Lead Free Packaging*

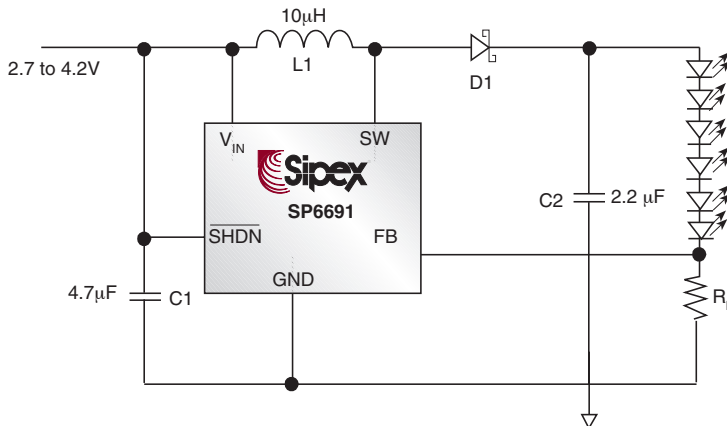
### APPLICATIONS

- White LED Driver
- High Voltage Bias
- Digital Cameras
- Cell Phone
- Battery Backup
- Handheld Computers

### DESCRIPTION

The SP6691 is a micro power boost regulator that is specifically designed for powering series configuration white LED. The part utilizes fixed off time architecture and consumes only 10nA quiescent current in shutdown. Low voltage operation, down to 1V, fully utilizes maximal battery life. The SP6691 is offered in a 8 Pin DFN, 5-pin SOT-23 or 5 Pin TSOT package and enables the construction of a complete regulator occupying < 0.2 in<sup>2</sup> board space.

### TYPICAL APPLICATION CIRCUIT



## ABSOLUTE MAXIMUM RATINGS

$V_{IN}$  ..... 15V  
 SW Voltage ..... -0.4 to 34V  
 FB Voltage ..... 2.5V  
 All other pins ..... -0.3 to  $V_{IN} + 0.3V$   
 Current into FB .....  $\pm 1mA$   
 $T_J$  Max ..... 125°C  
 Operating Temperature Range ..... -40°C to 85°C  
 Peak Output Current < 10us SW ..... 500mA

Storage Temperature ..... -65°C to +150°C  
 Power Dissipation ..... 200mW  
 ESD Rating ..... 2kV HBM

These are stress ratings only and functional operation of the device at these ratings or any other above those indicated in the operation sections of the specifications below is not implied. Exposure to absolute maximum rating conditions for extended periods of time may affect reliability.

## ELECTRICAL CHARACTERISTICS

Specifications are at  $T_A = 25^\circ C$ ,  $V_{IN} = 3.3$ ,  $V_{SHDN} = V_{IN}$ . ♦ denotes the specifications which apply over the full operating temperature range, unless otherwise specified.

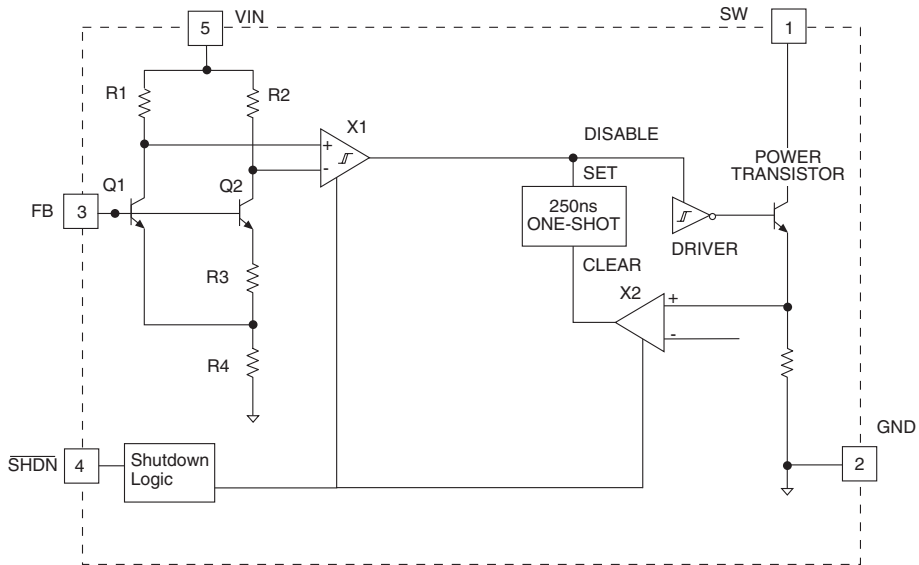
PARAMETER	SYMBOL	MIN	TYP	MAX	UNITS	♦	CONDITIONS
Input Voltage	$V_{IN}$	1.0		13.5	V		
Supply Current	$I_Q$		20	30	$\mu A$	♦	No Switching
			0.01	1	$\mu A$	♦	$\overline{SHDN} = 0V$ (off)
Reference Voltage	$V_{FB}$	1.17	1.22	1.27	V	♦	
FB Hysteresis	HYST		8		mV		
$V_{FB}$ Input Bias Current	$I_{FB}$		15	80	nA	♦	$V_{FB} = 1.22V$
Line Regulation	$\Delta V_O / \Delta V_I$		0.1	0.3	%/V		$1.2 \leq V_{IN} \leq 13.5V$
Switch Off Time	$T_{OFF}$		250		nS		
Switch Saturation Voltage	$V_{CESAT}$		170	450	mV	♦	$I_{SW} = 325mA$
Switch Current Limit	$I_{LIM}$	325	450	575	mA	♦	
$\overline{SHDN}$ Bias Current	$I_{SHDN}$		5	12	$\mu A$	♦	$V_{SHDN} = 3.3V$
$\overline{SHDN}$ High Threshold (on)	$V_{IH}$	0.9			V		
$\overline{SHDN}$ Low Threshold (off)	$V_{IL}$			0.25	V		
Switch Leakage Current	$I_{SWLK}$		0.01	5	$\mu A$	♦	Switch Off, $V_{SW} = 5V$

## PIN DESCRIPTION

PIN NUMBER	PIN NAME	8 PIN DFN DESCRIPTION
1	NC	No connect.
2	FB	Feedback.
3	NC	No connect.
3	SW	Switch input to the internal power switch
5	GND	Ground
6	$V_{IN}$	Input Voltage. Bypass this pin with a capacitor as close to the device as possible.
7	$\overline{SHDN}$	Shutdown. Pull high (on) to enable. Pull low (off) for shutdown.
8	NC	No connect.

PIN NUMBER	PIN NAME	DESCRIPTION
1	SW	Switch input to the internal power switch.
2	GND	Ground
3	FB	Feedback
4	$\overline{\text{SHDN}}$	Shutdown. Pull high (on) to enable. Pull low (off) for shutdown.
5	V <sub>IN</sub>	Input Voltage. Bypass this pin with a capacitor as close to the device as possible.

FUNCTIONAL DIAGRAM



THEORY OF OPERATION

Operation can be best understood by referring to the functional diagram above and the typical application circuit in the front page. Q1 and Q2 along with R3 and R4 form a band gap reference. The input to this circuit completes a feedback path from the high voltage output through a voltage divider, and is used as the regulation control input. When the voltage at the FB pin is slightly above 1.22V, comparator X1 disables most of the internal circuitry. Current is then provided by capacitor C2, which slowly discharges until the voltage at the FB pin drops below the lower hysteresis point of X1, about 6mV. X1 then enables the internal circuitry, turns on chip power, and the current in the inductor begins to ramp up. When the current through the driver transistor reaches about

450mA, comparator X2 clears the latch, which turns off the driver transistor for a preset 250nS. At the instant of shutoff, inductor current is diverted to the output through diode D1. During this 250nS time limit, inductor current decreases while its energy charges C2.

At the end of the 250ns time period, driver transistor is again allowed to turn on which ramps the current back up to the 450mA level. Comparator X2 clears the latch, it's output turns off the driver transistor, and this allows delivery of L1's stored kinetic energy to C2. This switching action continues until the output capacitor voltage is charged to the point where FB is at band gap (1.22V). When this condition is reached, X1 turns off the internal circuitry and the cycle repeats.

# PERFORMANCE CHARACTERISTICS

Refer to the typical application circuit,  $T_{AMB} = 25^{\circ}\text{C}$ , unless otherwise specified.

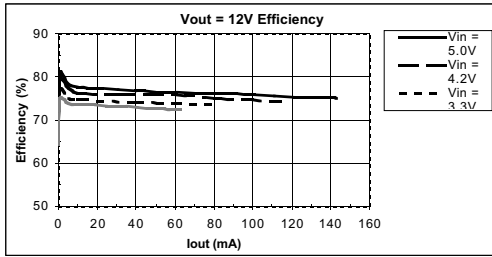


Figure 1. 12V Output Efficiency

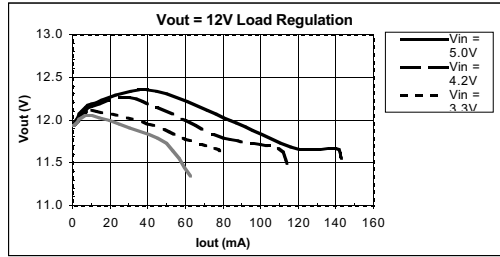


Figure 2. 12V Output Load Regulation

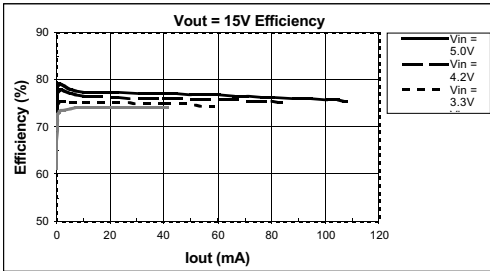


Figure 3. 15V Output Efficiency

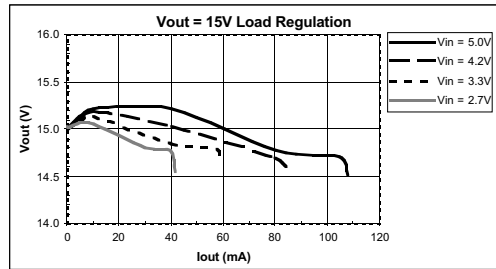


Figure 4. 15V Output Load Regulation

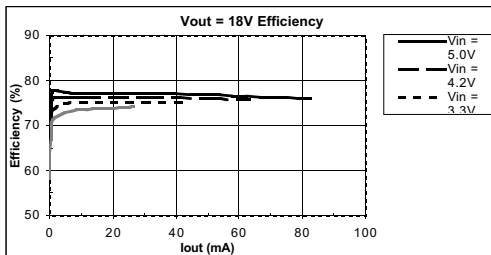


Figure 5. 18V Output Efficiency

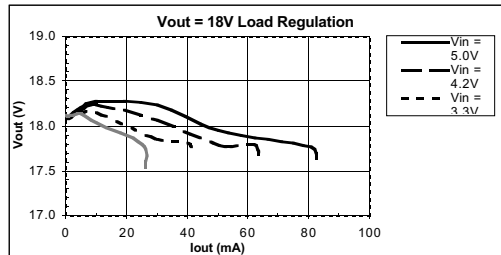


Figure 6. 18V Output Load Regulation

# PERFORMANCE CHARACTERISTICS

Refer to the typical application circuit,  $T_{AMB} = 25^{\circ}\text{C}$ , unless otherwise specified.

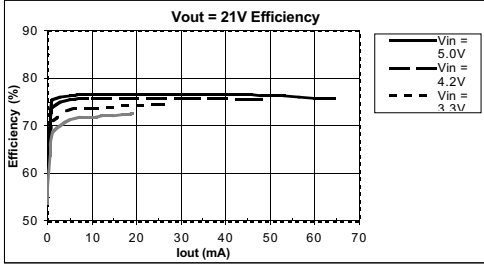


Figure 7. 21V Output Efficiency

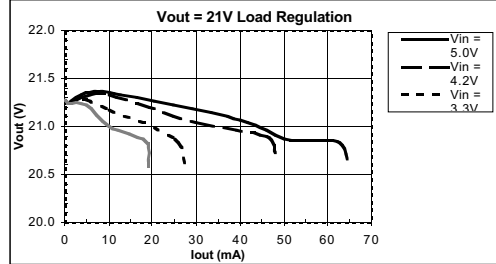


Figure 8. 21V Output Load Regulation

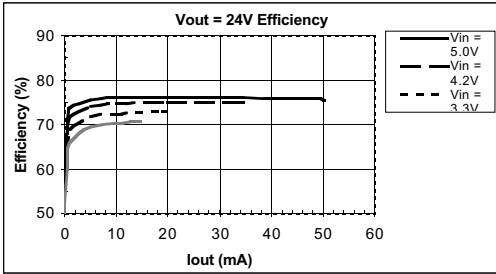


Figure 9. 24V Output Efficiency

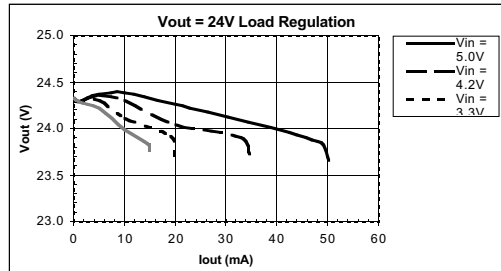


Figure 10. 24V Output Load Regulation

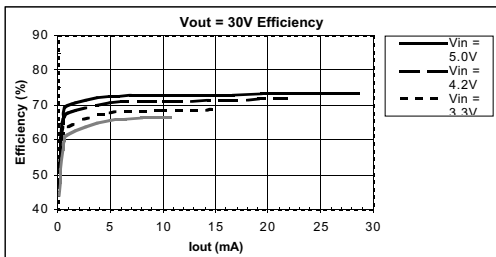


Figure 11. 30V Output Efficiency

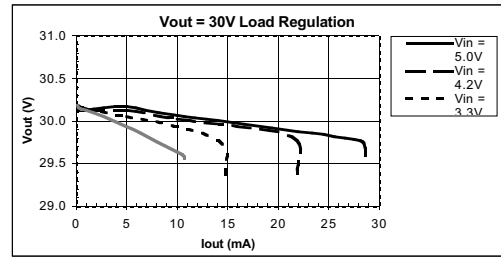


Figure 12. 30V Output Load Regulation

## PERFORMANCE CHARACTERISTICS

Refer to the typical application circuit,  $T_{AMB} = 25^{\circ}\text{C}$ , unless otherwise specified.

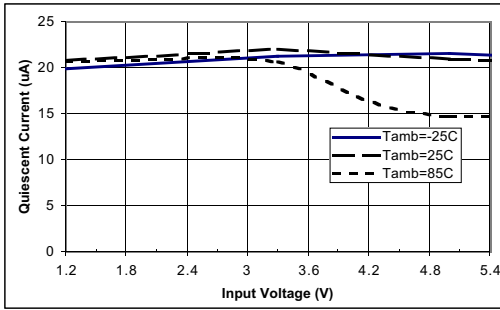


Figure 13. Quiescent Current  $I_Q$  vs.  $V_{IN}$

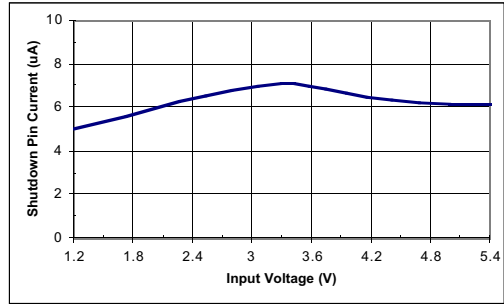


Figure 14. Shutdown Pin Current vs.  $V_{IN}$

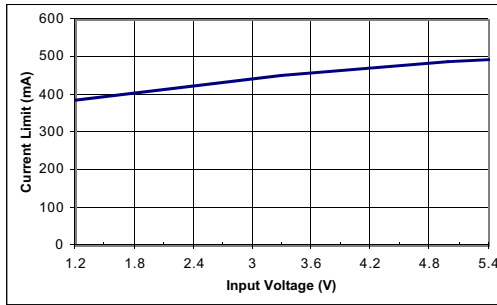


Figure 15.  $I_{PK}$  Current Limit vs.  $V_{IN}$

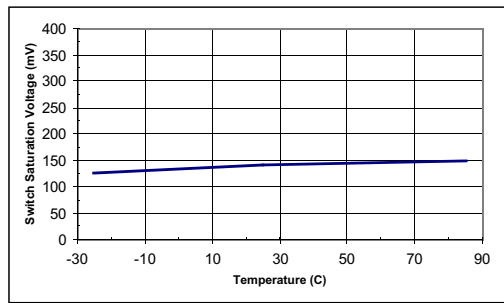


Figure 16. Switch Saturation Voltage  $V_{CESAT}$  vs. Temperature ( $I_{SW} = 450\text{mA}$ )

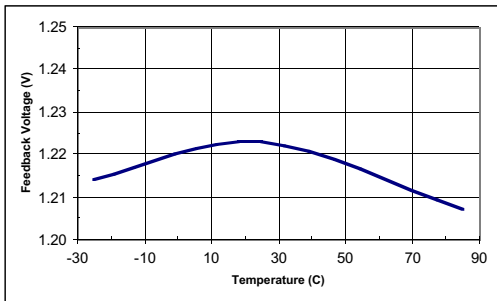


Figure 17. Feedback Voltage vs. Temperature

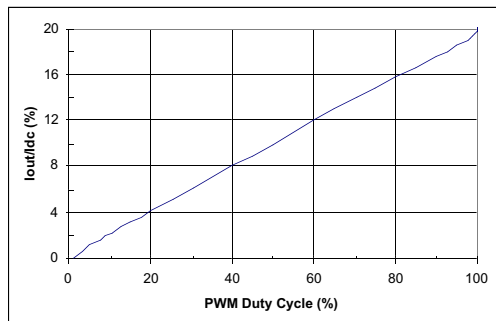


Figure 18. Average  $I_O$  vs. SHDN Duty Cycle ( $V_{IN} = 3.3\text{V}$ , Standard 4x20mA WLED Evaluation Board, PWM Frequency 100Hz)

# PERFORMANCE CHARACTERISTICS

Refer to the typical application circuit,  $T_{AMB} = 25^{\circ}\text{C}$ , unless otherwise specified.

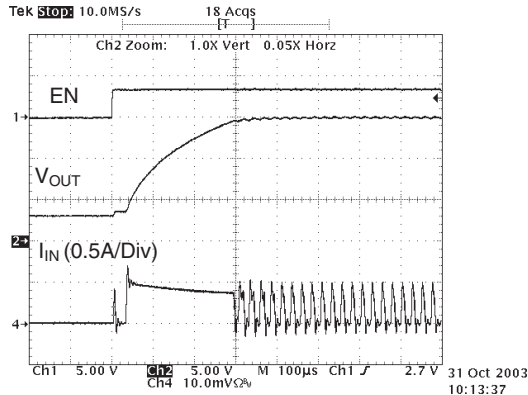


Figure 19. Startup Waveform ( $V_{IN}=3.3\text{V}$ ,  $V_{OUT}=15\text{V}$ ,  $I_{OUT}=20\text{mA}$ )

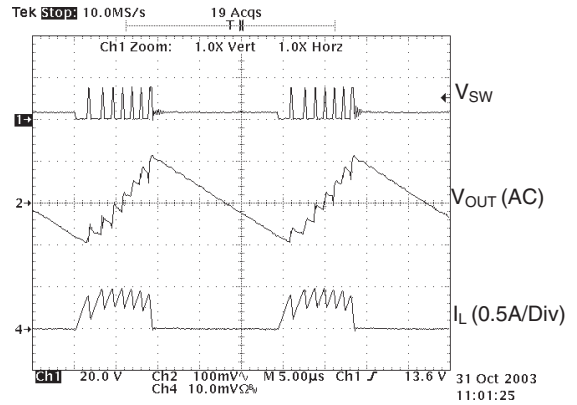


Figure 20. Typical Switching Waveforms ( $V_{IN}=3\text{V}$ ,  $V_{OUT}=15\text{V}$ ,  $I_{OUT}=20\text{mA}$ )

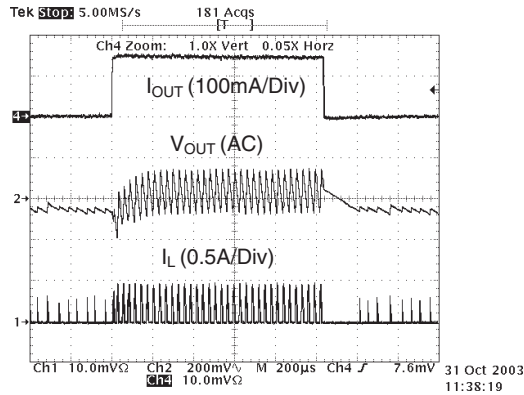


Figure 21. Load Step Transient ( $V_{IN}=3\text{V}$ ,  $V_{OUT}=21\text{V}$ , 1–15mA Load Step)

## Inductor Selection

For SP6691, the internal switch will be turned off only after the inductor current reaches the typical dc current limit ( $I_{LIM}=450\text{mA}$ ). However, there is typically propagation delay of 200nS between the time when the current limit is reached and when the switch is actually turned off. During this 200nS delay, the peak inductor current will increase, exceeding the current limit by a small amount. The peak inductor current can be estimated by:

$$I_{PK} = I_{LIM} + \frac{V_{IN(MAX)}}{L} \cdot 200\text{nS}$$

The larger the input voltage and the lower the inductor value, the greater the peak current.

In selecting an inductor, the saturation current specified for the inductor needs to be greater than the SP6691 peak current to avoid saturating the inductor, which would result in a loss in efficiency and could damage the inductor.

Choosing an inductor with low DCR decreases power losses and increase efficiency.

Refer to Table 1 for some suggested low ESR inductors.

Table 1. Suggested Low ESR inductor

MANUF.	PART NUMBER	DCR ( $\Omega$ )	Current Rating (mA)
MURATA 770-436-1300	LQH32CN100K11 (10 $\mu$ H)	0.3	450
TDK 847-803-6100	NLC453232T-100K (10 $\mu$ H)	0.55	500

## Diode Selection

A schottky diode with a low forward drop and fast switching speed is ideally used here to achieve high efficiency. In selecting a Schottky diode, the current rating of the schottky diode should be larger than the peak inductor current. Moreover, the reverse breakdown voltage of the schottky diode should be larger than the output voltage.

## Capacitor Selection

Ceramic capacitors are recommended for their inherently low ESR, which will help produce low peak to peak output ripple, and reduce high frequency spikes.

For the typical application, 4.7 $\mu$ F input capacitor and 2.2 $\mu$ F output capacitor are sufficient. The input and output ripple could be further reduced by increasing the value of the input and output capacitors. Place all the capacitors as close to the SP6691 as possible for layout. For use as a voltage source, to reduce the output ripple, a small feedforward (47pF) across the top feedback resistor can be used to provide sufficient overdrive for the error comparator, thus reduce the output ripple.

Refer to Table 2 for some suggested low ESR capacitors.

Table 2. Suggested Low ESR Capacitor

MANUF.	PART NUMBER	CAP /VOLTAGE	SIZE /TYPE
MURATA 770-436-1300	GRM32RR71E 225KC01B	2.2 $\mu$ F /25V	1210 /X5R
MURATA 770-436-1300	GRM31CR61A 475KA01B	4.7 $\mu$ F /10V	1206 /X5R
TDK 847-803-6100	C3225X7R1E 225M	2.2 $\mu$ F /25V	1210 /X7R
TDK 847-803-6100	C3216X5R1A 475K	4.7 $\mu$ F /10V	1206 /X5R

## LED Current Program

In the white LEDs application, the SP6691 is generally programmed as a current source. The bias resistor  $R_b$ , as shown in the typical application circuit is used to set the operating current of the white LED using the equation:

$$R_b = \frac{V_{FB}}{I_F}$$

where  $V_{FB}$  is the feedback pin voltage (1.22V),  $I_F$  is the operating current of the White LEDs. In order to achieve accurate LED current, 1%



precision resistors are recommended. Table 3 below shows the  $R_b$  selection for different white LED currents. For example, to set the operating current to be 20mA,  $R_b$  is selected as 60.4  $\Omega$ , as shown in the schematic.

Table 3. Bias Resistor Selection

$I_F$ (mA)	$R_b$ ( $\Omega$ )
5	243
10	121
12	102
15	80.6
20	60.4

**Output Voltage Program**

The SP6691 can be programmed as either a voltage source or a current source. To program the SP6691 as voltage source, the SP6691 requires 2 feedback resistors  $R_1$  &  $R_2$  to control the output voltage. As shown in Figure 22.

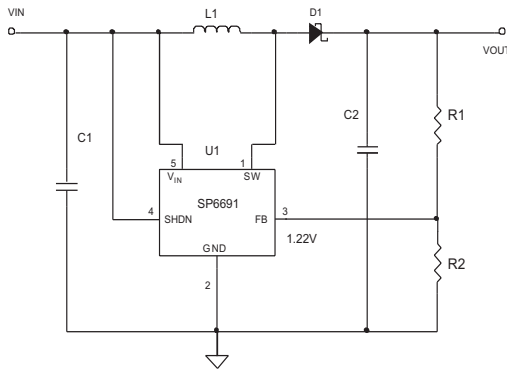


Figure 22. Using SP6691 as Voltage Source

The formula and table for the resistor selection are shown below:

$$R_1 = \left( \frac{V_{OUT}}{1.22} - 1 \right) \cdot R_2$$

Table 4. Divider Resistor Selection

$V_{OUT}$ (V)	$R_1$ ( $\Omega$ )	$R_2$ ( $\Omega$ )
12	1M	113K
15	1M	88.7K
18	1M	73.2K
21	1M	61.9K
30	1M	42.2K

**Brightness Control**

Dimming control can be achieved by applying a PWM control signal to the SHDN pin. The brightness of the white LEDs is controlled by increasing and decreasing the duty cycle of the PWM signal. A 0% duty cycle corresponds to zero LED current and a 100% duty cycle corresponds to full load current. While the operating frequency range of the PWM control is from 60Hz to 700Hz, the recommended maximum brightness frequency range of the PWM signal is from 60Hz to 200Hz. A repetition rate of at least 60Hz is required to prevent flicker. The magnitude of the PWM signal should be higher than the minimum SHDN voltage high.

**Open Circuit Protection**

When any white LED inside the white LED module fails or the LED module is disconnected from the circuit, the output and the feedback control will be open, thus resulting in a high output voltage, which may cause the SW pin voltage to exceed its maximum rating. In this case, a zener diode can be used at the output to limit the voltage on the SW pin and protect the part. The zener voltage should be larger than the maximum forward voltage of the White LED module.

**Layout Consideration**

Both the input capacitor and the output capacitor should be placed as close as possible to the IC.

This can reduce the copper trace resistance which directly effects the input and output ripples. The feedback resistor network should be kept close to the FB pin to minimize copper trace connections that can inject noise into the system. The ground connection for the feedback resistor network should connect directly to the GND pin or to an analog ground plane that is tied directly to the GND pin. The inductor and the schottky diode should be placed as close as possible to the switch pin to minimize the noise coupling to the other circuits, especially the feedback network.

**Power Efficiency**

For the typical application circuit, the output efficiency of the circuit is expressed by

$$\eta = \frac{V_{OUT} \cdot I_{OUT}}{V_{IN} \cdot I_{IN}}$$

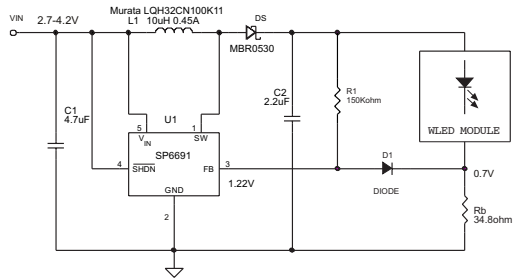
Where  $V_{IN}$ ,  $I_{IN}$ ,  $V_{OUT}$ ,  $I_{OUT}$  are the input and output voltage and current respectively.

While the white LED efficiency is expressed by

$$\eta = \frac{(V_{OUT} - 1.22) \cdot I_{OUT}}{V_{IN} \cdot I_{IN}}$$

This equation indicates that the white LED efficiency will be much smaller than the output efficiency of the circuit when  $V_{OUT}$  is not very large, compared to the feedback voltage (1.22V).

The other power is consumed by the bias resistor. To reduce this power loss, two circuits can be used, as shown in Figure 23 and Figure 24. In Figure 23, a general-purpose diode (for example, 1N4148) is used to bring the voltage across the bias resistor to be around 0.7V.  $R_1$  is used to create a loop that provides around 100 $\mu$ A operating current for the diode. 3% efficiency improvement can be achieved by using this method.

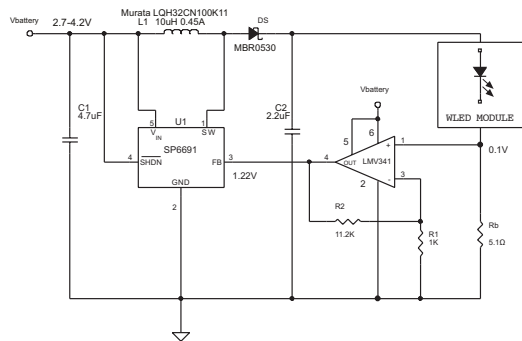


**Figure 23. Improve Efficiency with Diode in Feedback Loop**

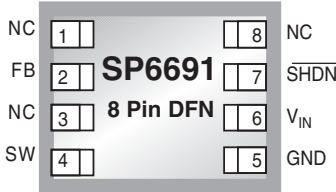
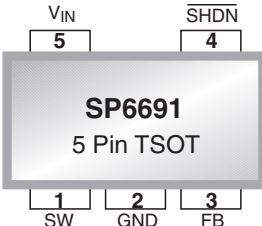
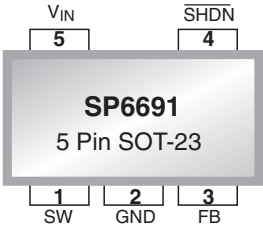
To further improve the efficiency and reduce the effects of the ambient temperature on the diode D1 used in method 1, an op amp circuit can be used as shown in Figure 24. The gain of the op amp circuit can be calculated by:

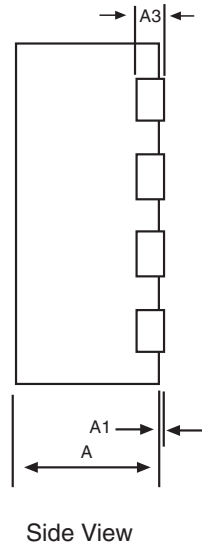
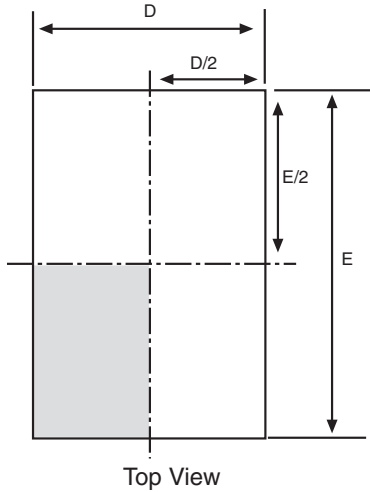
$$A_V = \frac{R_1 + R_2}{R_1}$$

If the voltage across the bias resistor is set to be 0.1V the current through  $R_1$  and  $R_2$  to be around 100 $\mu$ A,  $R_1$  and  $R_2$  can be selected as 1K and 11.2K respectively. LMV341 can be used because of its small supply current, offset voltage and minimum supply voltage. By using this method, the efficiency can be increased around 7%.

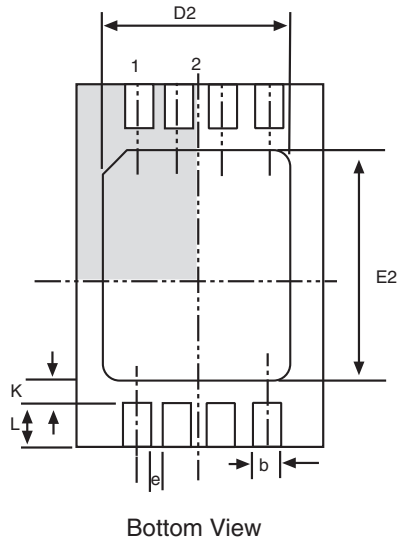


**Figure 24. Improve Efficiency with Op Amp in Feedback Loop**

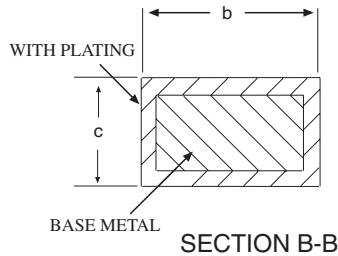
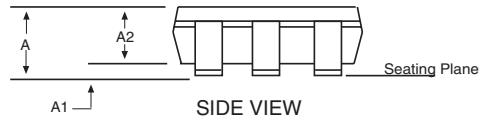
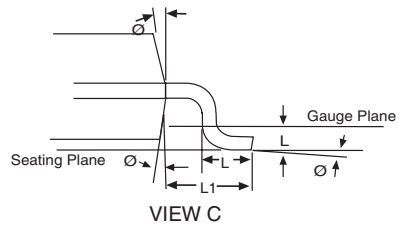
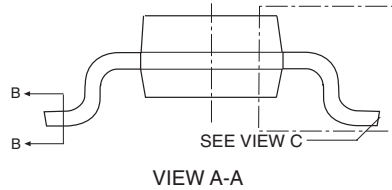
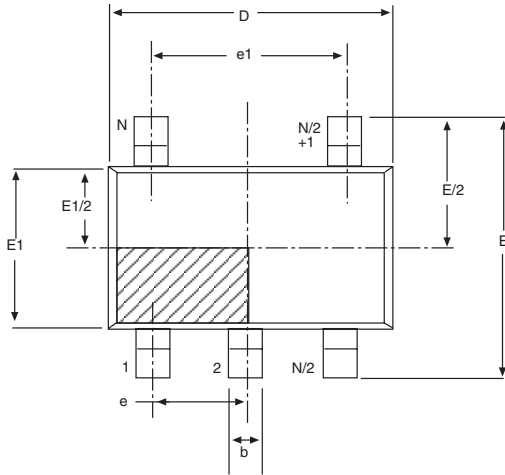




2x3 8 Pin DFN JEDEC MO-229 (VCED-2) VARIATION			
SYMBOL	MIN	NOM	MAX
A	0.8	0.9	1
A1	0	0.02	0.05
A3	0.20 REF		
b	0.18	0.25	0.3
D	2.00 BSC		
D2	1.5		1.75
e	-	0.5	-
E	3.00 BSC		
E2	1.6	-	1.9
K	0.2	-	-
L	0.3	0.4	0.5

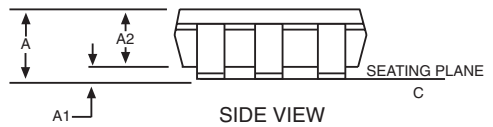
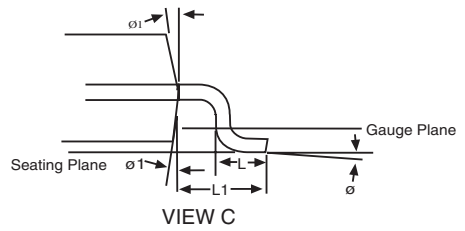
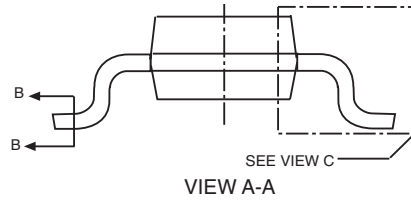
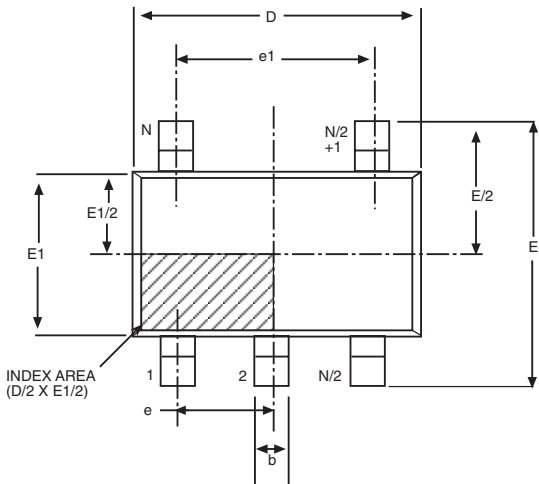


Note: Dimensions in (mm)



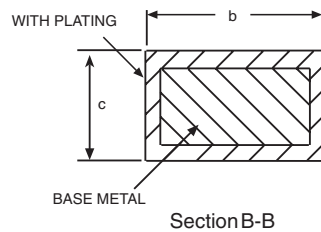
5 Pin SOT-23 JEDEC MO-178 (AA) Variation			
SYMBOL	MIN	NOM	MAX
A	-	-	1.45
A1	0	-	0.15
A2	0.9	1.15	1.3
b	0.3	-	0.5
c	0.08	-	0.22
D	2.90 BSC		
E	2.80 BSC		
E1	1.60 BSC		
e	0.95 BSC		
e1	1.90 BSC		
L	0.3	0.45	0.6
L1	0.60 REF		
L2	0.25 BSC		
$\phi$	0°	4°	8°
$\phi$	5°	10°	15°

Note: Dimensions in (mm)



5 Pin TSOT JEDEC MO-193 (AB) Variation			
SYMBOL	MIN	NOM	MAX
A	-	-	1.1
A1	0	-	0.1
A2	0.7	0.9	1
b	0.3	-	0.5
c	0.08	-	0.2
D	2.90 BSC		
e	0.95 BSC		
e1	1.90 BSC		
E	2.80 BSC		
E1	1.60 BSC		
L	0.3	0.45	0.6
L1	0.60 REF		
L2	0.25 BSC		
$\phi$	0°	4°	8°
$\phi 1$	4°	10°	12°

Note: Dimensions in (mm)



**ORDERING INFORMATION**

<b>Part Number</b>	<b>Temperature Range</b>	<b>Package Type</b>
SP6691EK1 .....	-40°C to +85°C .....	5 Pin TSOT
SP6691EK1/TR .....	-40°C to +85°C .....	5 Pin TSOT
SP6691EK .....	-40°C to +85°C .....	5 Pin SOT-23
SP6691EK/TR .....	-40°C to +85°C .....	5 Pin SOT-23
SP6691ER .....	-40°C to +85°C .....	8 Pin DFN
SP6691ER/TR .....	-40°C to +85°C .....	8 Pin DFN

Available in lead free packaging. To order add "-L" suffix to part number.

Example: SP6691ER/TR = standard; SP6691ER-L/TR = lead free

/TR = Tape and Reel

Pack quantity is 2,500 for TSOT or SOT-23 and 3,000 for DFN.

 [CLICK HERE TO ORDER SAMPLES](#) 



**ANALOG EXCELLENCE**

**Sipex Corporation**

**Headquarters and Sales Office**  
233 South Hillview Drive  
Milpitas, CA 95035  
TEL: (408) 934-7500  
FAX: (408) 935-7600

Sipex Corporation reserves the right to make changes to any products described herein. Sipex does not assume any liability arising out of the application or use of any product or circuit described herein; neither does it convey any license under its patent rights nor the rights of others.