

DPGM/DPJM/DPJMB

Environmental, Rectangular Connectors for Aircraft, Missile and Ground Support Equipment Applications

Cannon's DPGM, DPJM, and DPJMB connectors are designed for applications where space and weight are prime considerations. Their rectangular shape provides maximum space utilization and permits easy removal of equipment for inspection and/or repair. DPGM and DPJM connectors feature crimp snap-in contacts with ring-type retention while DPJMB connectors feature the LITTLE CAESAR® rear release contact retention assembly (rear insertion, release and extraction of crimp snap-in contacts). They both have one piece diallyl phthalate insulators with polychloroprene wire sealing grommets. They also incorporate a peripheral seal design that allows an axial tolerance of up to .125 (3.175) while still effecting a seal. The 34 shell utilizes a rubber seal encased in such a way that the step down design of the mating 33 shell seats into and against it.

All of these connectors utilize keystone corners for polarization and are coupled by friction. Two shell styles with different mounting provisions are available.



For all new applications, the referenced connectors will be available only with insulators in the normal position, that is, pin insulators in the 34 (receptacle) shells and socket insulators in the 33 (plug) shells.

For replacements it is suggested that where practical, customers using these connectors with reversed insulators change to connectors with insulators in the normal position. However, for those who are unable to change we will furnish connectors with reversed insulators to maintain their equipment usage.

Standard Data

		DPGM/DPJM/DPJMB
Shell	Material	Aluminum alloy
	Finish	Cadmium plate with olive drab irridite
Insulator	Material	Diallyl phthalate
	Material	Copper alloy
Contacts	Finish	Gold plate
	Termination	Crimp
	No. of Contacts	8, 12, 15, 16, 20, 21, 32, 59, 98
Contact Arrangements		

How To Order

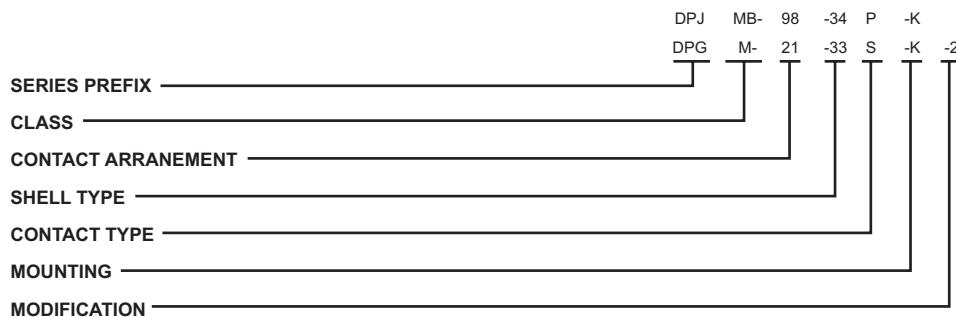

Contacts, coaxials and junction shells must be ordered separately, except for the DPJMB where the contacts are supplied with the connector. When (ordering or reordering) please specify the 3-4-3 contact part number as shown. We have cross-referenced these new part numbers with the previous part numbers (which have been obsoleted) for your convenience.

Example:

031-0900-001 new "3-4-3" part number
 (038819-001) previous part number

SERIES PREFIX

DPG, DPJ

CLASS

M - One piece insulator ring - type retention
 MB - LITTLE CAESAR contact retention assembly

CONTACT ARRANGEMENTS

DPGM - C8, 12, 15, 16, 20C4, 21 and 32
 DPJM - C21, 59, 59C10, and 98
 DPJMB - 59, 98

SHELL TYPE

33 for plug, 34 for receptacle

CONTACT TYPE

P for pin, S for socket

MOUNTING

33-K-With 6-32 clinch nuts
 33-B-Clearance holes for 6-32 screw
 34-K-Floating eyelet with 6-32 tapped I.D.
 34-B-Floating eyelet with .140 I.D.

MODIFICATION

-2-.125 (3.18) removed from front lip of -33 shell



Shell Dimensions - DPGM

33 SHELL

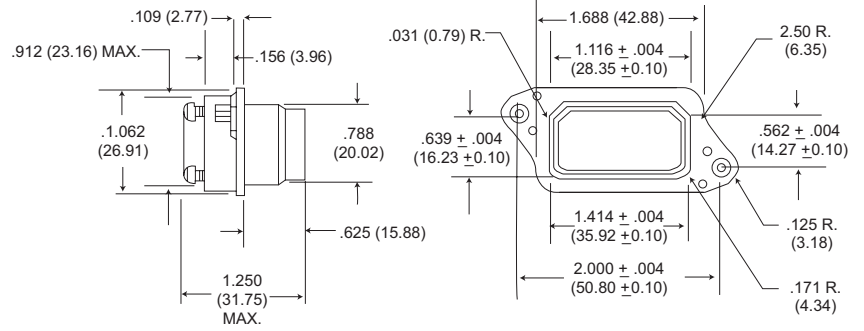

34 SHELL

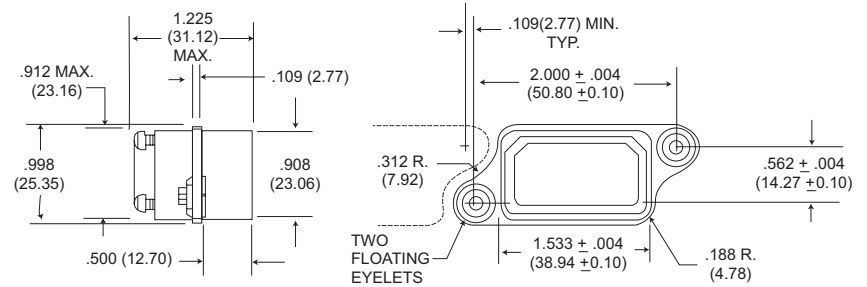

Shell Dimensions -DPJM/DPJMB

33 SHELL

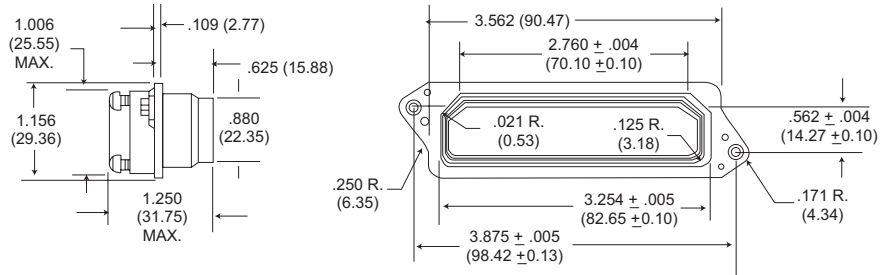

34 SHELL

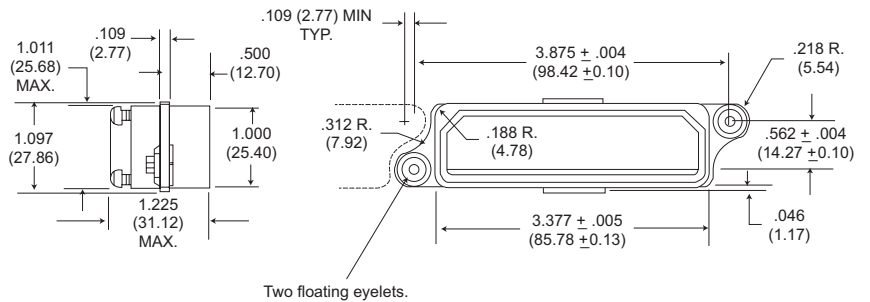

DPGM/DPJM/DPJMB

Contact Arrangements

DPGM

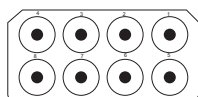

C8*
8 coax (1-8)
1000

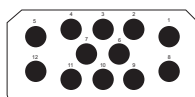

12*
12 #16 (1-12)
See note

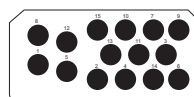

15*
15 #16 (1-15)
See note

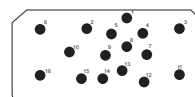

16*
5 #20 (3,6,10,11 & 16)
1500
9 #20 (1,4,5,7-9, 13-15)
1700
(2 #20 (2&12)
1500

No. of Contacts & Wire Size
Test Voltage AC (RMS)

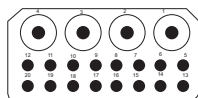

20C4*
16 #20 (5-20)
1500
4 COAX (1-4)
1000

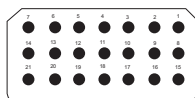

21*
21 #20 (1-21)
1500

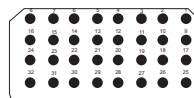

32*
32 #20 (1-32)
1500

No. of Contacts & Wire Size
Test Voltage AC (RMS)

*All DPGM arrangements have a 1500 VAC test voltage except for arrangements 12 and 15, which is 3200 VAC for contact 1,5,8 and 12. The remaining contacts have a 2200 VAC test voltage. All coaxials have 1000 VAC rms test voltage.

DPJM/DPJMB

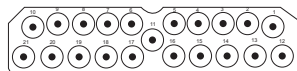

C21*
21 COAX (#1-21)
1000

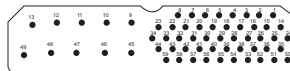

59
49 #20 (1-8,14-44 & 50-59)
1500
10 #12 (9-13 & 45-49)
1500

No. of Contacts & Wire Size
Test Voltage AC (RMS)

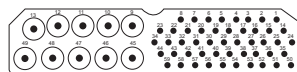

59C10*
49 #20 (1-8, 14-44&50-59)
1700
10 COAX (9-13&45-49)
1000

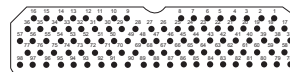

98*†
98 #20 (1-98)
1500

No. of Contacts & Wire Size
Test Voltage AC (RMS)

* All DPJM and DPJMB power contact arrangements have a 1500 VAC rms test voltage. Coaxials have 1000 VAC rms voltage.
†* Available with LITTLE CAESAR contact assembly (DPJMB).

Current Carrying Capacity of Wires and Cables	
Wire Size	Amperage
#4	80
#8	46
#12	23
#16	13
#20	7.5



Dimensions shown in inch (mm)
Specifications and dimensions subject to change

www.ittcannon.com

Junction Shells

DPGM

DPGM junction shells are essential for proper installation of connector and are ordered separately.

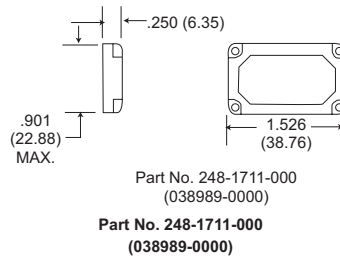

DPJM/DPJMB

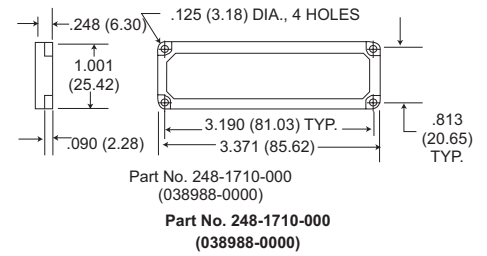

Wire Bushings

Small wires should be provided with rubber bushings before crimping. Approximately 1/16 (1.59) of an inch of bushing is visible when installed into grommet. Grommets will seal with out bushings or wire .096 (2.44) to .185 (4.70) to diameter.

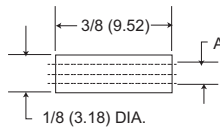

Sealing Wires on #12 and Coaxial Contacts

New Part Number	Existing Part Number	Wire Size O.D.	I.D A
012-0319-000	021604-0002	.040-.083	.062
012-0435-000	021604-0004	.080-.096	.080

Hole Fillers



All holes in grommet require filling either by a wire and contact, or by means of wire hole plugs.

Contact Size	Part Number
20	225-0070-000
16	225-0071-000
12	225-0072-000
Coaxial	225-0085-000

Contact/Coaxial Data and Termination Tool

DPJMB	Contact Size	Wire Size Accom.	Contact Part Number		Crimp Tool Part No.	Locator	Locator Color	Extraction Tool No.
			Pin	Socket				
	20	20-24	030-9081-001	031-9082-001	M22520/1-01	M22520/1-02	red	CET 20-14
	12	12-14	030-9185-002	031-9186-002	M22520/1-01	M22520/1-02	yellow	CET 12-4

DPGM/DPJM	Contact Size	Wire Size Accom.	Contact Part Number		Crimp Tool Part No.	Locator	Locator Color	Extraction Tool No.
			Pin	Socket				
	20	20-24	031-0905-000 (038820-0001)	031-0900-001 (038819-0001)	M22520/1-01	M22520/1-02	CIT 20	CET 20A
	16	16-20	031-0944-000 (040370-0000)	031-0945-000 (040371-0000)	M22520/1-01	M22520/1-02	CIT 16	CET 16
	12	12-14	031-0909-000 (038825-0000)	031-0908-000 (038826-0000)	M22520/1-01	M22520/1-02	CIT 12	CET 12
	20-18	18	031-0907-000 (038820-0000)	031-0906-000 (038819-0002)	M22520/1-01	M22520/1-02	CIT 18	CET 20A

Coaxials	Contact Size	Wire Size Accom.	Contact Part Number		Crimp Tool Part No.	Insertion Tool No.	Extraction Tool No.
			Plug	Receipt			
COAX	50 ohm (RG 196/U)	249-1178-001 (038834-0001)	249-1177-001 (038833-0001)	M22520/5-01 with Y-193 Die	CIT C2	CET C1	
COAX	75 ohm (RG 1871U)	249-1176-001 (038832-0001)	249-1175-001 (038831-0001)	WT400 995-001-071	CIT C2	CET C1	
COAX	95 ohm (RG 195/U)	249-1174-001 (038830-0001)	249-1173-001 (038829-0001)	WT402 HX3-138	CIT C2	CET C1	
COAX	150 ohm	249-1172-001 (038828-0001)	249-1171-001 (038827-0001)	WT408	CIT C2	CET C1	

Dimensions shown in inch (mm)
Specifications and dimensions subject to change



Assembly Procedures

Wiring and Crimping Contacts

Wires should be stripped to the dimension appropriate to the contact use

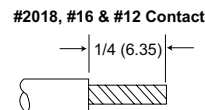
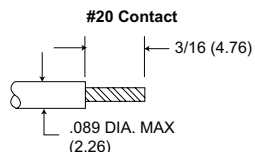

1. CONTACT INTO CRIMP TOOL

Drop contact into crimp tool, it will locate on the contact shoulder.

2. WIRE INTO CONTACT

Take wire stripped to dimensions above, and push into the contact crimp pot until it is completely home.

Where outside diameter of wire in the #12 or COAXIAL contact is less than .096 (2.44), a rubber bushing must be slipped over the wire before crimping (see page 103).

3. CRIMP

Squeeze the crimp tool to secure the wire into the contact. It is not possible to remove the contact from the crimp tool until crimp is completed.

4. REMOVED WIRED CONTACT FROM TOOL

5. INSPECT

If wires are stripped and crimped correctly, the wire will be visible through the small inspection hole in the contact.

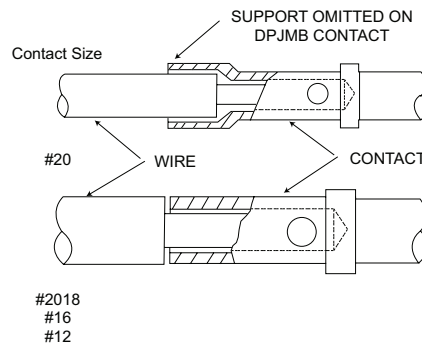

Contact Insertion (DPGM/DPJM)

Inserting #20 & #16 Contacts

Inserting Coaxial & #12 Contacts



After the contacts have been crimped, they should be threaded through the junction shell and inserted with the tools shown below. It is recommended that the contacts be inserted in the center horizontal row first, then work to the top and bottom horizontal rows.

Contact	Tool Description	Assembly Number
#20	CIT - 20	038894-0000
#16	CIT - 16	038895-0000
#12	CIT - 12	038896-0000
Coaxial 50-75,95 & 150 ohm	CIT - C2	038901-0000

Contact Extraction (DPGM/DPJM)

Extracting #20 & #16 Contacts

Extracting Coaxial & #12 Contacts



If it is necessary at any time to remove contacts, this may be accomplished with an impact extraction tool. Simply place the correct tool on the engaging end of the contact and push. A reversible tip is provided for pins and sockets.

Contact	Tool Description	Assembly Number
#20	CET - 20A	038889-0100
#16	CET - 16	038888-0000
#12	CET - 12	038890-0000
Coaxial 50-75,95 & 150 ohm	CET - C1	038869-0000

Assembly Procedures

Coaxial Contact Assembly (DPGM/DPJM)

Cable Stripping



	Cable Trim Dimensions			Cable Entry Dimensions		
	A	B	C	D min. dia.	E max. dia.	F min. dia.
150 ohm	3/16 (4.76)	1/16 (1.59)	5/32 (3.97)	.154 (3.91)	.183 (4.65)	.202 (5.13)
95 ohm	3/16 (4.76)	1/8 (3.18)	5/64 (1.98)	.106 (2.69)	.139 (3.53)	.153 (3.89)
75 ohm	3/16 (4.76)	1/8 (3.18)	5/64 (1.98)	.122 (3.10)	.158 (4.01)	
50 ohm	1/4 (6.35)	1/8 (3.18)	5/64 (1.98)	.106 (2.69)	.136 (3.53)	

50 Ohm Contact (RG-196U)
(assembly steps 1, 2, 3, 4, 5 & 8)

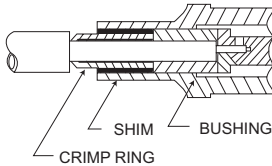

75 Ohm Contact (RG-187U)
(assembly steps 1, 2, 3, 5 & 8)

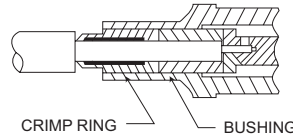

95 Ohm Contact (RG-195U)
(assembly steps 1, 3, 6, 7 & 8)

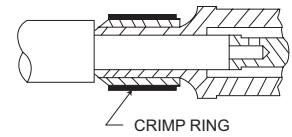

Assembly Steps

1. After the coaxial cable has been stripped to the proper dimensions, tin the center conductor. If O.D. of cable is less than .096 (2.44), slip rubber bushing over wire. (50, 75 & 95 ohm)
2. Assemble crimp ring under braid and add bushing to cable. (50 & 75 ohm)

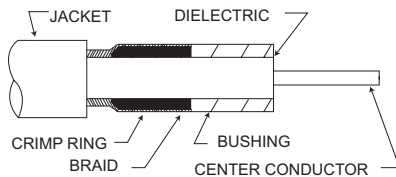

3. The center contact is supplied loose in the polyethylene bag. Insert the tinned conductor into the contact. Wire must be visible through inspection hole and dielectric pushed against contact shoulder. For 150 ohm contact shoulder must be flush against bushing. Heat contact with a clean soldering iron. Avoid solder outside contact. (50, 75, & 95 ohm)

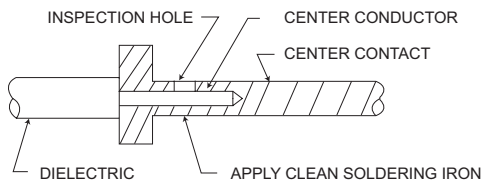

4. Wrap shim around braid. (50 ohm)

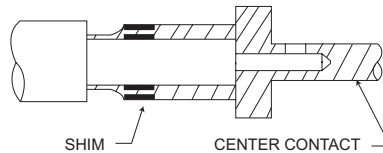

5. Feed cable and assembled parts into coaxial shell. Care is required if braid is to fit smoothly inside the shell. (50 & 75 ohm)
6. Thread crimp ring over cable. Feed center contact into coaxial shell with the shell between the dielectric and the braid. (95 ohm)

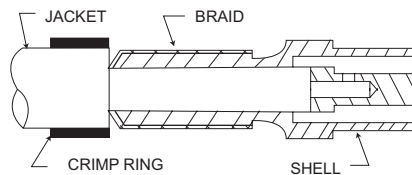

7. Slip crimp over the braid. (95 ohm)
8. Crimp - crimp tool must be located 1/16 (1.58) to 5/64 (1.98) from shoulder of coaxial. (50, 75 & 95 ohms)

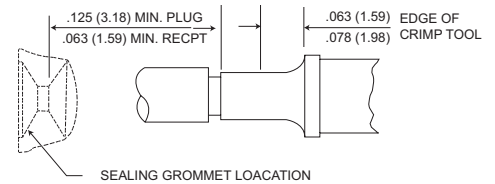

DPGM/DPJM/DPJMB

Junction Shell, Assembly of



Slip junction shell over grommet and secure with four screws and lock washers.

Panel Cutouts

33 and 34 Shell Styles

DPGM

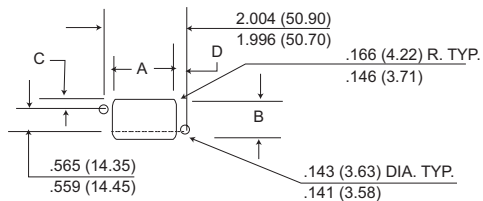

DPJM DPJMB

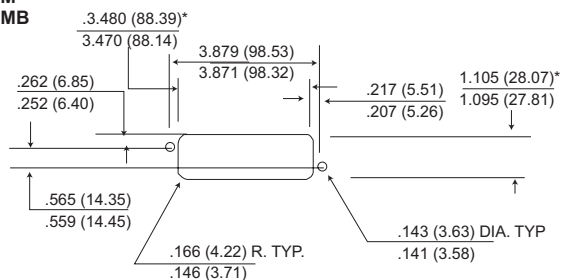

*These dimensions allow for float mounting.

	A	B	C	D	Gap Between Flanges after mating
DPGM-33	1.609(40.87)	.985(25.02)	.214(5.44)	.203(5.16)	.500(12.70) .625(15.88)
	1.599(40.61)	.975(24.76)	.204(5.18)	.193(4.90)	
DPG-34	1.636(41.55)	1.011(25.68)	.227(5.76)	.190(4.83)	.500(12.70) .625(15.88)
	1.626(41.30)	1.001(25.42)	.217(5.51)	.180(4.57)	

PANEL THICKNESS: Maximum sum of both panel thicknesses is 7/16 of an inch when 33 plug and 34 receptacle are back mounted. Shell style 33 modifications A and -2 can be back mounted ONLY. Shell style 33 modifications B and shell style 34 modifications B and H may be front or back mounted. Consult factory for additional information.

Mounting Variations

33 Shell



34 Shell

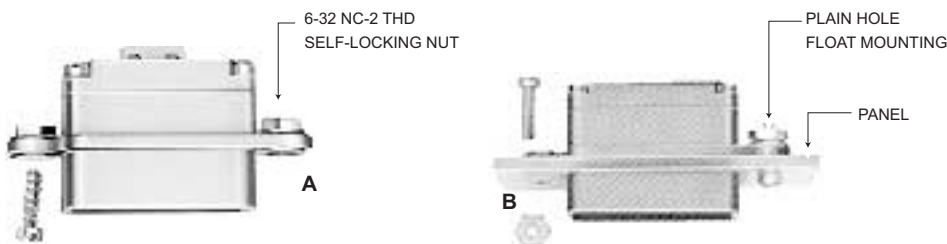

Dimensions shown in inch (mm)
Specifications and dimensions subject to change

www.ittcannon.com