



# PM-148/PM-248

QUAD 741

OPERATIONAL AMPLIFIERS

Precision Monolithics Inc.

## FEATURES

Improved Specifications Over Industry Standard LM148

- Input Offset Voltage ..... 2.5mV Max
- Input Offset Current ..... 10nA Max
- Input Bias Current ..... 75nA Max
- Small Signal Bandwidth ..... 0.8MHz Typ
- Common-Mode Rejection Ratio ..... 105dB Typ
- Power Supply Rejection Ratio ..... 115dB Typ
- Phase Margin ..... 80° Typ
- Available in Die Form

Fully Specified Over Military and Industrial Temperature Range

## PIN CONNECTIONS

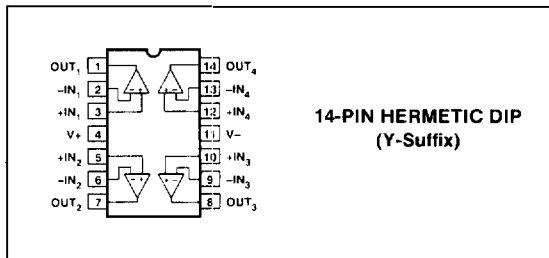

## ORDERING INFORMATION†

V <sub>OS</sub> MAX (mV)	PACKAGE	OPERATING TEMPERATURE RANGE
2.5	PM-148Y	MIL
2.5	PM-248Y	IND

† Burn-in is available on commercial and industrial temperature range parts in CerDIP, plastic DIP, and TO-can packages. For ordering information, see PMI's Data Book, Section 2.

## GENERAL DESCRIPTION

The PM-148 is Precision Monolithics' improved version of the industry-standard LM148 quad 741, high gain, internally compensated, low-power operational amplifier, offered over the full military and industrial temperature ranges. The PM-148 provides functional characteristics identical to the LM148 and is a pin-for-pin replacement with significant improvements on the key parameters of input offset voltage, input bias current, and input offset current.

## SIMPLIFIED SCHEMATIC (One of Four Amplifiers)

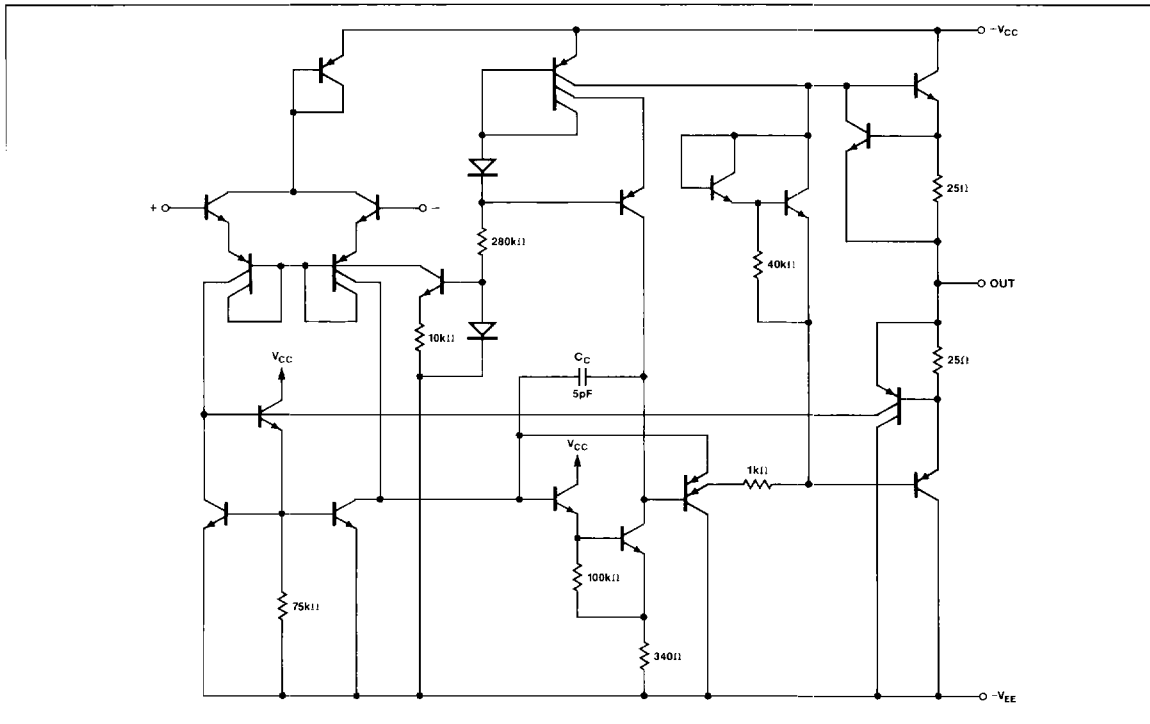

Excellent isolation between amplifiers is achieved by independently biasing each amplifier and using layout techniques that minimize thermal coupling.

The PM-148 can be used anywhere multiple 741 or 1558 type amplifiers are being used and in applications where amplifier matching or high packing density is required. The improved performance of the PM-148 allows immediate upgrading of LM148 applications.

### ABSOLUTE MAXIMUM RATINGS

Supply Voltage .....	±22V
Differential Input Voltage .....	±44V
Input Voltage .....	±22V
Output Short Circuit Duration (Note 1) .....	Continuous

Maximum Junction Temperature .....	+150°C
Operating Temperature Range	
PM-148 .....	-55°C ≤ T <sub>A</sub> ≤ +125°C
PM-248 .....	-25°C ≤ T <sub>A</sub> +85°C
Storage Temperature Range .....	-65°C to +150°C
Lead Temperature Range .....	+300°C

PACKAGE TYPE	θ <sub>JA</sub> (Note 2)	θ <sub>JC</sub>	UNITS
14-Pin Hermetic DIP (Y)	108	16	°C/W

#### NOTES:

- Any of the amplifier outputs can be shorted to ground indefinitely; however, more than one should not be simultaneously shorted as the maximum junction temperature will be exceeded.
- θ<sub>JA</sub> is specified for worst case mounting conditions, i.e., θ<sub>JA</sub> is specified for device in socket for CerDIP package.

### ELECTRICAL CHARACTERISTICS at V<sub>S</sub> = ±15V, T<sub>A</sub> = 25°C, unless otherwise noted.

PARAMETER	SYMBOL	CONDITIONS	PM-148/PM-248			UNITS
			MIN	TYP	MAX	
Input Offset Voltage	V <sub>OS</sub>	R <sub>S</sub> ≤ 10kΩ	—	0.1	2.5	mV
Input Offset Current	I <sub>OS</sub>		—	0.1	10	nA
Input Bias Current	I <sub>B</sub>		—	20	75	nA
Input Resistance	R <sub>IN</sub>	(Note 1)	0.8	2.5	—	MΩ
Supply Current	I <sub>SY</sub>	V <sub>S</sub> = ±15V	—	2.4	3.6	mA
Large Signal Voltage Gain	A <sub>VO</sub>	V <sub>S</sub> = ±15V V <sub>OUT</sub> = ±10V, R <sub>L</sub> = 2kΩ	50	150	—	V/mV
Positive Short Circuit Current	I <sub>SC+</sub>		—	18	—	mA
Negative Short Circuit Current	I <sub>SC-</sub>		—	36	—	mA
Common-Mode Rejection Ratio	CMRR	R <sub>S</sub> ≤ 10kΩ	80	105	—	dB
Input Voltage Range	IVR	V <sub>S</sub> = ±15V	±12	—	—	V
Power Supply Rejection Ratio	PSRR	R <sub>S</sub> ≤ 10kΩ	85	115	—	dB
Output Voltage Swing	V <sub>O</sub>	V <sub>S</sub> = ±15V R <sub>L</sub> = 10kΩ R <sub>L</sub> = 2kΩ	±12 ±11	±13 ±12.5	—	V
Slew Rate	SR	A <sub>V</sub> = 1	—	0.4	—	V/μs
Small Signal Bandwidth	BW		—	0.8	—	MHz
Phase Margin	0°	A <sub>V</sub> = 1	—	80	—	degrees

#### NOTE:

- Guaranteed by formula  $R_{IN} = \frac{4KT}{qI_B}$ .

**ELECTRICAL CHARACTERISTICS** at  $V_S = \pm 15V$ ,  $-55^\circ C \leq T_A \leq +125^\circ C$ , unless otherwise noted.

PARAMETER	SYMBOL	CONDITIONS	PM-148			UNITS
			MIN	TYP	MAX	
Input Offset Voltage	$V_{OS}$	$R_S \leq 10k\Omega$	—	0.6	6	mV
Input Offset Current	$I_{OS}$		—	0.5	25	nA
Input Bias Current	$I_B$		—	30	100	nA
Supply Current	$I_{SY}$	$V_S = \pm 15V$ $T_A \leq +125^\circ C$ $T_A \geq -55^\circ C$	—	2.4	3.6	mA
			—	3.5	4.5	
Large Signal Voltage Gain	$A_{VO}$	$V_S = \pm 15V$ $V_{OUT} \pm 10V, R_L \geq 2k\Omega$	25	75	—	V/mV
Common-Mode Rejection Ratio	CMRR	$R_S \leq 10k\Omega$	80	100	—	dB
Power Supply Rejection Ratio	PSRR		80	95	—	dB
Output Voltage Swing	$V_O$	$V_S = \pm 15V$ $R_L = 10k\Omega$ $R_L = 2k\Omega$	$\pm 12$ $\pm 10$	$\pm 13$ $\pm 12$	—	V
Input Voltage Range	IVR	$V_S = \pm 15V$	$\pm 12$	—	—	V

**ELECTRICAL CHARACTERISTICS** at  $V_S = \pm 15V$ ,  $-25^\circ C \leq T_A \leq +85^\circ C$ , unless otherwise noted.

PARAMETER	SYMBOL	CONDITIONS	PM-248			UNITS
			MIN	TYP	MAX	
Input Offset Voltage	$V_{OS}$	$R_S \leq 10k\Omega$	—	—	7.5	mV
Input Offset Current	$I_{OS}$		—	—	125	nA
Input Bias Current	$I_B$		—	—	500	nA
Supply Current	$I_{SY}$	$V_S = \pm 15V$	—	2.4	4.5	mA
Large Signal Voltage Gain	$A_{VO}$	$V_S = \pm 15V$ $V_{OUT} \pm 10V, R_L \leq 2k\Omega$	15	—	—	V/mV
Common-Mode Rejection Ratio	CMRR	$R_S \leq 10k\Omega$	70	90	—	dB
Power Supply Rejection Ratio	PSRR	$R_S \leq 10k\Omega$	77	96	—	dB
Output Voltage Swing	$V_O$	$V_S = \pm 15V$ $R_L = 10k\Omega$ $R_L = 2k\Omega$	$\pm 12$ $\pm 10$	$\pm 13$ $\pm 12$	—	V
Input Voltage Range	IVR	$V_S = \pm 15V$	$\pm 12$	—	—	V

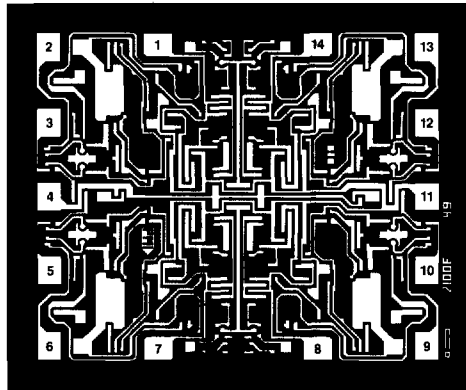
**DICE CHARACTERISTICS**

**DIE SIZE 0.064 × 0.075 inch, 4800 sq. mils**  
 (1.62 × 1.90 mm, 3.08 sq. mm)

1. OUT 1
2. IN 1
3. IN 1-
4. V+
5. IN 2-
6. IN 2
7. OUT 2
8. OUT 3
9. IN 3
10. IN 3+
11. V-
12. IN 4+
13. IN 4
14. OUT 4

For additional DICE ordering information,  
 refer to PMI's Data Book, Section 2.

**WAFER TEST LIMITS** at  $V_S = \pm 15V$ ,  $T_A = 25^\circ C$  for PM-148GBC,  $T_A = 125^\circ C$  for PM-148GTBC, unless otherwise noted.

PARAMETER	SYMBOL	CONDITIONS	LIMIT		UNITS
			PM-148GBC	PM-148GTBC	
Input Offset Voltage	$V_{OS}$	$R_S = 10k\Omega$	2.5	6.0	mV MAX
Input Offset Current	$I_{OS}$		10	25	nA MAX
Input Bias Current	$I_B$		75	100	nA MAX
Supply Current	$I_{SY}$	$V_S = \pm 15V$	3.6	3.6	mA MAX
Large Signal Voltage Gain	$A_{VO}$	$V_S = +15V$ $V_{OUT} = +10V, R_L = 2k\Omega$	50	25	V mV MIN
Common-Mode Rejection Ratio	CMRR	$R_S = 10k\Omega$	80	80	dB MIN
Power Supply Rejection Ratio	PSRR	$R_S = 10k\Omega$	85	80	dB MIN
Output Voltage Swing	$V_O$	$V_S = \pm 15V, R_L = 10k\Omega$ $R_L = 2k\Omega$	+12 -11	+12 -10	V MIN
Input Voltage Range	IVR	$V_S = \pm 15V$	+12	+12	V MIN

**NOTE:**

Electrical tests are performed at wafer probe to the limits shown. Due to variations in assembly methods and normal yield loss, yield after packaging is not guaranteed for standard product dice. Consult factory to negotiate specifications based on dice lot qualification through sample lot assembly and testing.

## TYPICAL PERFORMANCE CHARACTERISTICS

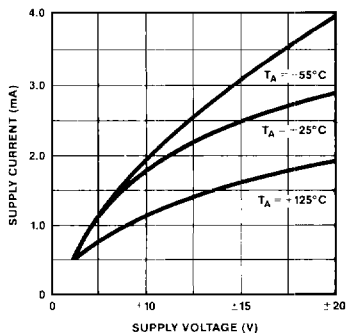
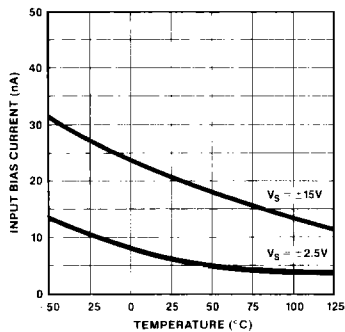
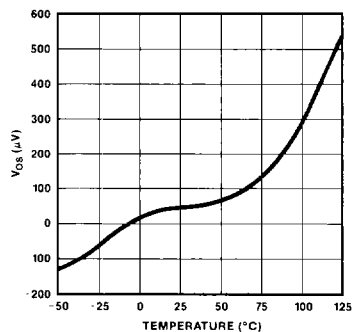
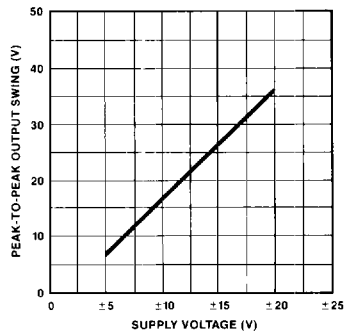
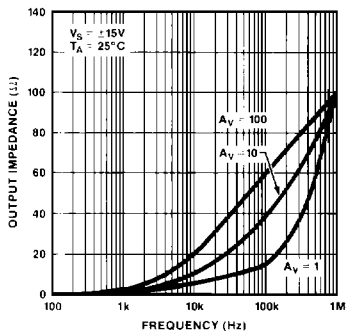
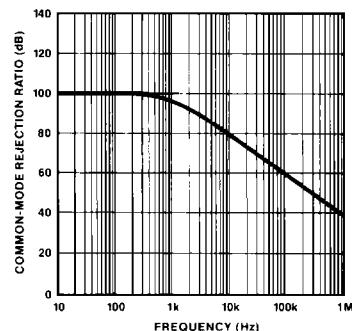
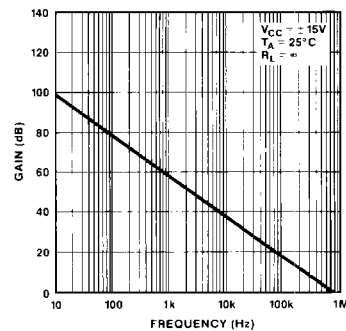
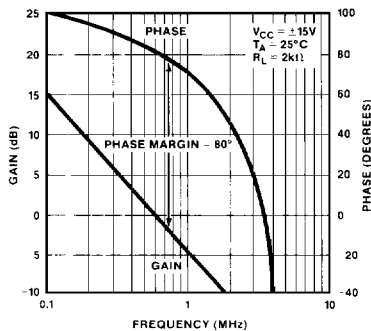
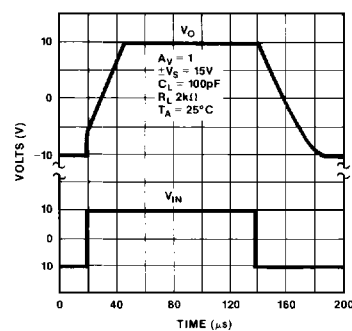
**SUPPLY CURRENT vs SUPPLY VOLTAGE**

**INPUT BIAS CURRENT vs TEMPERATURE**

**INPUT OFFSET VOLTAGE vs TEMPERATURE**

**VOLTAGE SWING vs SUPPLY VOLTAGE**

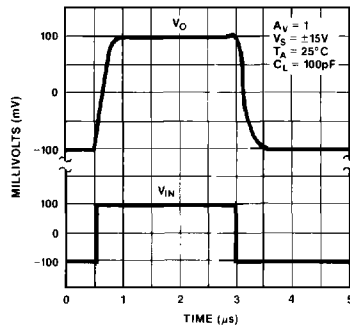
**OUTPUT IMPEDANCE vs FREQUENCY**

**COMMON-MODE REJECTION RATIO vs FREQUENCY**

**OPEN-LOOP FREQUENCY RESPONSE vs GAIN**

**GAIN AND PHASE vs FREQUENCY**

**LARGE SIGNAL PULSE RESPONSE**

OPERATIONAL AMPLIFIERS/BUFFERS

## TYPICAL PERFORMANCE CHARACTERISTICS

SMALL SIGNAL PULSE RESPONSE



SLEW RATE vs TEMPERATURE

