



Features

- Compliant with IEEE 802.3ah, 1000Base-BX10
- Simplex SC Connector
- Single 3.3V Supply
- 13 dB Minimum Power Budget
- 20 km Minimum Reach
- 1310nm FP Laser
- Commercial Temperature Available
- Industrial Temperature Available
- Digital Diagnostic SFF-8472 Compliant
- SFP MSA SFF-8074i Compliant
- Telcordia GR-468 Compliant
- Color Coded Bail Latch Tube: Blue
- RoHS Compliant

Table 1 – General Operating

Parameter	Symbol	Min.	Typical	Max.	Unit	Notes
Supply Voltage	Vcc	3.135	3.3	3.465	V	
Total Current		-	-	300	mA	
Power Supply Noise Rejection	PSR	100	-	-	mVp-p	
Operating Temperature (Case)	T _{opr}	-5	-	70	°C	1
Operating Temperature (Case)	T _{opr}	-40	-	85	°C	
Storage Temperature	T _{stg}	-40	-	85	°C	
Data Rate	DR	-	1250	-	Mbps	

Note 1: Please refer to order information

Table 2 – Transmitter Specifications (Optical)

Parameter	Symbol	Min.	Typical	Max.	Unit	Notes
Optical Power	P _{op}	-7	-4	0	dBm	
Optical Crosstalk	XT	-	-45	-40	dB	
Average Launch Power Tx_Off	P _{off}	-	-	-45	dBm	
Extinction Ratio	ER	6	-	-	dB	
Eye Mask		IEEE 802.3ah Compliant				
Optical Rise/Fall Time (20%~80% values)	t _r /t _f	-	-	260	ps	
Mean Wavelength	λ	1260	1310	1360	nm	
Spectral Width (RMS)	Δλ	-	-	3.5	nm	
Relative Intensity Noise	RIN	-	-	-120	dB/Hz	
Transmitter Reflectance	-	-	-	-12	dB	
Reflection Tolerance	rp	-	-	12	dB	

Table 3 – Transmitter Specifications (Electrical)

Parameter	Symbol	Min.	Typical	Max.	Unit	Notes
Input Differential Impedance	R_{in}	80	100	120	Ω	
PECL Single Ended Data Input Swing	$V_{in, p-p}$	250	-	1200	mV	
TxFault_Fault	V_{fault}	2	-	Vcc	V	
TxFault_Normal	V_{normal}	Vee	-	Vee + 0.5	V	
TxDisable_Disable	V_d	2	-	Vcc	V	
TxDisable_Enable	V_{en}	Vee	-	Vee + 0.8	V	

Table 4 – Receiver Specifications (Optical)

Parameter	Symbol	Min.	Typical	Max.	Unit	Notes
Receiver Power Low	$R_{sens,low}$	-	-22	-20	dBm	2
Receiver Power High	$R_{sens,high}$	-3	-	-	dBm	2
Damage Threshold For Receiver	$P_{in, damage}$	0	-	-	dBm	
Wavelength	λ	1480	-	1580	nm	3
Receiver Reflectance	RX_r	-	-	-12	dB	
LOS Assert	-	-45	-	-	dBm	
LOS De-Assert	-	-	-	-20	dBm	
LOS Hysteresis	-	0.5	-	-	dB	

Note 2: Measured at 10^{-12} BER, PRBS 2^7-1 , 6dB ER

Note 3: Receiver performance can be maintained over a broader wavelength range of 1480 nm to 1580 nm

Table 5 – Receiver Specifications (Electrical)

Parameter	Symbol	Min.	Typical	Max.	Unit	Notes
PECL Single Ended Data Output Swing	$V_{out,p-p}$	185	-	800	mV	
Data Output Rise/Fall Time	t_r/t_f	-	-	260	ps	

Table 6 – Timing and Electrical

Parameter	Symbol	Min.	Typical	Max.	Unit	Notes
Tx Disable Negate Time	t_on	-	-	1	ms	
Tx Disable Assert Time	t_off	-	-	10	µs	
Time to Initialize, Including Reset of Tx Fault	t_init	-	-	300	ms	
Tx Fault Assert Time	t_fault	-	-	100	µs	
Tx Disable to Reset	t_reset	10	-	-	µs	
LOS Assert Time	t_loss_on	-	-	100	µs	
LOS De-Assert Time	t_loss_off	-	-	100	µs	
Serial ID Clock Rate	f_serial_clock	-	-	100	kHz	
RX_LOS Voltage (High)	Rx_LOS _H	2	-	-	V	
RX_LOS Voltage (Low)	Rx_LOS _L	-	-	0.8	V	
LOS Output Voltage-Fault	V _{LOS} fault	2	-	V _{cc}	V	
LOS Output Voltage-Normal	V _{LOS} normal	V _{ee}	-	V _{ee} + 0.5	V	
MOD_DEF (0:2)-High	V _H	2	-	V _{cc}	V	
MOD_DEF (0:2)-Low	V _L	V _{ee}	-	V _{ee} + 0.5	V	

Table 7 – Diagnostics

Parameter	Range	Accuracy	Unit	Calibration	Formula
Temperature (-CDC)	-5 to 70	±3	°C	External	Tc(C) = Tslope*Tad(16 bit signed twos complement value) + Toffset
Temperature (-TDC)	-40 to 85	±3	°C	External	Tc(C) = Tslope*Tad(16 bit signed twos complement value) + Toffset
Voltage	0 to V _{cc}	0.1	V	External	V(Volts) = Vslope*Vad (16 bit unsigned integer) + Voffset
Bias Current	0 to 120	5	mA	External	I(mA) = Islope * Iad(16 bit unsigned integer) + Ioffset
Tx Power	-7 to 0	±3	dBm	External	Tx_PWR(µW) = Tx_PWRslope*Tx_PWRad (16 bit unsigned integer)+Tx_PWRoffset
Rx Power	-20 to -3	±3	dBm	External	Rx_PWR(µW) = A0+A1*x+A2*x^2+A3*x^3+A4*x^4

Table 8 – EEPROM Serial ID (A0h)

Name of Field	Description of Field	Address	Hex	ASCII
Identifier	Type of serial transceiver	0	03	
Ext. Identifier	Extended identifier of type of serial transceiver	1	04	
Connector	Code for connector type	2	01	
Transceiver	Code for electronic compatibility or optical compatibility	3	00	
		4	00	
		5	00	
		6	40	
		7	00	
		8	00	
		9	00	
		10	00	
Encoding	Code for serial encoding algorithm	11	01	
BR.Nominal	Units of 100 MBits/sec.	12	0D	
Reserved	Reserved	13	00	
Length (9µm,km)	9/125 µm fiber, units of km	14	14	
Length (9µm)	9/125 µm fiber, units of 100 m	15	C8	
Length (50µm)	50/125 µm fiber, units of 10 m	16	00	
Length (62.5µm)	62.5/125 µm fiber, units of 10 m	17	00	
Length (Copper)	Units of meters	18	00	
Reserved	Reserved	19	00	
Vendor Name	SFP vendor name (ASCII)	20	53	S
		21	4F	O
		22	55	U
		23	52	R
		24	43	C
		25	45	E
		26	50	P
		27	48	H
		28	4F	O
		29	54	T
		30	4F	O
		31	4E	N
		32	49	I
		33	43	C
		34	53	S
		35	20	[Space]

Table 8 – EEPROM Serial ID (A0h)

Name of Field	Description of Field	Address	Hex	ASCII
Reserved	Reserved	36	00	
Vendor OUI	SFP vendor IEEE company ID for Source Photonics Inc.	37	00	
		38	1F	
		39	22	
Vendor P/N	Part number in ASCII, e.g. SPS34GBEBXCDC	40	53	S
		41	50	P
		42	53	S
		43	33	3
		44	34	4
		45	47	G
		46	42	B
		47	45	E
		48	42	B
		49	58	X
		50	43	C
		51	44	D
		52	43	C
		53	20	[Space]
54	20	[Space]		
55	20	[Space]		
Vendor Rev.	Revision level for part number provide by vendor (ASCII)	56	41	A
		57	20	[Space]
		58	20	[Space]
		59	20	[Space]
Wavelength	1310nm	60	05	
		61	1E	
Reserved	Reserved	62	00	
CC_BASE	Check code for Base ID Fields (addresses 0 to 62)	63	xx	
Options	Indicates which optional transceiver signals are implemented	64	00	
		65	1A	

Table 8 – EEPROM Serial ID (A0h)

Name of Field	Description of Field	Address	Hex	ASCII
BR, max	Upper bit rate margin, unit of %	66	00	
BR, min	Lower bit rate margin, unit of %	67	00	
Vendor S/N	Serial number	68-83	xx	
Date Code	Vendor's manufacturing date code	84-91	xx	
Diagnostic Monitoring Type	Indicates which type of diagnostic monitoring is implemented in the transceiver	92	58	
Enhanced Options	Indicates which optional enhanced features are implemented in the transceiver	93	B0	
SFF-8472 Compliance	Indicates which revision of SFF-8472 the transceiver complies with	94	02	
CC_EXT	Check code for Extended ID Fields (addresses 64 to 94)	95	xx	
Vendor Specific	Vendor Specific EEPROM	96-127	xx	

Table 9 – Pin Definitions

Pin	Unit	Notes
1	VeeT	TX GND
2	TX_FAULT	Open Collector
3	TX_DISABLE	Internally Pulled High
4	MOD_DEF2	Serial Data Input
5	MOD_DEF1	Serial Clock Input
6	MOD_DEF0	Internally Grounded
7	NC	Not Connected
8	LOS	Open Collector
9	VeeR	RX Ground
10	VeeR	RX Ground
11	VeeR	RX Ground
12	RXD-	RX Data Negative
13	RXD+	RX Data Positive
14	VeeR	RX GND
15	VCCR	RX Power
16	VCCT	TX Power
17	VeeT	TX GND
18	TXD+	TX Data Positive
19	TXD-	TX Data Negative
20	VeeT	TX GND

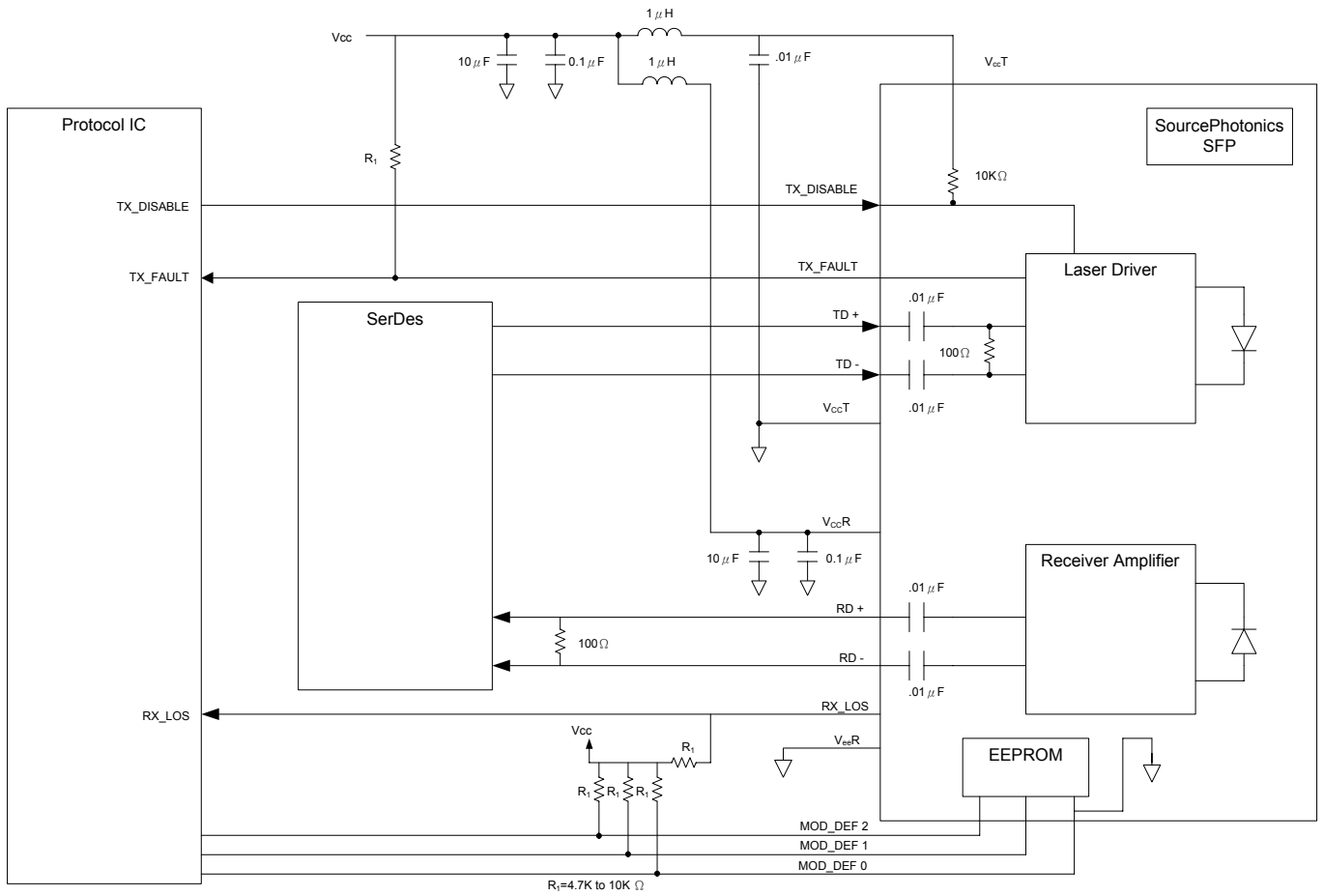
Recommended Interface Circuit

Mechanical Diagram

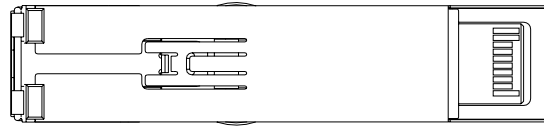
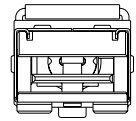
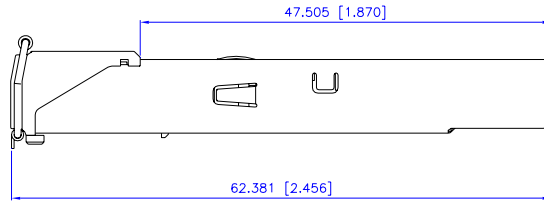
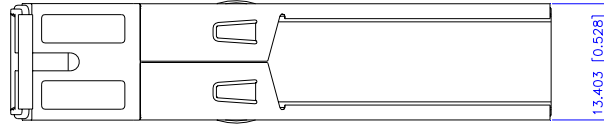
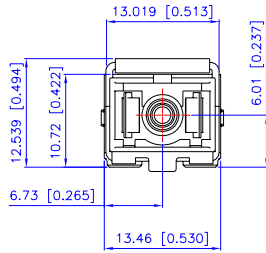

Units in mm(inch)

Order Information

Table 10 – Order Information

Part No.	
SPS-34-GB-EBX-CDC	SPS-34-GB-EBX-CNC
SPS-34-GB-EBX-TDC	SPS-34-GB-EBX-TNC

Part Numbering Definition:

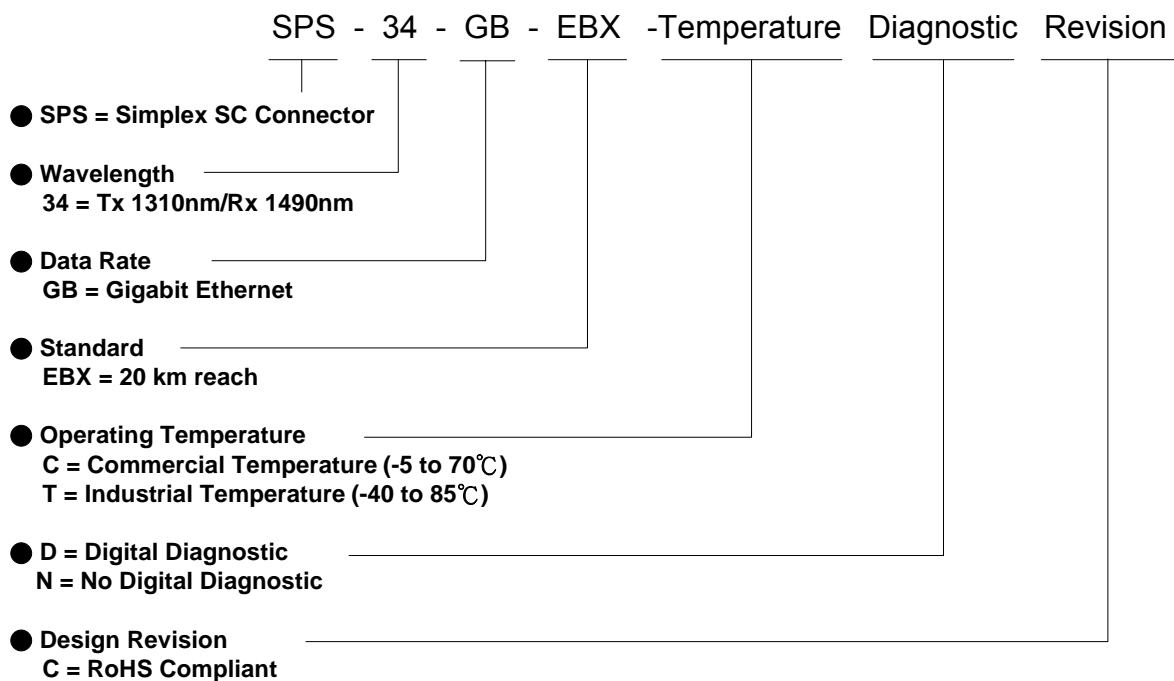

Warnings

Handling Precautions: This device is susceptible to damage as a result of electrostatic discharge (ESD). A static free environment is highly recommended. Follow guidelines according to proper ESD procedures.

Laser Safety: Radiation emitted by laser devices can be dangerous to human eyes. Avoid eye exposure to direct or indirect radiation.

Legal Notice

IMPORTANT NOTICE!

All information contained in this document is subject to change without notice, at Source Photonics' sole and absolute discretion. Source Photonics warrants performance of its products to current specifications only in accordance with the company's standard one-year warranty; however, specifications designated as "preliminary" are given to describe components only, and Source Photonics expressly disclaims any and all warranties for said products, including express, implied, and statutory warranties, warranties of merchantability, fitness for a particular purpose, and non-infringement of proprietary rights. Please refer to the company's Terms and Conditions of Sale for further warranty information.

Source Photonics assumes no liability for applications assistance, customer product design, software performance, or infringement of patents, services, or intellectual property described herein. No license, either express or implied, is granted under any patent right, copyright, or intellectual property right, and Source Photonics makes no representations or warranties that the product(s) described herein are free from patent, copyright, or intellectual property rights. Products described in this document are NOT intended for use in implantation or other life support applications where malfunction may result in injury or death to persons. Source Photonics customers using or selling products for use in such applications do so at their own risk and agree to fully defend and indemnify Source Photonics for any damages resulting from such use or sale.

THE INFORMATION CONTAINED IN THIS DOCUMENT IS PROVIDED ON AN "AS IS" BASIS. Customer agrees that Source Photonics is not liable for any actual, consequential, exemplary, or other damages arising directly or indirectly from any use of the information contained in this document. Customer must contact Source Photonics to obtain the latest version of this publication to verify, before placing any order, that the information contained herein is current.

Contact

U.S.A. Headquarters

20550 Nordhoff Street
Chatsworth, CA 91311
USA

Tel: +1-818-773-9044

Fax: +1-818-773-0261

sales@sourcephotonics.com

China

Building #2&5, West Export Processing Zone
No. 8 Kexin Road, Hi-Tech Zone
Chengdu, 611731, China

Tel: +86-28-8795-8788

Fax: +86-28-8795-8789

sales@sourcephotonics.com.cn

Taiwan

9F, No 81, Shui Lee Rd.
Hsinchu, 300, Taiwan
R.O.C.

Tel: +886-3-5169222

Fax: +886-3-5169213

sales@sourcephotonics.com.tw

© Copyright Source Photonics, Inc. 2007~2008

All rights reserved