

## FEATURES

- RoHS compliant
- Industry standard eighth-brick pinout and package
- Outputs from 1.5V to 12V up to 100W
- Low profile 0.4" height with 0.9" x 2.3" outline dimensions
- 36 to 75 Vdc input range (48V nominal)
- Fully isolated, 2250 Vdc (BASIC) insulation
- Outstanding thermal performance and derating
- Extensive self-protection and short circuit features with no output reverse conduction
- On/Off control, trim and sense functions
- Interleaved synchronous rectification yields high efficiency over 90%
- Fully protected against temperature and voltage limits
- Designed to meet UL/EN/IEC 60950-1 and CAN/CSA C22.2 No. 60950-1 safety approvals

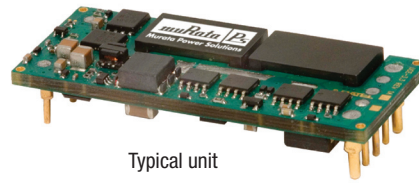

Typical unit

For efficient, fully isolated DC power in the smallest space, the UCE open frame DC/DC converter series fit in industry-standard “eighth brick” outline dimensions and mounting pins (on quarter-brick pinout).

## PRODUCT OVERVIEW

Units are offered with fixed output voltages from 1.5 to 12 Volts and currents up to 40 Amps. UCes operate over a wide temperature range (up to +85 degrees Celsius at moderate airflow) with full rated power. Interleaved synchronous rectifier topology yields excellent efficiency over 90% and no reverse output conduction.

UCes achieve these impressive mechanical and environmental specs while delivering excellent electrical performance in a through-hole package. Overall noise is typically 50 mV pk-pk (low voltage models) with fast step response. These converters offer tight output regulation and high stability even with no load. The unit is fully protected against input undervoltage, output overcurrent and short circuit. An on-board temperature sensor shuts

down the converter if thermal limits are reached. “Hiccup” output protection automatically restarts the converter when the fault is removed.

A convenient remote On/Off control input enables phased startup and shutdown in multi-voltage applications. To compensate for longer wiring and to retain output voltage accuracy at the load, UCes employ a Sense input to dynamically correct for ohmic losses. A trim input may be connected to a user’s adjustment potentiometer or trim resistors for output voltage calibration. The UCE will tolerate substantial capacitive loading for bypass-cap applications.

UCes include industry-standard safety certifications and BASIC I/O insulation provides input/output isolation to 2250V. Radiation emission testing is performed to widely-accepted EMC standards.

## SIMPLIFIED BLOCK DIAGRAM

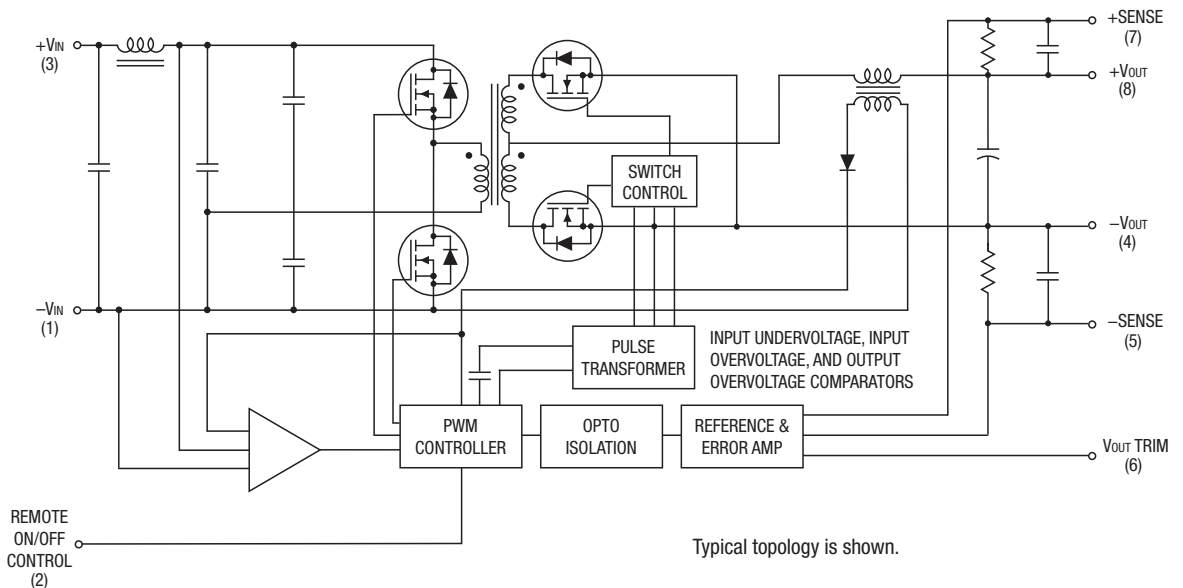

**25**  
For full details go to  
[www.murata-ps.com/rohs](http://www.murata-ps.com/rohs)

| PERFORMANCE SPECIFICATIONS AND ORDERING GUIDE |                      |                      |           |  |      |            |        |                          |           |                                |                                 |      |         |      |        |
|---|----------------------|----------------------|-----------|--|------|------------|--------|--------------------------|-----------|--------------------------------|---------------------------------|------|---------|------|--------|
| Model Family                                  | Output               |                      |           |  |      |            | Input  |                          |           |                                | Efficiency                      |      | Package |      |        |
|   | V <sub>OUT</sub> (V) | I <sub>OUT</sub> (A) | Power (W) | Ripple & Noise (mVp-p)   |      | Regulation |        | V <sub>IN</sub> Nom. (V) | Range (V) | I <sub>IN</sub> , no load (mA) | I <sub>IN</sub> , full load (A) | Min. | Typ.    | Case | Pinout |
|   |                      |                      |           | Typ.   | Max. | Line       | Load   |                          |           |                                |                                 |      |         |      |        |
| UCE-1.2/40-D48N-C                             | 1.2                  | 40                   | 48        | Please contact Murata Power Solutions for further information. |      |            |        |                          |           |                                |                                 |      |         |      |        |
| UCE-1.5/20-D48N-C                             | 1.5                  | 20                   | 30        | 50   | 100  | ±0.15%     | ±0.3%  | 48                       | 36-75     | 50                             | 0.72                            | 85%  | 87%     | C56  | P32    |
| UCE-1.5/40-D48N-C                             | 1.5                  | 40                   | 60        | Please contact Murata Power Solutions for further information. |      |            |        |                          |           |                                |                                 |      |         |      |        |
| UCE-1.8/30-D48N-C                             | 1.8                  | 30                   | 54        | 30   | 80   | ±0.125%    | ±0.25% | 48                       | 36-75     | 45                             | 1.28                            | 87%  | 88%     | C56  | P32    |
| UCE-2.5/20-D48N-C                             | 2.5                  | 20                   | 50        | 50   | 80   | ±0.125%    | ±0.25% |                          |           | 50                             | 1.14                            | 88%  | 91%     |      |        |
| UCE-2.5/40-D48N-C                             | 2.5                  | 40                   | 100       | Please contact Murata Power Solutions for further information. |      |            |        |                          |           |                                |                                 |      |         |      |        |
| UCE-3.3/15-D48N-C                             | 3.3                  | 15                   | 49.5      | 50   | 100  | ±0.125%    | ±0.25% | 48                       | 36-75     | 60                             | 1.15                            | 86%  | 90%     | C56  | P32    |
| UCE-3.3/30-D48N-C                             | 3.3                  | 30                   | 99        |  |      | ±0.1%      | ±0.2%  |                          |           |                                | 2.27                            | 89%  | 91%     |      |        |
| UCE-5/10-D48N-C                               | 5                    | 10                   | 50        | 50   | 100  | ±0.125%    | ±0.25% | 48                       | 36-75     | 30                             | 1.15                            | 88%  | 90.5%   | C56  | P32    |
| UCE-5/20-D48N-C                               | 5                    | 20                   | 100       | Please contact Murata Power Solutions for further information. |      |            |        |                          |           |                                |                                 |      |         |      |        |
| UCE-12/4.2-D48N-C                             | 12                   | 4.2                  | 50.4      | 150  | 300  | ±0.125%    | ±0.25% | 48                       | 36-75     | 50                             | 1.14                            | 86%  | 92%     | C56  | P32    |
| UCE-12/8.3-D48N-C                             | 12                   | 8.3                  | 99.6      | 200  |      |            |        |                          |           |                                | 2.31                            |      | 90%     |      |        |

① Please refer to the model number structure for additional ordering part numbers and options .

### PART NUMBER STRUCTURE

**U CE - 3.3 / 30 - D48 N B H - C**

- Output Configuration:** U = Unipolar/Single
- Eighth-Brick Package**
- Nominal Output Voltage**
- Maximum Rated Output**  
Current in Amps
- Input Voltage Range:**  
D48 = 36-75V, 48V nominal
- RoHS Hazardous Materials compliance**  
C = RoHS-6 (no lead), standard  
Y = RoHS-5 (with lead), optional, special quantity order
- Conformal coating (optional)**  
Blank = no coating, standard  
H = Coating added, optional, special quantity order
- Baseplate (optional, not available on some models)**  
Blank = No baseplate, standard  
B = Baseplate installed, optional, special quantity order
- On/Off Control Polarity**  
N = Negative polarity, standard  
P = Positive polarity, optional

**Note: Some model combinations may not be available. Contact Murata Power Solutions for availability.**

## SPECIFICATIONS

| INPUT CHARACTERISTICS         |                                 |  |   |                                      |   |                           |  |   |  |                                    |  |  |   |      |     |
|-------------------------------|---------------------------------|--|---|--------------------------------------|---|---------------------------|--|---|--|------------------------------------|--|--|---|------|-----|
| Model Family                  | V <sub>IN</sub> (Volts) nominal | Start-up threshold Min. (A)                              | Under-voltage Shut-down (V)                                   | Reflected (back) Ripple Current (mA) | Inrush Transient A <sup>2</sup> sec     | Output Short Circuit (mA) | Low Line (V <sub>IN</sub> =min.) (A)                               | Standby Mode (mA)   | Internal Input Filter Type                       | Reverse Polarity Protection        | Remote On/Off Control  |  |   |      |     |
|                               |                                 |  |   |                                      |   |                           |  |   |  |                                    | Current (mA)   | Positive Logic "P" Model Suffix                            | Negative Logic "N" Model Suffix                               |      |     |
| UCE-1.5/20-D48                | 48                              | 34   | 32  | 10-30, model dependent               | 0.05 A <sup>2</sup> sec                 | 50-150, model dependent   | 0.97   | 1-10, model dependent   | L-C  | See notes                          | 1.0  | OFF=Ground pin to +1V max.<br>ON=open or +3.5 to +15V max. | OFF=open or +2.5V to +15V max.<br>ON=Ground pin to +0.8V max. |      |     |
| UCE-1.8/30-D48                |                                 |  | 32.5  |                                      |   |                           | 1.72   |   |  |                                    |  |  |   |      |     |
| UCE-2.5/20-D48                |                                 |  | 32  |                                      |   |                           | 1.53   |   |  |                                    |  |  |   |      |     |
| UCE-3.3/15-D48                |                                 |  | 32  |                                      |   |                           | 1.54   |   |  |                                    |  |  |   |      |     |
| UCE-3.3/30-D48                |                                 |  | 32  |                                      |   |                           | 3.06   |   |  |                                    |  |  |   |      |     |
| UCE-5/10-D48                  |                                 |  | 34.5  |                                      |   |                           | 1.53   |   |  |                                    |  |  |   | Pi   |     |
| UCE-12/4.2-D48                |                                 |  | 34  |                                      |   |                           | 32   |   |  |                                    |  |  |   | 1.52 | L-C |
| UCE-12/8.3-D48                |                                 |  |   |                                      |   |                           | 32   |   |  |                                    |  |  |   | 3.07 |     |
| OUTPUT CHARACTERISTICS        |                                 |  |   |                                      |   |                           |  |   |  |                                    |  |  |   |      |     |
| Model Family                  | V <sub>OUT</sub> V              | V <sub>OUT</sub> Accuracy 50% Load % of V <sub>NOM</sub> | Capacitive Loading Max. Low ESR <0.02Ω Max. resistive load μF | Adjustment Range                     | Temperature Coefficient                 | Minimum Loading           | Remote Sense Compensation  | Ripple/ Noise (20 MHz bandwidth)                                    | Line/Load Regulation                             | Efficiency                         | Current Limit Inception 98% of V <sub>out</sub> , after warmup A |  |   |      |     |
| UCE-1.5/20-D48                | 1.5                             | ±1%  | 10,000  | -10 to +10% of V <sub>nom</sub> .    | ±0.02% of V <sub>out</sub> range per °C | No minimum load           | +10%   | See ordering guide  |  |                                    | 24.5   |  |   |      |     |
| UCE-1.8/30-D48                | 1.8                             |  | 10,000  |                                      |   |                           |  |   |  |                                    | 36   |  |   |      |     |
| UCE-2.5/20-D48                | 2.5                             |  | 10,000  |                                      |   |                           |  |   |  |                                    | 32   |  |   |      |     |
| UCE-3.3/15-D48                | 3.3                             |  | 10,000  |                                      |   |                           |  |   |  |                                    | 24   |  |   |      |     |
| UCE-3.3/30-D48                | 3.3                             |  | 10,000  |                                      |   |                           |  |   |  |                                    | 35   |  |   |      |     |
| UCE-5/10-D48                  | 5                               |  | 1000  |                                      |   |                           |  |   |  |                                    | 15.  |  |   |      |     |
| UCE-12/4.2-D48                | 12                              |  | 1000  |                                      |   |                           |  |   |  |                                    | 5.5  |  |   |      |     |
| UCE-12/8.3-D48                | 12                              |  | 1000  |                                      |   |                           |  |   |  |                                    | 12   |  |   |      |     |
| ISOLATION CHARACTERISTICS     |                                 |  |   |                                      |   |                           |  |   |  |                                    |  |  |   |      |     |
| Model Family                  | Input to Output Min. V          | Input to baseplate Min. V                                | Baseplate to output Min. V                                    | Isolation Resistance MΩ              | Isolation Capacitance pF                | Isolation Safety Rating   |  |   |  |                                    |  |  |   |      |     |
| UCE-1.5/20-D48                | 2250                            | 1500   | 1500  | 100                                  | 1000                                    | Basic Insulation          |  |   |  |                                    |  |  |   |      |     |
| UCE-1.8/30-D48                |                                 |  |   | 10                                   |   |                           |  |   |  |                                    |  |  |   |      |     |
| UCE-2.5/20-D48                |                                 |  |   | 100                                  |   |                           |  |   |  |                                    |  |  |   |      |     |
| UCE-3.3/15-D48                |                                 |  |   |                                      |   |                           |  |   |  |                                    |  |  |   |      |     |
| UCE-3.3/30-D48                |                                 |  |   |                                      |   |                           |  |   |  |                                    |  |  |   |      |     |
| UCE-5/10-D48                  |                                 |  |   |                                      |   |                           |  |   |  |                                    |  |  |   |      |     |
| UCE-12/4.2-D48                |                                 |  |   | 100                                  |   |                           |  |   |  |                                    |  |  |   |      |     |
| UCE-12/8.3-D48                |                                 |  |   |                                      |   |                           |  |   |  |                                    |  |  |   |      |     |
| MISCELLANEOUS CHARACTERISTICS |                                 |  |   |                                      |   |                           |  |   |  |                                    |  |  |   |      |     |
| Model Family                  | Calculated MTBF <sup>4</sup>    | Operating Temperature Range with derating (°C)           | Operating PCB Temperature (no derating)                       | Storage Temperature Range (°C)       | Thermal Protection/Shutdown (°C)        | Short Circuit Current (A) | Overvoltage Protection <sup>12</sup> (V) Via magnetic feedback (V) | Short Circuit Protection Method                                     | Short Circuit Duration <sup>16</sup>             | Relative Humidity (non-condensing) |  |  |   |      |     |
| UCE-1.5/20-D48                | TBC                             | -40 to +85   | -40 to +120   | -55 to +125                          | 120                                     | 5                         | 1.95   | Current limiting, hiccup autorestart. Remove overload for recovery. | Continuous, output shorted to ground. No damage. | to +85°C/85%                       |  |  |   |      |     |
| UCE-1.8/30-D48                |                                 |  |   |                                      |   |                           | 2.8 V. max   |   |  |                                    |  |  |   |      |     |
| UCE-2.5/20-D48                | 1.8 M HRS                       |  |   |                                      |   |                           | TBC  |   |  |                                    | 3  |  |   |      |     |
| UCE-3.3/15-D48                |                                 |  |   |                                      |   |                           |  |   |  |                                    |  |  |   |      |     |
| UCE-3.3/30-D48                |                                 |  |   |                                      |   |                           | 4.25   |   |  |                                    |  |  |   |      |     |
| UCE-5/10-D48                  | 2.6 M HRS                       |  |   |                                      |   |                           | 110  |   |  |                                    | 7 max.   |  |   |      |     |
| UCE-12/4.2-D48                | TBC                             |  |   |                                      |   |                           | 125  |   |  |                                    | 5  | 14.5   |   |      |     |
| UCE-12/8.3-D48                | 2.4 M HRS                       |  |   |                                      |   |                           |  |   |  |                                    |  |  |   |      |     |

### SPECIFICATIONS, CONTINUED

| DYNAMIC CHARACTERISTICS |   |                                    |  |                               |
|-------------------------|---|------------------------------------|--|-------------------------------|
| Model Family            | Dynamic Load Response<br>(50-75-50%<br>load step) to 1%<br>of final value | Start-up Time                      |  | Switching<br>Frequency<br>KHz |
|                         |   | VIN to VOUT<br>regulated<br>(Max.) | Remote On/<br>Off to VOUT<br>regulated<br>(Max.) |                               |
|                         |   |                                    |  |                               |
| UCE-1.5/20-D48          | 100   | 50                                 | 50   | 480                           |
| UCE-1.8/30-D48          | 150   | 10                                 | 10   | 400 ±40                       |
| UCE-2.5/20-D48          | 100   | 50                                 | 50   | 350 ±20                       |
| UCE-3.3/15-D48          | 200   | 50                                 | 50   | 480 ±50                       |
| UCE-3.3/30-D48          | 50  | 15                                 | 10   | 380 ±40                       |
| UCE-5/10-D48            | 100   | 50                                 | 50   | 400 ±20                       |
| UCE-12/4.2-D48          | 30  | 60                                 | 60   | 200 ±10                       |
| UCE-12/8.3-D48          | 30  | 50                                 | 50   |                               |

| ABSOLUTE MAXIMUM RATINGS  |  |
|---|--|
| <b>Input Voltage:</b>   |  |
| Continuous:   | 75 Volts   |
| 48 Volt input models  |  |
| Transient (100 mSec. Max.)  |  |
| 48 Volt input models  | 100 Volts  |
| <b>On/Off Control</b>   | +15 Volts  |
| <b>Input Reverse Polarity Protection</b>  | 5 Amps, 10 sec. max.   |
| <b>Output Overvoltage Protection</b>  | Magnetic feedback.<br>See specifications.  |
| <b>Output Current *</b>   | Current-limited. Devices can<br>withstand sustained short circuit<br>without damage. |
| <b>Storage Temperature</b>  | -40 to +125°C.   |
| <b>Lead Temperature</b>   | +280°C, 10 seconds max.  |
| <p>Absolute maximums are stress ratings. Exposure of devices to any of these conditions may adversely affect long-term reliability. Proper operation under conditions other than those listed in the Performance/Functional Specifications Table is not implied nor recommended.</p> <p>Note: Not all model combinations are available.</p> |  |

### PERFORMANCE SPECIFICATION NOTES

(1) All models are tested and specified with external 11110 µF ceramic/tantalum output capacitors and no external input capacitor. All capacitors are low ESR types. These capacitors are necessary to accommodate our test equipment and may not be required to achieve specified performance in your applications. All models are stable and regulate within spec under no-load conditions.

General conditions for Specifications are +25 deg.C, VIN = nominal, VOUT = nominal, full load. Adequate airflow must be supplied for extended testing under power.

(2) Input Ripple Current is tested and specified over a 5 Hz to 20 MHz bandwidth. Input filtering is CIN = 33 µF, 100V tantalum, CBUS = 220 µF, 100V electrolytic, LBUS = 12 µH.

(3) Note that Maximum Power Derating curves indicate an average current at nominal input voltage. At higher temperatures and/or lower airflow, the DC/DC converter will tolerate brief full current outputs if the total RMS current over time does not exceed the Derating curve. All Derating curves are presented at sea level altitude. Be aware of reduced power dissipation with increasing density altitude.

(4) Mean Time Before Failure is calculated using the Telcordia (Belcore) SR-332 Method 1, Case 3, ground fixed conditions, Tpcboard=+25 deg.C, full output load, natural air convection.

(5) The On/Off Control is normally controlled by a switch. But it may also be driven with external logic or by applying appropriate external voltages which are referenced to Input Common. The On/Off Control Input should use either an open collector or open drain transistor.

(6) Short circuit shutdown begins when the output voltage degrades approximately 2% from the selected setting.

(7) The outputs are not intended to sink appreciable reverse current. This may damage the outputs.

(8) Output noise may be further reduced by adding an external filter. See I/O Filtering and Noise Reduction.

(9) All models are fully operational and meet published specifications, including "cold start" at -40°C.

(10) Regulation specifications describe the deviation as the line input voltage or output load current is varied from a nominal midpoint value to either extreme.

(11) Alternate pin length and/or other output voltages are available under special quantity order.

(12) Output current limit is non-latching. When the overcurrent fault is removed, the converter will immediately recover.

(13) Do not exceed maximum power specifications when adjusting the output trim.

(14) At zero output current, the output may contain low frequency components which exceed the ripple specification. The output may be operated indefinitely with no load.

(15) If reverse polarity is accidentally applied to the input, a body diode will become forward biased and will conduct considerable current. To ensure reverse input protection with full output load, always connect an external input fuse in series with the +VIN input. Use approximately twice the full input current rating with nominal input voltage.

## SPECIFICATIONS, CONTINUED

| PHYSICAL CHARACTERISTICS  |  |                        |
|---|--|------------------------|
| Outline dimensions  | See mechanical specs (below)   |                        |
| Pin material  | Copper alloy   |                        |
| Pin diameter  | 0.04/0.062" (1.016/1.524mm)  |                        |
| Pin finish  | Nickel underplate with gold overplate                                  |                        |
| Weight  | UCE-1.5/20-D48   | 0.67 ounces (19 grams) |
|   | UCE-1.8/30-D48,<br>UCE-2.5/20-D48                                      | 0.71 ounces (20 grams) |
|   | UCE-5/10-D48   |                        |
|   | UCE-12/4.2-D48   |                        |
|   | UCE-3.3/15-D48   | 1 ounce (28 grams)     |
|   | UCE-3.3/30-D48, UCE-12/8.3-D48   | 0.81 ounces (23 grams) |
| Electromagnetic interference (conducted and radiated)<br>(external filter required) | FCC part 15, class B, EN55022  |                        |
| Safety  | Designed to meet UL/cUL 60950-1, CSA-C22.2 No. 60950-1, IEC/EN 60950-1 |                        |

**MECHANICAL SPECIFICATIONS**

**Without Baseplate**

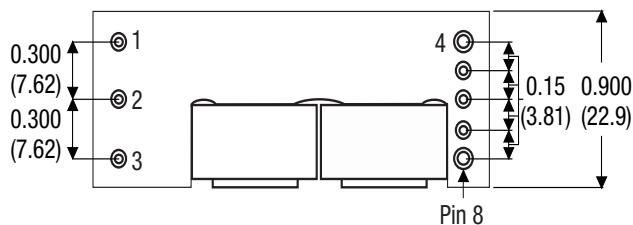
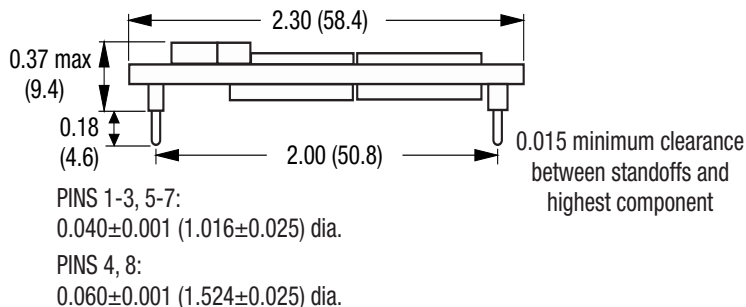

Dimensions are in inches (mm shown for ref. only).

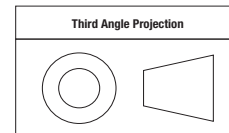

Tolerances (unless otherwise specified):  
.XX ± 0.02 (0.5)  
.XXX ± 0.010 (0.25)  
Angles ± 2°

Components are shown for reference only.

**With Baseplate**

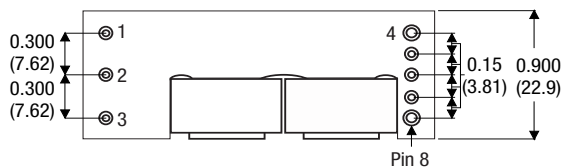
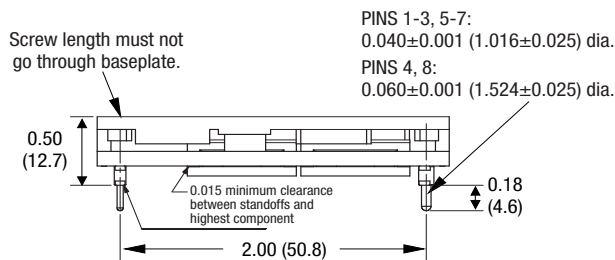

Dimensions are in inches (mm).  
Typical component locations are shown. Actual units may vary.

**INPUT/OUTPUT CONNECTIONS**

| Pin | Function P32   |
|-----|----------------|
| 1   | -Input         |
| 2   | On/Off Control |
| 3   | +Input         |
| 4   | -Output        |
| 5   | -Sense         |
| 6   | Output Trim    |
| 7   | +Sense         |
| 8   | +Output        |

**Trim Equations**

**Trim Down**

Connect trim resistor between trim pin and -Sense

$$R_{TrimDn} (k \Omega) = \frac{5.11}{\Delta} - 10.22$$

**Trim Up**

Connect trim resistor between trim pin and +Sense

$$R_{TrimUp} (k \Omega) = \frac{5.11 \times V_{NOM} \times (1 + \Delta)}{1.225 \times \Delta} - \frac{5.11}{\Delta} - 10.22$$

**Where,**

$$\Delta = | (V_{NOM} - V_{OUT}) / V_{NOM} |$$

$V_{NOM}$  is the nominal, untrimmed output voltage.

$V_{OUT}$  is the desired new output voltage.

Do not exceed the specified trim range or maximum power ratings when adjusting trim.

Use 1% precision resistors mounted close to the converter on short leads.

**Trim Circuits**

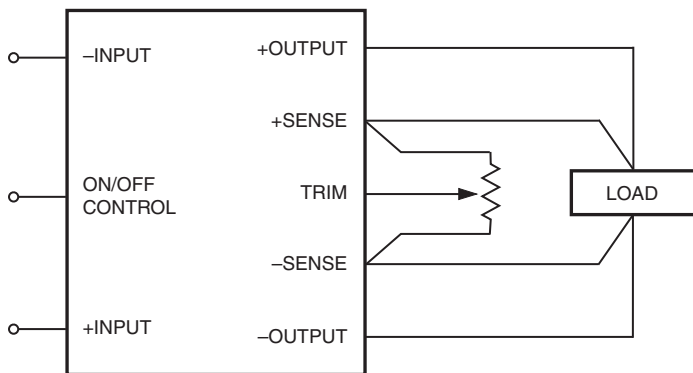

Figure A. Trim Connections Using A Trimpot

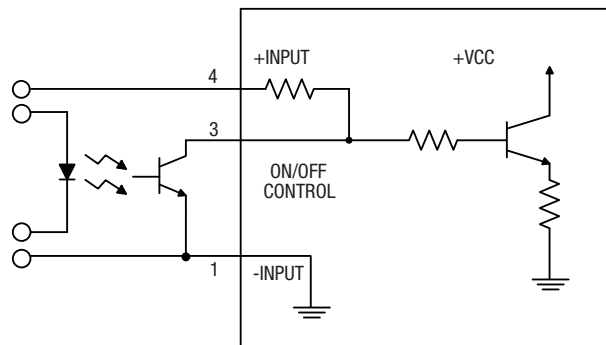

Figure C. Driving the On/Off Control Pin (suggested circuit)

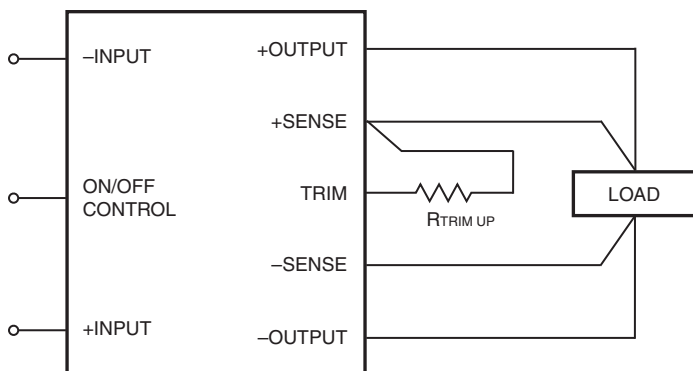

Figure B. Trim Connections To Increase Output Voltages

Connect sense to its respective  $V_{out}$  pin if sense is not used with a remote load.

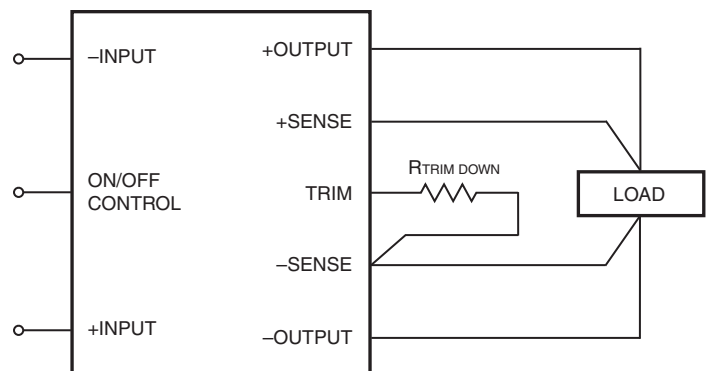
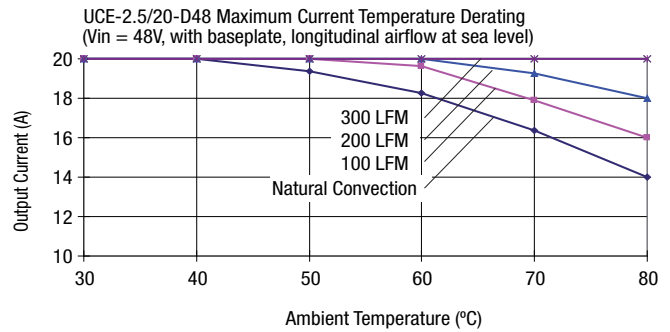
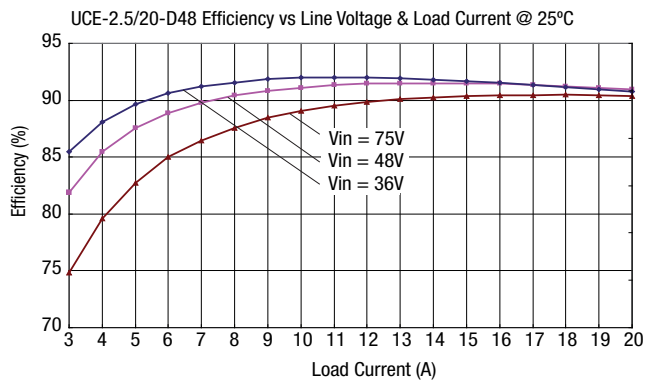
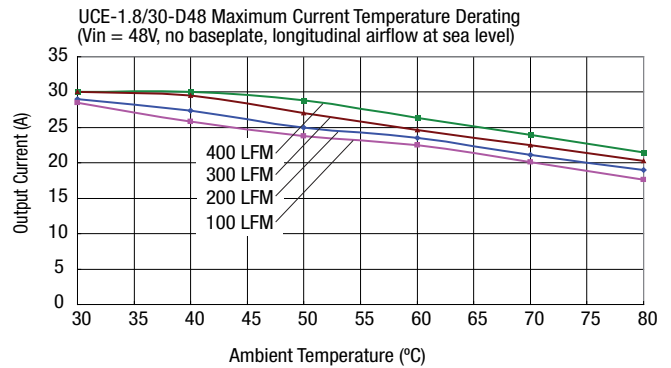
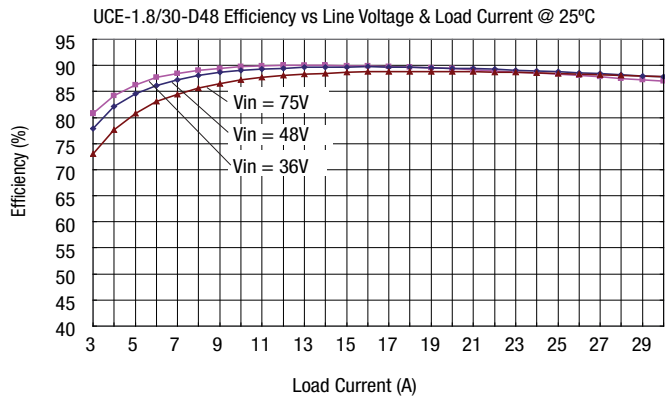
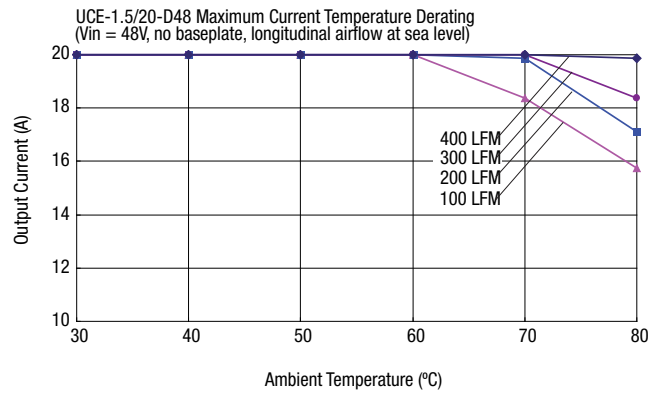
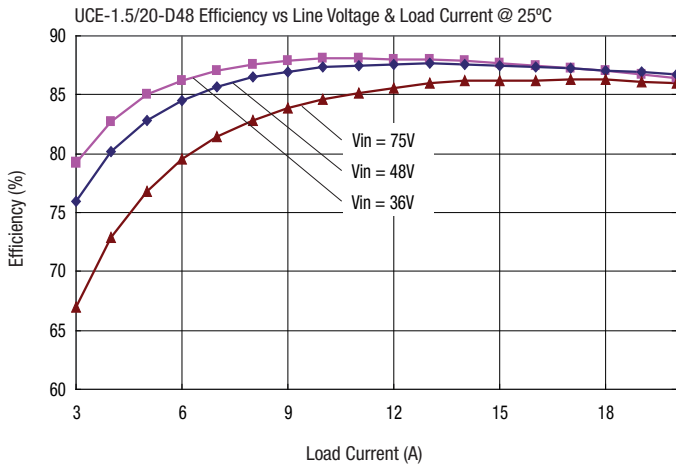

Figure D. Trim Connections To Decrease Output Voltages

**Typical Performance Curves**





**Typical Performance Curves**

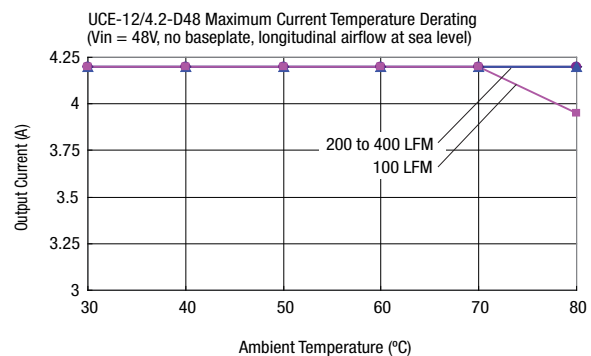
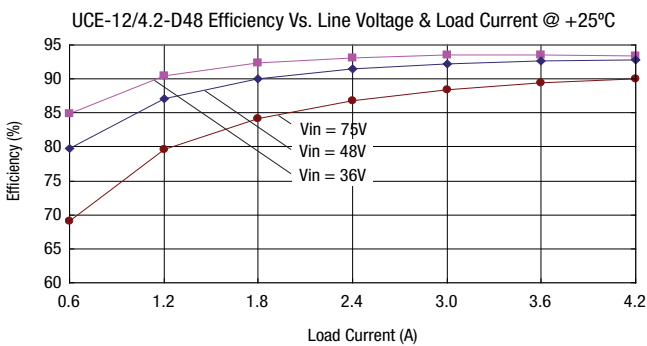
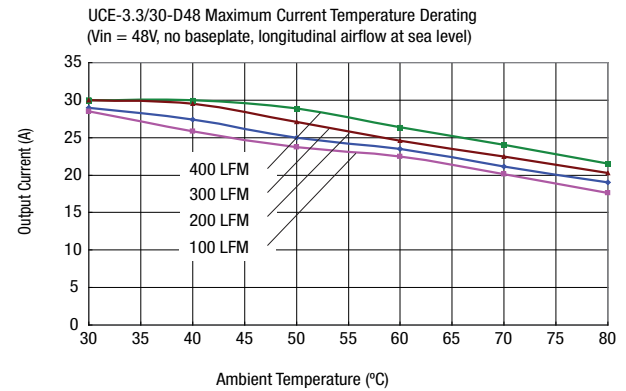
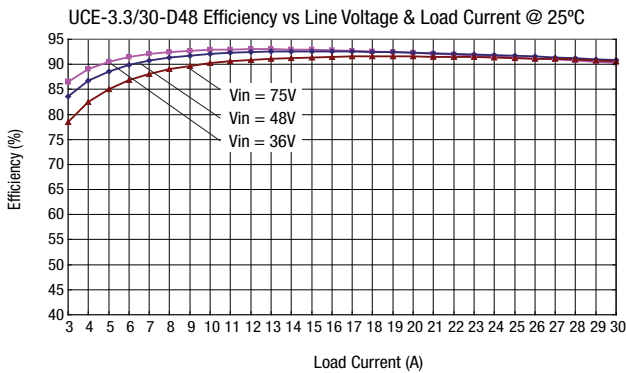
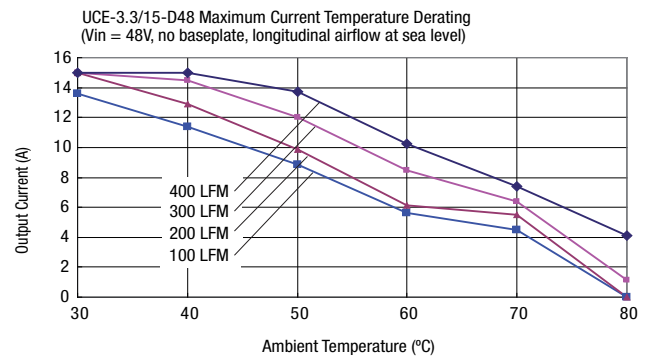
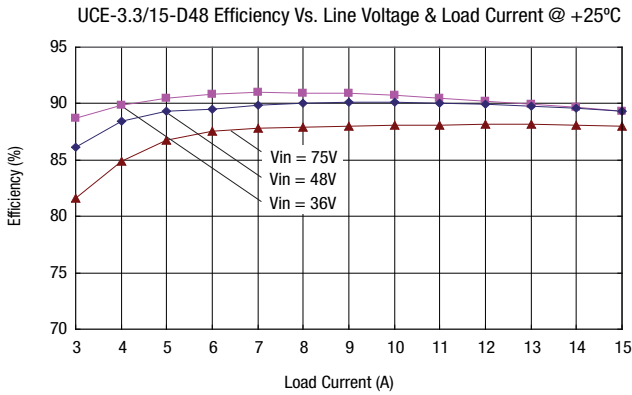

**Typical Performance Curves**

