

AV60A Dual Output Half-brick

Technical Reference Notes

48V Input, 5V/3.3V and 3.3V/2.5V Dual Output

75W DC-DC Converter

(REV 01)



Introduction

AV60A dual output series provides two independent and fully regulated positive outputs, the outputs are also separately trimmable. A remote on/off feature is included as standard. AV60A dual output isolated DC/DC converters is built using the industry standard half-brick pin-out and package 61.0mm x 57.9mm x 12.7mm (2.4" x 2.28" x 0.5"). Typical efficiencies are 82% for the 5V/3.3V outputs, and 80% for the 3.3V/2.5V outputs. The AV60A dual output series is available with 2:1 input range of 36V-75V, and with output combination of 5V/3.3V and 3.3V/2.5V at maximum current of 15 Amps. The maximum current can be drawn from either output, or in any combination, as long as the total output current does not exceed 15 Amps. The output power is 75W. The input-output isolation is 1500Vdc.

AV60A dual output series is designed to meet CISPR22, FCC Class A, UL, TUV, and CSA certifications.

Features

1. Two independent positive outputs
2. Each output is separately trimmable
3. CNT function
4. High efficiency
5. High power density
6. Low output noise
7. Metal baseplate
8. Input undervoltage protection
9. Short circuit protection
10. Over current protection
11. Output overvoltage protection
12. Wide operating case temperature:
-40°C ~ 100°C

**AV60A DUAL OUTPUT HALF-BRICK POWER CONVERTERS
36VDC TO 75VDC INPUT, 75 WATT OUTPUT**

Typical Application

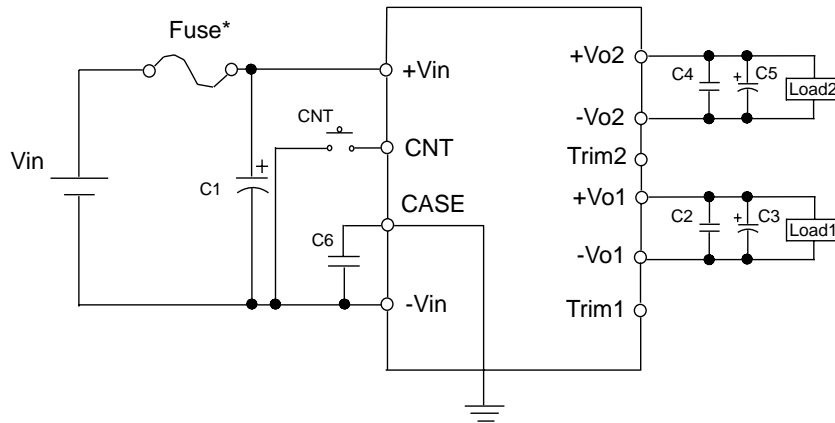

NOTE: The figure is Positive Logic Control, if the CNT pin is left open, the converter will default to “control on” operation. **Negative Logic Control is also available.**

Positive Logic Control: Low=Off, High=On. Negative Logic Control: Low=On, High=Off.

Recommended External components:

- Fuse* : Recommended: 3~4A.
- C1 : Recommended 470 μ F/100V.
- C3=C5 : Recommended electrolytic capacitor of 470 μ F/16V.
- C2=C4 : Recommended metallitic film capacitor of 0.47 μ F/16V.
- C6 : Recommended 0.01 μ F/1500V.

Block Diagram

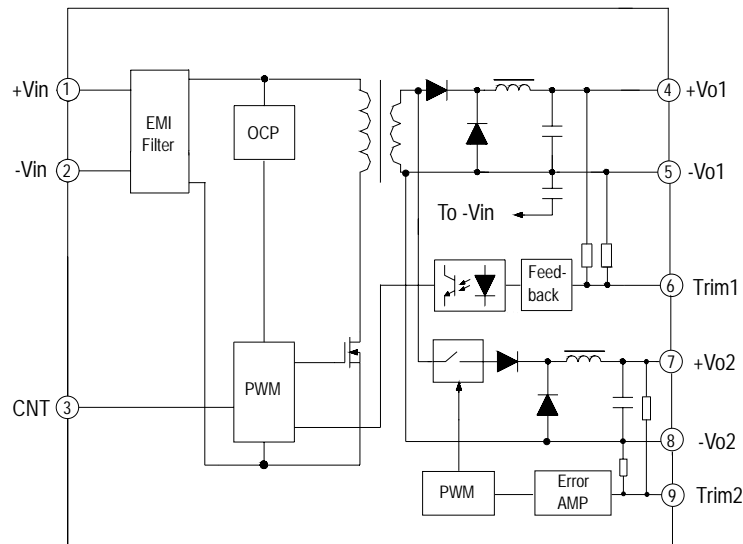

**AV60A DUAL OUTPUT HALF-BRICK POWER CONVERTERS
36VDC TO 75VDC INPUT, 75 WATT OUTPUT**

Ordering Information

Model Number	Input Voltage (V)	Output Voltage (V)	Output Current (A)	Ripple (mV rms) max	Noise (mV pp) max	Efficiency (%)		notes and conditions
						min	typ	
AV60A-048L-050D033	48	5, 3.3	15, 15*	30	150	80	82	Io1=15A, Io2=0A
							82	Io1=7.5A, Io2=7.5A
							79	Io1=1.5A, Io2=15A
AV60A-048L-033D025	48	3.3, 2.5	15, 15*	25	150	78	80	Io1=15A, Io2=0A
							80	Io1=7.5A, Io2=7.5A
							76	Io1=1.5A, Io2=15A
AV60A-048L-050D033N*	48	5, 3.3	15, 15*	30	150	80	82	Io1=15A, Io2=0A
							82	Io1=7.5A, Io2=7.5A
							79	Io1=1.5A, Io2=15A
AV60A-048L-033D025N*	48	3.3, 2.5	15, 15*	25	150	78	80	Io1=15A, Io2=0A
							80	Io1=7.5A, Io2=7.5A
							76	Io1=1.5A, Io2=15A

Note: The maximum output current of auxiliary output Vo2 is 12A when the case temperature is between 80~100°C.

The products with suffix 'N' refer to the negative logic control products, default is positive logic control.

The products with suffix '-7' refer to products with pin length of 5.8mm.

The products with suffix '-6' refer to products with pin length of 3.8mm.

The products with suffix '-8' refer to products with pin length of 2.8mm.

Default pin length is 4.8mm.

**AV60A DUAL OUTPUT HALF-BRICK POWER CONVERTERS
36VDC TO 75VDC INPUT, 75 WATT OUTPUT**

Absolute Maximum Rating

Characteristic	Min	Typ	Max	Units	Notes
Input Voltage(continuous)	-0.3		80	Vdc	100ms non-repetitive
Input Voltage(peak/surge)	-0.3		100	Vdc	
Case temperature	-40		100	°C	
storage temperature	-55		125	°C	

Input Characteristics

Characteristic	Min	Typ	Max	Units	Notes
Input Voltage Range	36	48	75	Vdc	Vin=48V, Io1=7.5A, Io2=7.5A
Input Reflected Current			200	mAp-p	
Turn-off Input Voltage	30	33	35	V	
Turn-on Input Voltage	31	34	36	V	
Turn On Time		5		ms	
Turn On Delay		10		ms	

CNT Function

Characteristic	Min	Typ	Max	Units	Notes
Logic High	5		15	Vdc	Reverse logic option available.
Logic Low	0		1.2	Vdc	
Control Current			2	mA	

General Specifications

Characteristic	Min	Typ	Max	Units	Notes
MTBF		2300		k Hrs	Bellcore TR332, 25°C
Isolation			1500	Vdc	
Pin solder temperature			260	°C	wave solder < 15 s
Hand Soldering Time			5	s	iron temperature 425°C
Weight			65	grams	

**AV60A DUAL OUTPUT HALF-BRICK POWER CONVERTERS
36VDC TO 75VDC INPUT, 75 WATT OUTPUT**

AV60A-048L-033D025(N) Output Characteristics

Characteristic	Min	Typ	Max	Units	Notes
Power		75		W	
Output Current		15/15		A	
Output Setpoint Voltage	3.25	3.3	3.35	Vdc	Vin=48V, Io1=7.5A, Io2=7.5A
	2.45	2.5	2.55	Vdc	Vin=48V, Io1=7.5A, Io2=7.5A
Line Regulation					
Vo1		±0.2		%Vo	Vin=36~75V, Io1=7.5A, Io2=7.5A
Vo2		±0.2		%Vo	Vin=36~75V, Io1=7.5A, Io2=7.5A
Load Regulation					
Vo1		±0.5		%Vo	Io1=0~15A, Io2=0A, Vin=48V
Vo2		±0.5		%Vo	Io1=1.5A, Io2=0~15A, Vin=48V
Dynamic Response					
50-75% load		5		%Vo	Ta=25°C, DI/Dt=1A/10µs
		200		µs	Ta=25°C, DI/Dt=1A/10µs
50-25% load		5		%Vo	Ta=25°C, DI/Dt=1A/10µs
		200		µs	Ta=25°C, DI/Dt=1A/10µs
Current Limit Threshold	16.5		25	A	Vin=48V, Io1+Io2
Short Circuit Current		170		Iomax%	Vin=48V, Io1=Io2=7.5A
Efficiency	78	80		%	Vin=48V, Io1=Io2=7.5A
Trim Range	90		110	%Vo	
Over Voltage Protection Setpoint	4.0		5	V	Vo=3.3V
	3.0		3.9	V	Vo=2.5V
Temperature Regulation			0.03	%Vo/°C	
Ripple (rms)			25	mV	(0-20MHz BW)
Noise (p-p)			150	mV	(0-20MHz BW)
Over Temperature Protection		105		°C	Vin=48V, Io1=7.5A, Io2=7.5A
Switching Frequency		300		kHz	

**AV60A DUAL OUTPUT HALF-BRICK POWER CONVERTERS
36VDC TO 75VDC INPUT, 75 WATT OUTPUT**

AV60A-048L-050D033(N) Output Characteristics

Characteristic	Min	Typ	Max	Units	Notes
Power		75		W	
Output Current		15/15		A	
Output Setpoint Voltage	4.95	5	5.05	Vdc	Vin=48V, Io1=7.5A, Io2=7.5A
	3.25	3.3	3.35	Vdc	Vin=48V, Io1=7.5A, Io2=7.5A
Line Regulation					
Vo1		±0.2		%Vo	Vin=36~75V, Io1=7.5A, Io2=7.5A
Vo2		±0.2		%Vo	Vin=36~75V, Io1=7.5A, Io2=7.5A
Load Regulation					
Vo1		±0.5		%Vo	Io1=0~15A, Io2=0A, Vin=48V
Vo2		±0.5		%Vo	Io1=0.5A, Io2=0~15A, Vin=48V
Dynamic Response					
50-75% load		5		%Vo	T=25°C, DI/Dt=1A/10µs
		200		µs	T=25°C, DI/Dt=1A/10µs
50-25% load		5		%Vo	T=25°C, DI/Dt=1A/10µs
		200		µs	T=25°C, DI/Dt=1A/10µs
Current Limit Threshold	16.5		25	A	Vin=48V, Io1+Io2
Short Circuit Current		170		Iomax%	Vin=48V, Io1=Io2=7.5A
Efficiency	80	82		%	Vin=48V, Io1=Io2=7.5A
Trim Range	90		110	%Vo	
Over Voltage Protection	5.75		7	V	Vo=5V
	4.0		5	V	Vo=3.3V
Temperature Regulation			0.03	%Vo/°C	
Ripple (rms)			30	mV	(0-20MHz BW)
Noise (p-p)			150	mV	(0-20MHz BW)
Over Temperature Protection		105		°C	Vin=48V, Io1=7.5A, Io2=7.5A
Switching Frequency		300		kHz	

**AV60A DUAL OUTPUT HALF-BRICK POWER CONVERTERS
36VDC TO 75VDC INPUT, 75 WATT OUTPUT**

Characteristic Curves

**AV60A-048L-050D033(N) Typical Efficiency vs Vin
5V:load variable; 3.3V:no load**

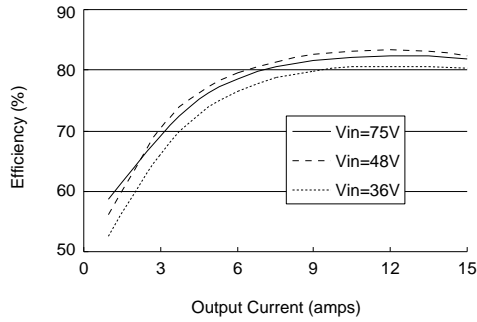

**AV60A-048L-050D033(N) Typical Efficiency vs Vin
5V@0.5A; 3.3V:load variable**

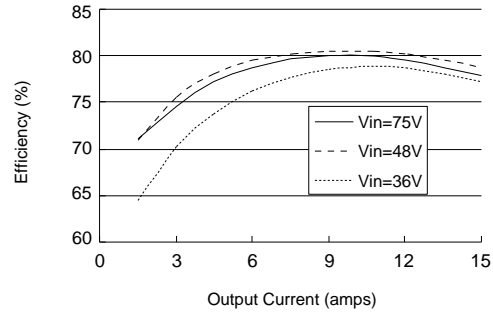

**AV60A-048L-033D025(N) Typical Efficiency vs Vin
3.3V:load variable; 2.5V:no load**

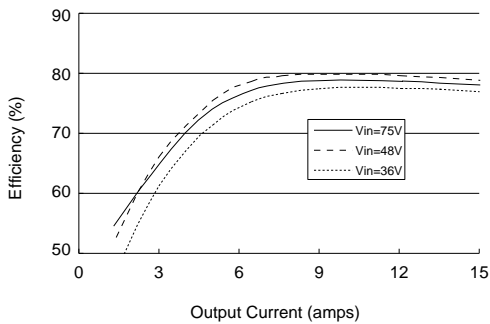

**AV60A-048L-033D025(N) Typical Efficiency vs Vin
3.3V@1.5A; 2.5V:load variable**

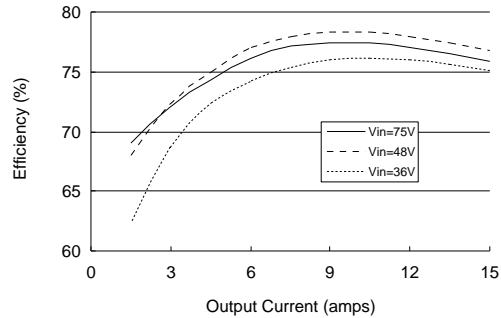

**AV60A DUAL OUTPUT HALF-BRICK POWER CONVERTERS
36VDC TO 75VDC INPUT, 75 WATT OUTPUT**

Characteristic Curves (continued)

**AV60A-048L-050D033(N)
Typical Cross Regulation**

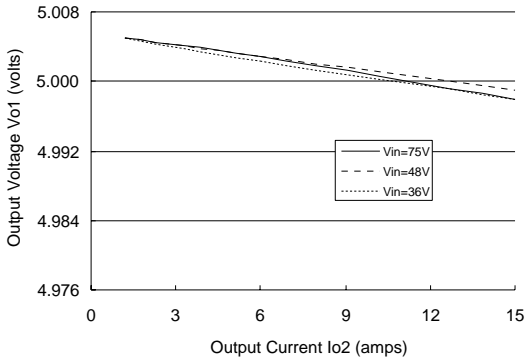

**AV60A-048L-033D025(N)
Typical Cross Regulation**

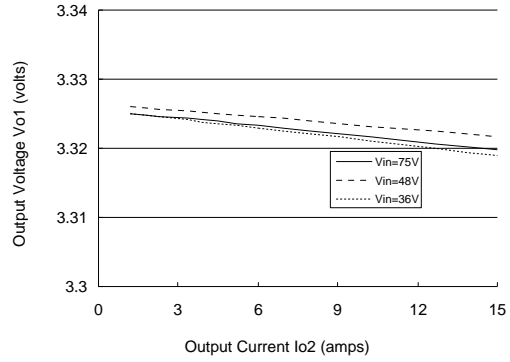

**AV60A-048L-050D033(N)
Typical Overcurrent Performance**

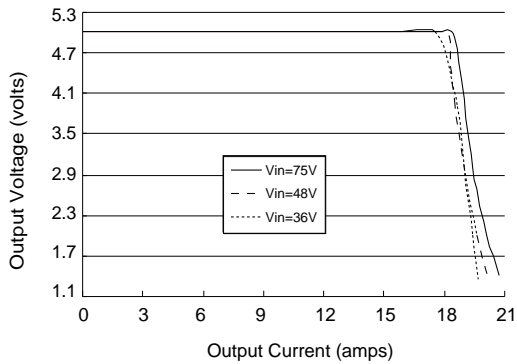

**AV60A-048L-033D025(N)
Typical Overcurrent Performance**

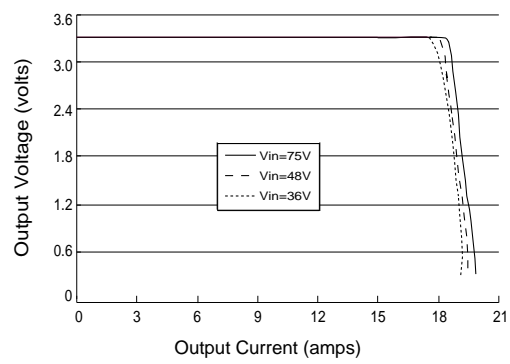

**AV60A DUAL OUTPUT HALF-BRICK POWER CONVERTERS
36VDC TO 75VDC INPUT, 75 WATT OUTPUT**

Characteristic Curves (continued)

AV60A-048L-050D033(N) Typical Output Voltage Startup From Power On

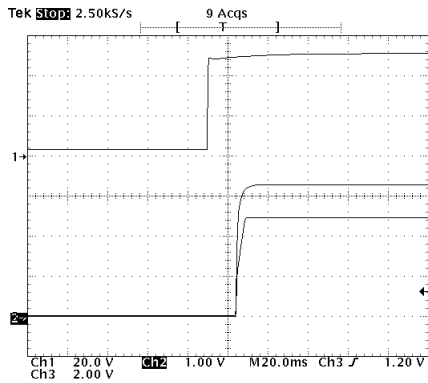

AV60A-048L-033D025(N) Typical Output Voltage Startup From Power On

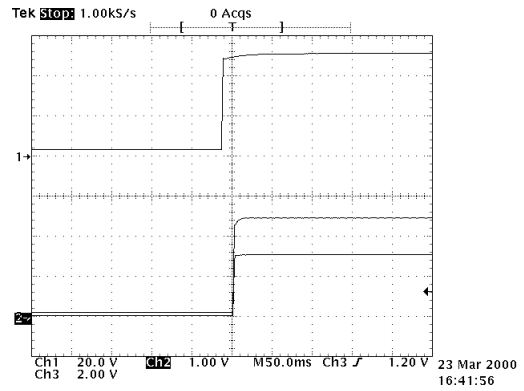

AV60A-048L-033D025(P) Typical Transient Response 25%- 50%- 25%

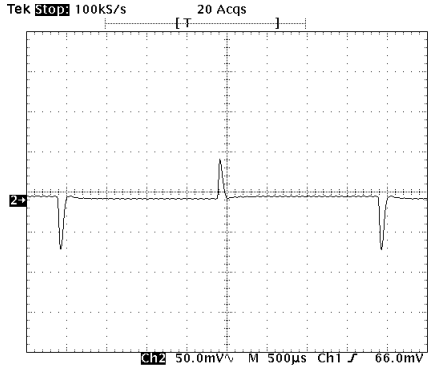

AV60A-048L-050D033(P) Typical Transient Response 25%- 50%- 25%

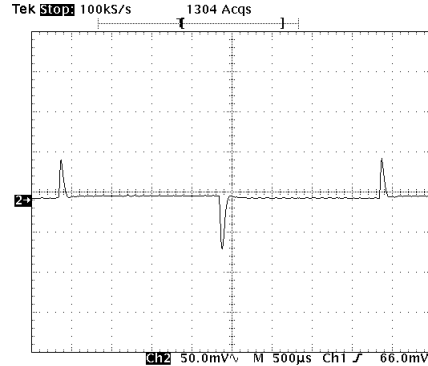

Typical Output Current Safe Operating Area vs Case Temperature (Natural Convection)

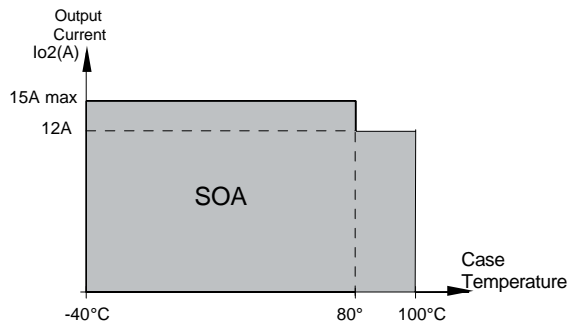

Pin Location

The +Vin and -Vin input connection pins are located as shown in Figure 1. AV60A dual output converters have a 2:1 input voltage range and 48 Vin converters can accept 36-75 Vdc. Care should be taken to avoid applying reverse polarity to the input which can damage the converter.

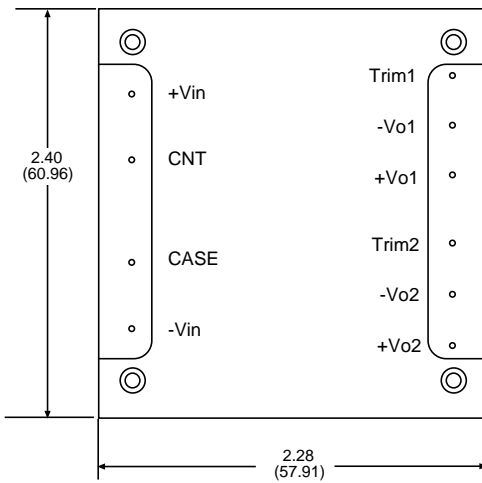

Fig.1 Pins Location
(baseplate-side footprint)

Input Characteristic

Fusing

The AV60A dual output power module has no internal fuse. An external fuse must always be employed! To meet international safety requirements, a 250 Volt rated fuse should be used. If one of the input lines is connected to chassis ground, then the fuse must be placed in the other input line.

Standard safety agency regulations require input fusing. Recommended fuse ratings for the AV60A dual output series are 6-8A.

Input Reverse Voltage Protection

Under installation and cabling conditions where reverse polarity across the input may occur, reverse polarity protection is recommended. Protection can easily be provided as shown in Figure 2. In both cases the diode rating is 7.5A/100V. **Placing the diode across the inputs rather than in-line with the input offers an advantage in that the diode only conducts in a reverse polarity condition, which increases circuit efficiency and thermal performance.**

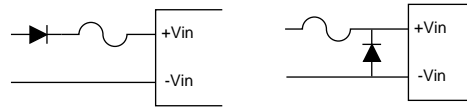

Fig.2. Reverse Polarity Protection Circuits

Input Undervoltage Protection

The AV60A series is protected against undervoltage on the input. If the input voltage drops below the acceptable range, the converter will shut down. It will automatically restart when the undervoltage condition is removed.

Input Filter

Input filters are included in the converters to help achieve standard system emissions certifications. Some users however, may find that additional input filtering is necessary. The AV60A series has an internal switching frequency of 300 kHz, so a high frequency capacitor mounted close to the input terminals produces the best results. To reduce reflected noise, a capacitor can be added across the input as shown in Figure 3, forming a π filter. A 470 μ F/100V electrolytic capacitor is recommended for C1.

For conditions where EMI is a concern, a differ-

**AV60A DUAL OUTPUT HALF-BRICK POWER CONVERTERS
36VDC TO 75VDC INPUT, 75 WATT OUTPUT**

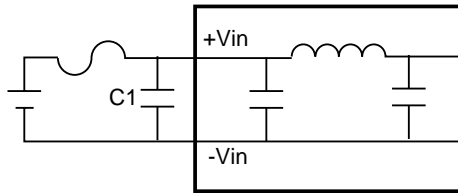

Fig.3 Ripple Rejection Input Filter

ent input filter can be used. Figure 4 shows an input filter designed to reduce EMI effects. C1 is a 470 μ F/100V electrolytic capacitor, and C2 is a 1 μ F/100V metal film or ceramic high frequency capacitor, Cy1 and Cy2 are each 1000pF/1500Vdc high frequency ceramic capacitors, and L1 is a 1mH common mode choke.

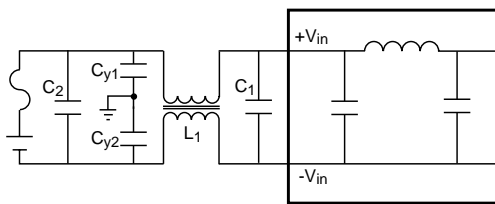

Fig.4 EMI Reduction Input Filter

When a filter inductor is connected in series with the power converter input, an input capacitor C1 should be added. An input capacitor C1 should also be used when the input wiring is long, since the wiring can act as an inductor. Failure to use an input capacitor under these conditions can produce large input voltage spikes and an unstable output.

CNT Function

The AV60A dual output series provides a control function allowing the user to turn the output on and off using an external circuit. Two remote on/off options are available. **Positive logic** applying a voltage less than 1.2V to the CNT pin will disable the output, and applying a volt-

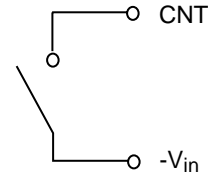

Fig.5 Simple Control

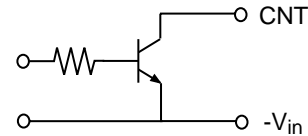

Fig.6 Transistor Control

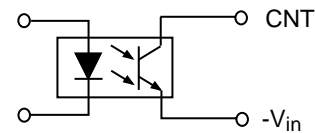

Fig.7 Isolated Control

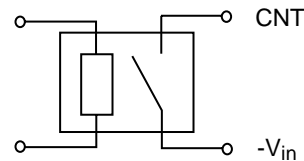

Fig.8 Relay Control

age greater than 5V will enable it. **Negative logic** applying a voltage less than 1.2V to the CNT pin will enable the output, and applying a voltage greater than 5V will disable it. The performance of the converter between these two points will depend on the individual converter and whether the control voltage is increasing or decreasing.

If the CNT pin is left open, the converter will default to “control on” operation for positive logic, but default to “Control off” for negative logic. The maximum voltage that can be applied to the control pin is 15 volts.

If the CNT function is not used:

Negative logic: connect CNT pin to Vi(-).

Positive logic: leave CNT pin open.

Input-Output Characteristic

Safety Consideration

For safety-agency approval of the system in which the power module is used, the power module must be installed in compliance with the spacing and separation requirements of the end-use safety agency standard, i.e., UL1950, CSA C22.2 No. 950-95, and EN60950. The input-to-output 1500VDC isolation is an operational insulation. The DC/DC power module should be installed in end-use equipment, in compliance with the requirements of the ultimate application, and is intended to be supplied by an isolated secondary circuit. When the supply to the DC/DC power module meets all the requirements for SELV(<60Vdc), the output is considered to remain within SELV limits (level 3). If connected to a 60Vdc power system, double or reinforced insulation must be provided in the power supply that isolates the input from any hazardous voltages, including the ac mains. One Vi pin and one Vo pin are to be grounded or both the input and output pins are to be kept floating. Single fault testing in the power supply must be performed in combination with the DC/DC power module to demonstrate that the output meets the requirement for SELV. The input pins of the module are not operator accessible.

Note: Do not ground either of the input pins of the module, without grounding one of the output pins. This may allow a non-SELV voltage to appear between the output pin and ground.

Case Grounding

For proper operation of the module, the case or baseplate of the The AV60A dual output series module does not require a connection to a chassis ground. If the series is not in a metallic enclosure in a system, it may be advisable to directly ground the case to reduce electric field emissions. Leaving the case floating can help to reduce magnetic field radiation from common

mode noise currents. If the case has to be grounded for safety or other reasons, an inductor can be connected to chassis at DC and AC line frequencies, but be left floating at switching frequencies. Under the condition, the safety requirements are met and the emissions are minimized.

Output Characteristics

Minimum Load Requirement

In order to maintain proper operation and specifications, there is a 1.5A minimum load requirement on +Vo1(3.3V output) for AV60A-048L-033D025(N), and 0.5A minimum load requirement on +Vo1(5V output) for AV60A-048L-050D033(N). Contact the factory for details.

Output Over-Voltage Protection

The over-voltage protection has a separate feedback loop which activates when the output voltage is between 120% and 150% of the nominal output voltage. When an over-voltage condition occurs, a "turn off" signal was sent to the input of the module which will shut down the output. The module will restart after power on again.

Output Trimming

Users can increase or decrease the output voltage by adding an external resistor between the TRIM pin and either the Vo (+) or Vo (-) pins. The trim resistor should be positioned close to the module. **If the trim feature is not used, leave the TRIM pin open.**

Trimming up by more than 10% of the nominal output may damage the converter. Trimming down more than 10% can cause the converter to regulate improperly. Trim down and trim up circuits and equations are shown in following Figures.

Note that at elevated output voltages the maximum power rating of the module remains the same, and the output current capability will decrease correspondingly.

AV60A DUAL OUTPUT HALF-BRICK POWER CONVERTERS 36VDC TO 75VDC INPUT, 75 WATT OUTPUT

component-side footprint

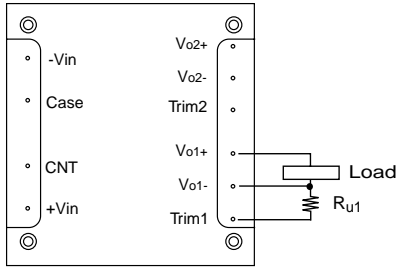

AV60A-048L-050D033(N):
5V Out: $R_{u1} = \frac{(5.76 - V_o') \times 3.3}{V_o' - 5}$

AV60A-048L-033D025(N):
3.3V Out: $R_{u1} = \frac{(3.776 - V_o') \times 5.11}{V_o' - 3.3}$

Where V_o is the output voltage after trim-up.
 R_{u1} is in $k\Omega$.

Fig.9 Output Voltage V_{o1} Trim-up

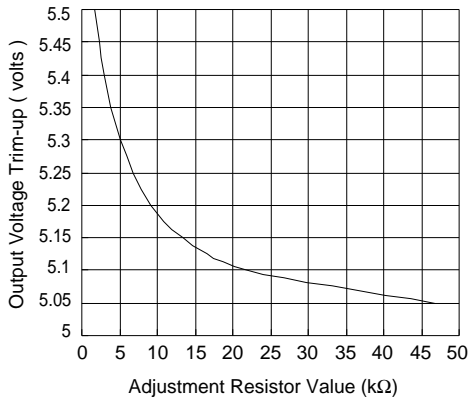

Fig.10 Typical Trim-up Curves for AV60A-048L-050D033(N) 5V Outputs

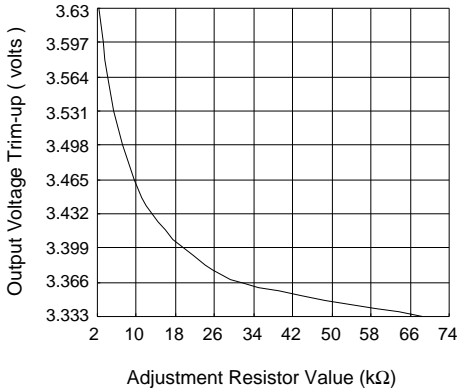
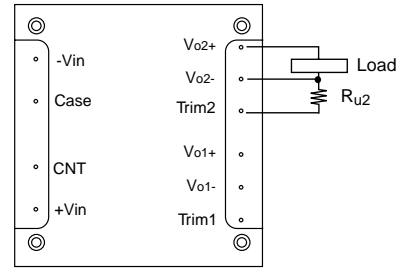

Fig.11 Typical Trim-up Curves for AV60A-048L-033D025(N) 3.3V Outputs



AV60A-048L-050D033(N):
3.3V Out: $R_{u2} = \frac{(5.825 - V_o') \times 0.33}{V_o' - 3.3}$

AV60A-048L-033D025(N):
2.5V Out: $R_{u2} = \frac{(3.1388 - V_o') \times 10}{V_o' - 2.5}$

Where V_o is the output voltage after trim-up.
 R_{u2} is in $k\Omega$.

Fig.12 Output Voltage V_{o2} Trim-up

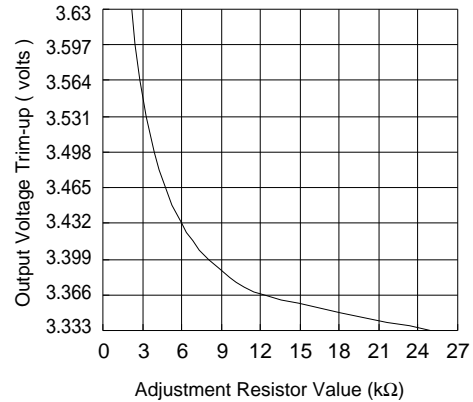

Fig.13 Typical Trim-up Curves for AV60A-048L-050D033(N) 3.3V Outputs

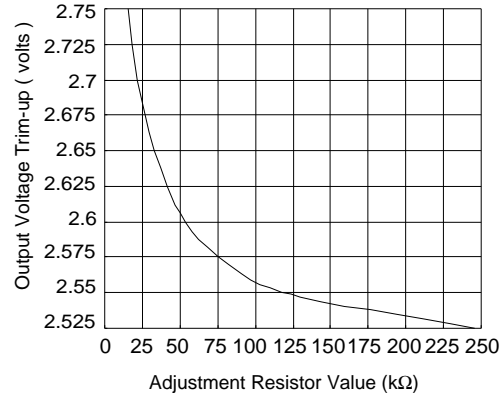
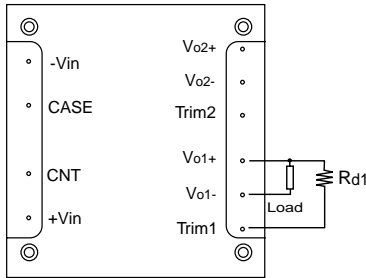

Fig.14 Typical Trim-up Curves for AV60A-048L-033D025(N) 2.5V Outputs

AV60A DUAL OUTPUT HALF-BRICK POWER CONVERTERS 36VDC TO 75VDC INPUT, 75 WATT OUTPUT

component-side footprint



AV60A-048L-050D033(N):
5V Out: $R_{d1} = \frac{(V_o' - 4.42) \times 4.3}{5 - V_o'}$

AV60A-048L-033D025(N):
3.3V Out: $R_{d1} = \frac{(V_o' - 2.785) \times 6.8}{3.3 - V_o'}$

Where V_o' is the output voltage after trim-down.
 R_{d1} is in $k\Omega$.

Fig.15 Output Voltage V_{o1} Trim-down

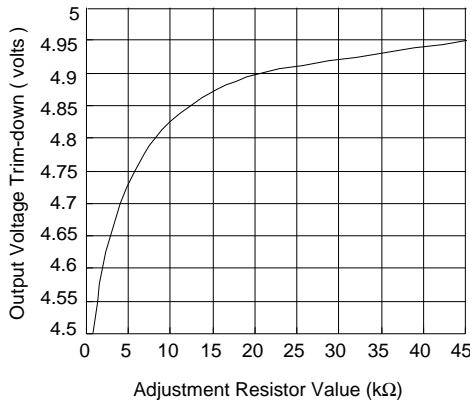

Fig.16 Typical Trim-down Curves for AV60A-048L-050D033(N) 5V Outputs

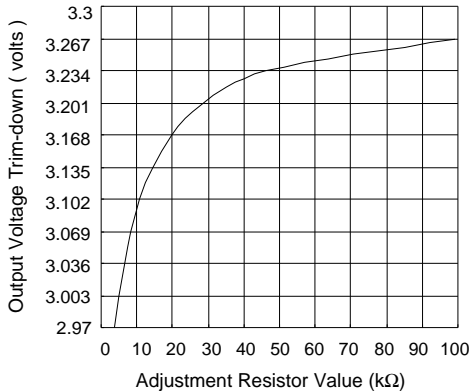
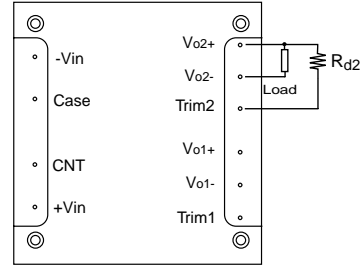

Fig.17 Typical Trim-down Curves for AV60A-048L-033D025(N) 3.3V Outputs



AV60A-048L-050D033(N):
3.3V Out: $R_{d2} = \frac{(V_o' - 2.89) \times 0.66}{3.3 - V_o'}$

AV60A-048L-033D025(N):
2.5V Out: $R_{d2} = \frac{(V_o' - 2.0773) \times 15.11}{2.5 - V_o'}$

Where V_o' is the output voltage after trim-down.
 R_{d2} is in $k\Omega$.

Fig.18 Output Voltage V_{o2} Trim-down

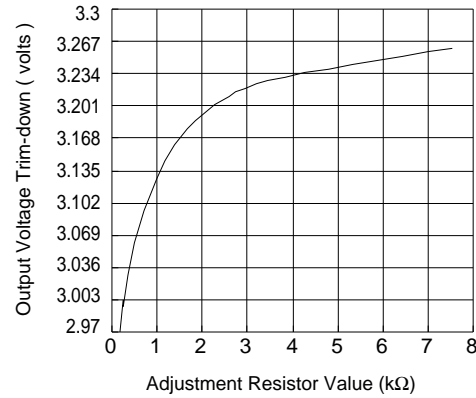

Fig.19 Typical Trim-down Curves for AV60A-048L-050D033(N) 3.3V Outputs

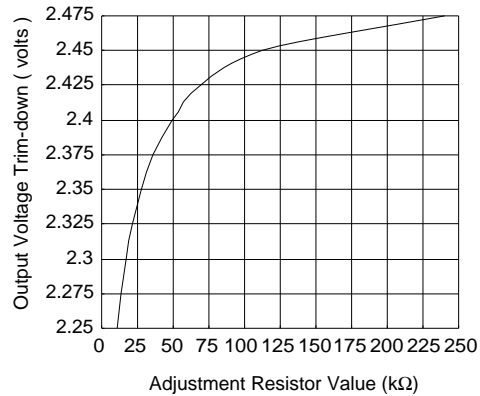

Fig.20 Typical Trim-down Curves for AV60A-048L-033D025(N) 2.5V Outputs

Output Over-Current Protection

AV60A dual output DC/DC converters feature continuously current limiting as part of their Overcurrent Protection (OCP) circuits. When output current exceeds 110 to 140% of rated current, such as during a short circuit condition, the output will shutdown immediately, and can tolerate short circuit conditions indefinitely. When the overcurrent condition is removed, the converter will automatically restart.

Output Filters

When the load is sensitive to ripple and noise, an output filter can be added to minimize the effects. A simple output filter to reduce output ripple and noise can be made by connecting a capacitor across the output as shown in Figure 21. The recommended value for the output capacitor C1 is 470 μ F/16V.

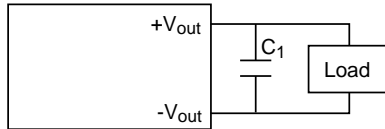

Fig.21. Output Ripple Filter

Extra care should be taken when long leads or traces are used to provide power to the load. Long lead lengths increase the chance for noise to appear on the lines. Under these conditions C2 can be added across the load as shown in Figure 22. The recommended component for C2 is 470 μ F/16V capacitor and connecting a 0.1 μ F ceramic capacitor C1 in parallel generally.

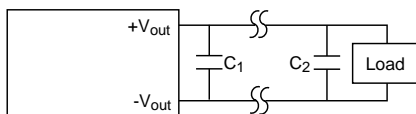

Fig.22 Output Ripple Filter For a Distant Load

Decoupling

Noise on the power distribution system is not always created by the converter. High speed analog or digital loads with dynamic power demands can cause noise to cross the power inductor back onto the input lines. Noise can be reduced by decoupling the load. In most cases, connecting a 10 μ F tantalum capacitor in parallel with a 0.1 μ F ceramic capacitor across the load will decouple it. The capacitors should be connected as close to the load as possible.

Ground Loops

Ground loops occur when different circuits are given multiple paths to common or earth ground, as shown in Figure 23. Multiple ground points can slightly different potential and cause current flow through the circuit from one point to another. This can result in additional noise in all the circuits. To eliminate the problem, circuits should be designed with a single ground connection as shown in Figure 24.

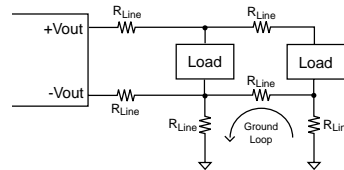

Fig.23 Ground Loops

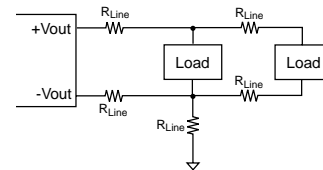

Fig.24 Single Point Ground

Parallel Power Distribution

Figure 25 shows a typical parallel power distribution design. Such designs, sometimes called daisy chains, can be used for very low output currents, but are not normally recommended. The voltage across loads far from the source

can vary greatly depending on the IR drops along the leads and changes in the loads closer to the source. Dynamic load conditions increase the potential problems.

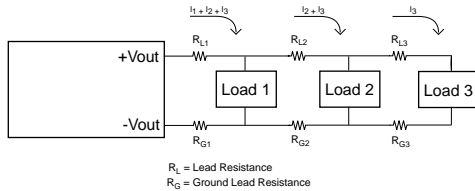

Fig.25 Parallel Power Distribution

Radial Power Distribution

Radial power distribution is the preferred method of providing power to the load. Figure 26 shows how individual loads are connected directly to the power source. This arrangement requires additional power leads, but it avoids the voltage variation problems associated with the parallel power distribution technique.

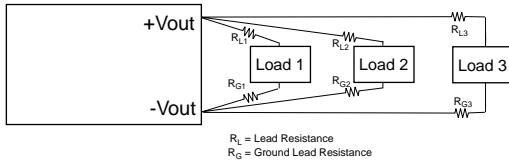

Fig.26 Radial Power Distribution

Mixed Distribution

In the real world a combination of parallel and radial power distribution is often used. Dynamic and high current loads are connected using a radial design, while static and low current loads can be connected in parallel. This combined approach minimizes the drawbacks of a parallel design when a purely radial design is not feasible.

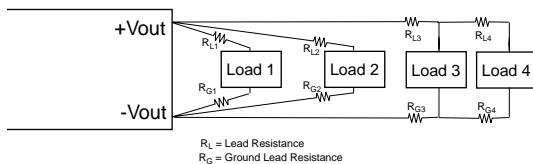

Fig.27 Mixed Power Distribution

Thermal Management

Technologies

AV60A dual output series modules feature high efficiency, the 5V/3.3 V output units have typical efficiency of 82% at full load, and the 3.3V/2.5V output units have typical efficiency of 80% at full load. With less heat dissipation and temperature-resistant components such as ceramic capacitors, these modules exhibit good behavior during prolonged exposure to high temperatures. Maintaining the operating case temperature (Tc) within the specified range help keep internal-component temperatures within their specifications which in turn help keep MTBF from falling below the specified rating. Proper cooling of the power modules is also necessary for reliable and consistent operation.

Basic Thermal Management

Measuring the case temperature of the module (Tc) as the method shown in Figure 28 can verify the proper cooling. Figure 28 shows the metal surface of the module and the pin locations. The module should work under 90°C for the reliability of operation and Tc must not exceed 100 °C while operating in the final system configuration. The measurement can be made with a surface probe after the module has reached thermal equilibrium. If a heat sink is mounted to the case, make the measurement as close as possible to the indicated position. It makes the assumption that the final system configuration exists and can be used for a test environment.

The following text and graphs show guidelines to predict the thermal performance of the module for typical configurations that include heat sinks in natural or forced airflow environments. Note that Tc of module must always be checked

**AV60A DUAL OUTPUT HALF-BRICK POWER CONVERTERS
36VDC TO 75VDC INPUT, 75 WATT OUTPUT**

in the final system configuration to verify proper operational due to the variation in test conditions.

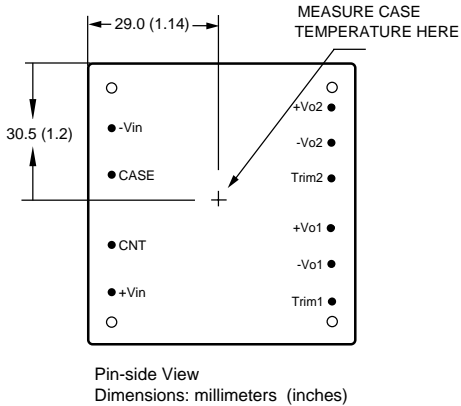

Fig.28 Case Temperature Measurement (component-side footprint)

Thermal management acts to transfer the heat dissipated by the module to the surrounding environment. The amount of power dissipated by the module as heat (P_D) is got by the equation below:

$$P_D = P_i - P_o$$

where : P_i is input power;

P_o is output power;

P_D is dissipated power.

Also, module efficiency (η) is defined as the following equation:

$$\eta = P_o / P_i$$

If eliminating the input power term, from two above equations can yield the equation below:

$$P_D = P_o (1 - \eta) / \eta$$

The module power dissipation then can be calculated through the equation.

Because each power module output voltage has a different power dissipation curve, a plot of power dissipation versus output current over three different line voltages is given in each module-specific data sheet. The typical power dissipation curves of AV60A series are shown as figure 29 to figure 32.

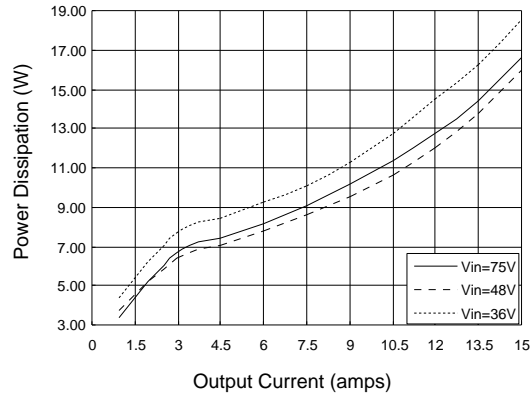

Fig.29 AV60A-048L-050D033(N) Power Dissipation Curves, 5V:load variable, 3.3V:no load

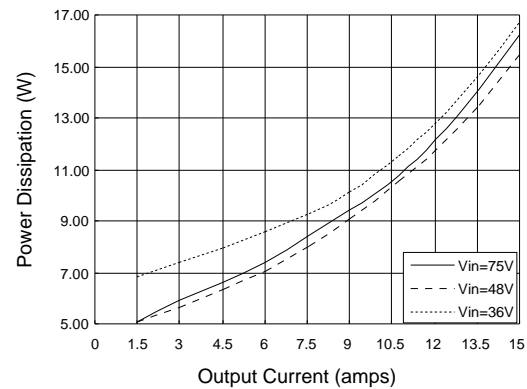

Fig.30 AV60A-048L-050D033(N) Power Dissipation Curves, 5V@1.5A, 3.3V:load variable

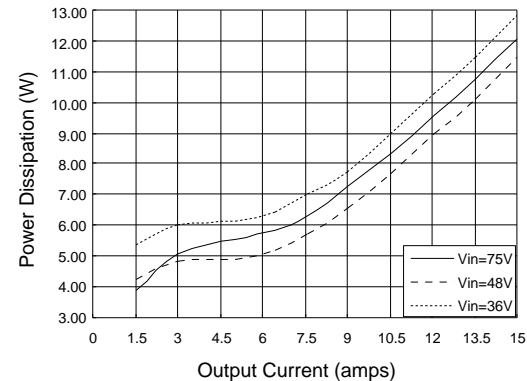

Fig.31 AV60A-048L-033D025(N) Power Dissipation Curves, 3.3V:load variable, 2.5V:no load

**AV60A DUAL OUTPUT HALF-BRICK POWER CONVERTERS
36VDC TO 75VDC INPUT, 75 WATT OUTPUT**

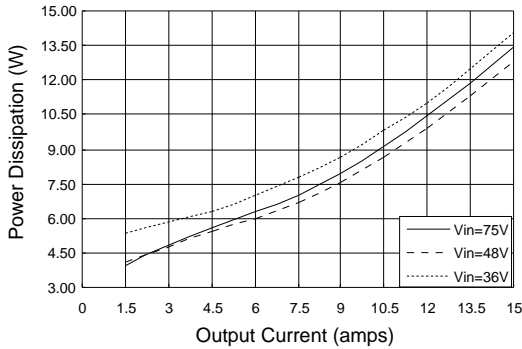

Fig.32 AV60A-048L-033D025(N) Power Dissipation Curves, 3.3V@1.5A, 2.5V:load variable

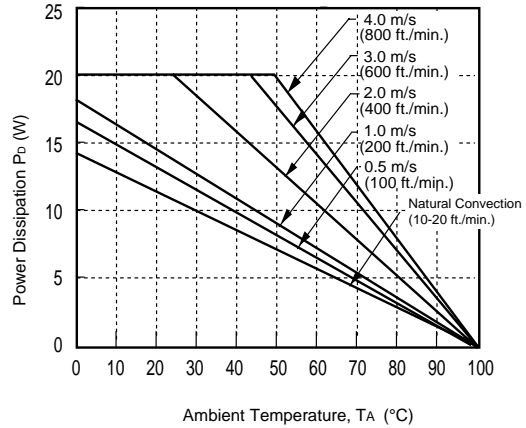

Fig.34 Forced Convection Power Derating without Heat Sink

Module Derating

Experiment Setup

From the experimental set up shown in figure 33, the derating curves as figure 34 can be drawn. Note that the PWB (printed-wiring board) and the module must be mounted vertically. The passage has a rectangular cross-section. The clearance between the facing PWB and the top of the module is kept 13 mm (0.5 in.) constantly.

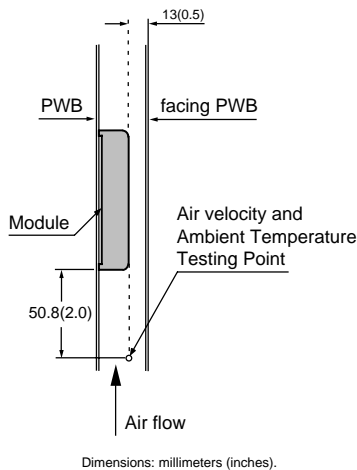

Fig.33 Experiment Set Up

Convection Without Heat Sinks

Heat transfer can be enhanced by increasing the airflow over the module. Figure 34 shows the maximum power that can be dissipated by the module.

In the test, natural convection airflow was measured at 0.05 m/s to 0.1 m/s (10 ft./min. to 20 ft./min.). The 0.5 m/s to 4.0 m/s (100 ft./min. to 800 ft./min.) curves are tested with externally adjustable fans. The appropriate airflow for a given operating condition can be determined through figure 34.

Example 1. How to calculate the minimum airflow required to maintain a desired Tc?

If a AV60A-048L-050D033(N) module operates with a 48V line voltage, a 15 A of I_{o2} , and a 40 °C maximum ambient temperature, What is the minimum airflow necessary for the operating?

Determine P_D (referenced Fig.30) with condition:

$$V_{in} = 48V, I_{o1} = 1.5A, I_{o2} = 15A$$

Get: $P_D = 15.5W$

From: $T_A = 40\text{ }^\circ\text{C}$

Determine airflow (Fig.34):

$$v = 2\text{ m/s (400 ft./min.)}$$

**AV60A DUAL OUTPUT HALF-BRICK POWER CONVERTERS
36VDC TO 75VDC INPUT, 75 WATT OUTPUT**

Example 2. How to calculate the maximum output power of a module in a certain convection and a max. TA?

What is the maximum power output for a AV60A-048L-050D033(N) operating at following conditions:

- $V_{in} = 48V$
- $v = 2.0 \text{ m/s (400 ft./min.)}$
- $T_A = 40 \text{ }^\circ\text{C}$

Determine P_D (Fig.34)

$P_D = 16 \text{ W}$

Determine I_o (Fig. 29):

$I_o = 14.5 \text{ A}$

Calculate P_o :

$P_o = (V_o) \times (I_o) = 5 \times 14.5 = 72.5 \text{ W}$

Although the two examples above use $100 \text{ }^\circ\text{C}$ as the maximum case temperature, for extremely high reliability applications, one may design to a lower case temperature as shown in Example 4 on page 22.

Heat Sink Configuration

Several standard heat sinks are available for the AV60A dual output modules as shown in Figure 35 to Figure 37.

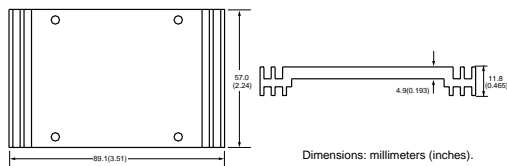

Fig.35 Non Standard Heatsink

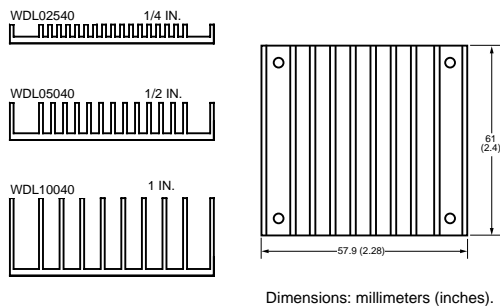
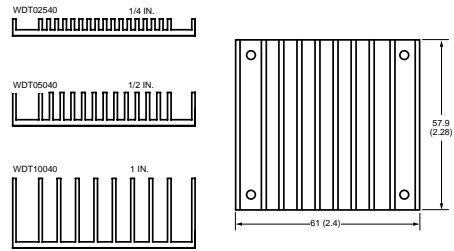

Fig.36 Longitudinal Fins Heat Sink



Dimensions: millimeters (inches).

Fig.37 Transverse Fins Heat Sink

The heat sinks mount to the top surface of the module with screws torqued to 0.56 N-m (5 in.-lb). A thermally conductive dry pad or thermal grease is placed between the case and the heat sink to minimize contact resistance (typically 0.1°C/W to 0.3°C/W) and temperature differential.

Nomenclature for heat sink configurations is as follows:

$WDxyyy40$

where:

x = fin orientation: longitudinal (L) or transverse (T)

yyy = heat sink height (in 100ths of inch)

For example, WDT5040 is a heat sink that is transverse mounted (see Figure 25) for a 61 mm x 57.9 mm (2.4 in.x 2.28 in.) module with a heat sink height of 0.5 in.

Heatsink Mounting Advice

A crucial part of the thermal design strategy is the thermal interface between the baseplate of the module and the heatsink. Inadequate measures taken here will quickly negate any other attempts to control the baseplate temperature. For example, using a conventional dry insulator can result in a case-heatsink thermal impedance of $>0.5^\circ\text{C/W}$, while use one of the recommended interface methods (silicon grease or thermal pads available from ASTEC) can result in a case-heatsink thermal impedance around 0.1°C/W .

**AV60A DUAL OUTPUT HALF-BRICK POWER CONVERTERS
36VDC TO 75VDC INPUT, 75 WATT OUTPUT**

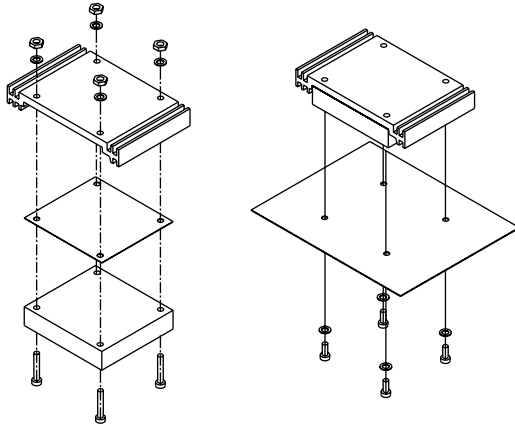

Fig.38 Heat Sink Mounting

Natural Convection with Heat Sink

The power derating for a module with the heat sinks (shown as figure 35 to figure 37) in natural convection is shown in figure 39. In this test, nature convection generates airflow about 0.05 m/s to 0.1 m/s (10ft./min to 20ft./min).

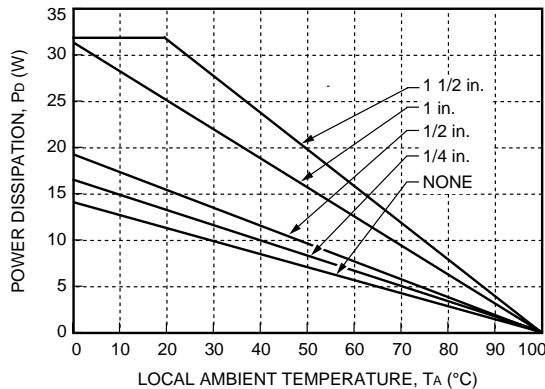

Fig.39 Heat Sink Power Derating Curves, Natural Convection

Figure 39 can be used for heat-sink selection in natural convection environment.

Example 3. How to select a heat sink?

What heat sink would be appropriate for a AV60A-048L-033D025(N) in a natural convection environment at nominal line, full load, and maximum ambient temperature of 40°C?

Determine Pd (referenced Fig.31) with condition:

$V_{in} = 48 \text{ V}$

$I_o = 15 \text{ A}$

$T_A = 40 \text{ }^\circ\text{C}$

Get: $P_D = 11.5 \text{ W}$

Determine Heat Sink (Fig.39):

1/2 in. allows up to $T_A = 40 \text{ }^\circ\text{C}$

Basic Thermal Model

There is another approach to analyze module thermal performance, to model the overall thermal resistance of the module. This presentation method is especially useful when considering heat sinks. The following equation can be used to calculate the total thermal resistance .

$R_{CA} = \Delta T_{C, \text{max}} / P_D$

Where R_{CA} is the total module thermal resistance.

$\Delta T_{C, \text{max}}$ is the maximum case temperature rise.

P_D is the module power dissipation.

In this model, P_D , $\Delta T_{C, \text{max}}$, and R_{CA} are equals to current flow, voltage drop, and electrical resistance, respectively, in Ohm's law, as shown in Figure 40. Also, $\Delta T_{C, \text{max}}$ is defined as the difference between the module case temperature (T_C) and the inlet ambient temperature (T_A).

$\Delta T_{C, \text{max}} = T_C - T_A$

Where T_C is the module case temperature;

T_A is the inlet ambient temperature.

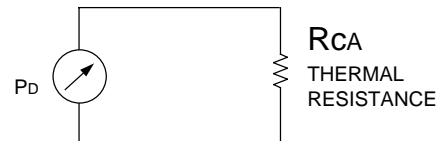

Fig.40 Basic Thermal Resistance Model

For AV60A dual output series converters, the module's thermal resistance values versus air

**AV60A DUAL OUTPUT HALF-BRICK POWER CONVERTERS
36VDC TO 75VDC INPUT, 75 WATT OUTPUT**

velocity have been determined experimentally and shown in figure 41. The highest values on each curve represents the point of natural convection.

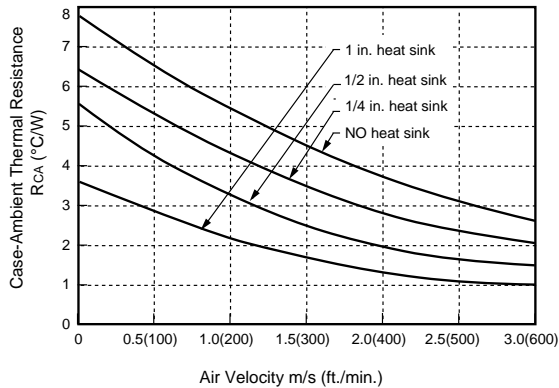

Fig.41 Case-to-Ambient Thermal Resistance Curves; Either Orientation

Figure 41 is used for determining thermal performance under various conditions of airflow and heat sink configurations.

Example 4. How to determine the allowable minimum airflow to heat sink combinations necessary for a module under a desired Tc and a certain condition?

Although the maximum case temperature for the AV60A dual output series converters is 100°C, you can improve module reliability by limiting Tc,max to a lower value. How to decide? For example, what is the allowable minimum airflow for AV60A-048L-050D033(N) heat sink combinations at desired Tc of 80 °C?

The working condition is as following:

- Vin = 48V
- Io1 = 1.5 A
- Io2 = 13.5 A
- TA = 40 °C.

Determine Pd (Fig.30)

$P_D = 13.5 \text{ W}$

Then solve RCA:

$RCA = \Delta T_{C, \max} / P_D$

$RCA = (T_C - T_A) / P_D$

$RCA = (80 - 40) / 13.5 = 3 \text{ } ^\circ\text{C/W}$

determine air velocity from figure 41:

If no heat sink:

$v = 2.7 \text{ m/s (540 ft./min.)}$

If 1/4 in. heat sink:

$v = 1.9 \text{ m/s (380 ft./min.)}$

If 1/2 in. heat sink:

$v = 1.2 \text{ m/s (24 ft./min.)}$

If 1 in. heat sink:

$v = 0.4 \text{ m/s (80 ft./min.)}$

Example 5. How to determine case temperature (Tc) for the various heat sink configurations at certain air velocity?

What is the allowable Tc for AV60A-048L-033D025(N) heat sink configurations at desired air velocity of 2.0 m/s, and it is operating at a 48 V line voltage, a total output current of 15A, a 40 °C maximum ambient temperature?

Determine Pd (Fig. 32.) with condition:

- Vi = 48V
- Io1 = 1.5 A, Io2 = 13.5 A
- TA = 40 °C
- v = 2.0 m/s (400 ft./min.)

Get: Pd = 11.5 W

Determine Tc: $T_C = (RCA \times P_D) + T_A$

Determine the corresponding thermal resistances (RCA) from Figure 41:

- No heat sink: RCA = 3.8 °C/W
 $T_C = (3.8 \times 11.5) + 40 = 83.7 \text{ } ^\circ\text{C}$
- 1/4 in. heat sink: RCA = 2.8 °C/W
 $T_C = (2.8 \times 11.5) + 40 = 72.2 \text{ } ^\circ\text{C}$
- 1/2 in. heat sink: RCA = 2.0 °C/W
 $T_C = (2 \times 11.5) + 40 = 63 \text{ } ^\circ\text{C}$
- 1 in. heat sink: RCA = 1.2 °C/W
 $T_C = (1.2 \times 11.5) + 40 = 53.8 \text{ } ^\circ\text{C}$

In this configuration, the module does not need the heat sink and the power module does not exceed the maximum case temperature of 100°C.

**AV60A DUAL OUTPUT HALF-BRICK POWER CONVERTERS
36VDC TO 75VDC INPUT, 75 WATT OUTPUT**

Mechanical Considerations

Installation

Although AV60A dual output converters can be mounted in any orientation, free air-flowing must be taken. Normally power components are always put at the end of the airflow path or have the separate airflow paths. This can keep other system equipment cooler and increase component life spans.

Soldering

AV60A dual output converters are compatible with standard wave soldering techniques. When wave soldering, the converter pins should be preheated for 20-30 seconds at 110°C, and wave soldered at 260°C for less than 15 seconds.

When hand soldering, the iron temperature should be maintained at 450°C and applied to the converter pins for less than 5 seconds.

Longer exposure can cause internal damage to the converter. Cleaning can be performed with cleaning solvent IPA or with water.

MTBF

The MTBF, calculated in accordance with Bellcore TR-NWT-000332 is 2,300,000 hours. Obtaining this MTBF in practice is entirely possible. It means providing forced air cooling of at least 300 LFM. If the ambient air temperature is expected to exceed +25°C, then we also advise a heatsink on the AV60A series, oriented for the best possible cooling in the air stream.

ASTEC can supply replacements for converters from other manufacturers, or offer custom solutions. Please contact the factory for details.

Mechanical Chart (baseplate-side footprint)

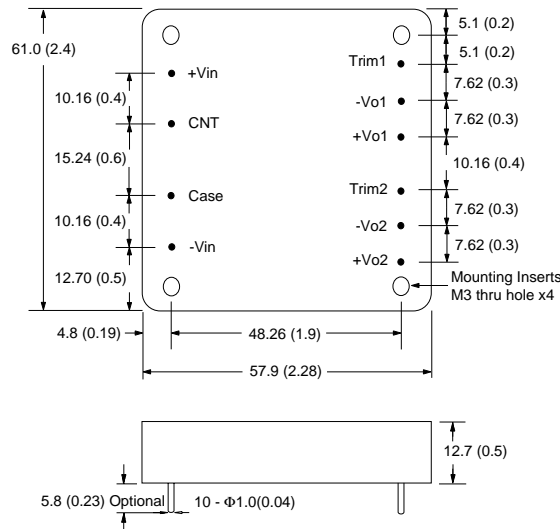

Pin Length Option	Device Code Suffix
3.80mm ± 0.25mm 0.150in. ± 0.010in.	-6
2.80mm ± 0.25mm 0.110in. ± 0.010in.	-8
5.8mm ± 0.5mm 0.228in. ± 0.020in.	-7

mm (inches)

Tolerances:
Inches: .xx ±0.020 .x ±0.5 .xxx ±0.010 .xx ±0.25
Millimeters

Pins
>4mm ±0.02inch (±0.5mm)
<4mm ±0.01inch (±0.25mm)

PART NUMBER DESCRIPTION

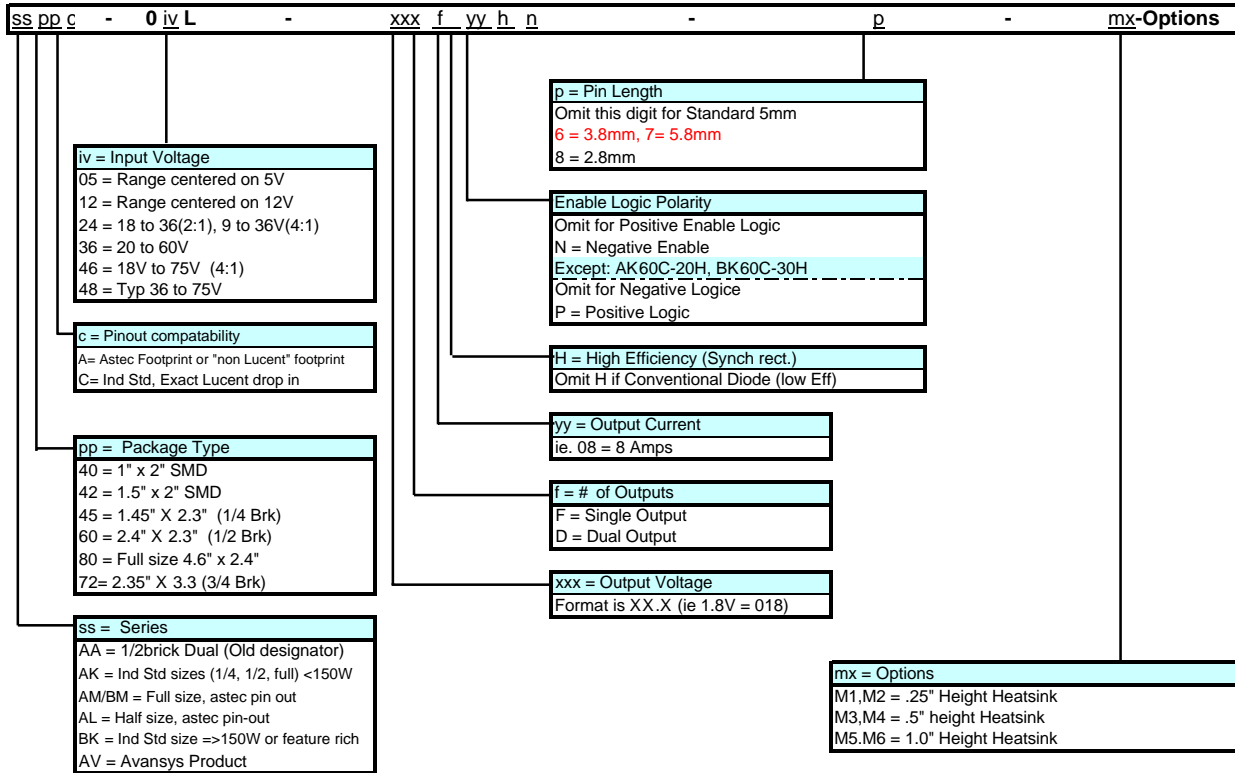

Note: For some products, they may not conform with the PART NUMBER DESCRIPTION above absolutely.

NEW PART NUMBER DESCRIPTION

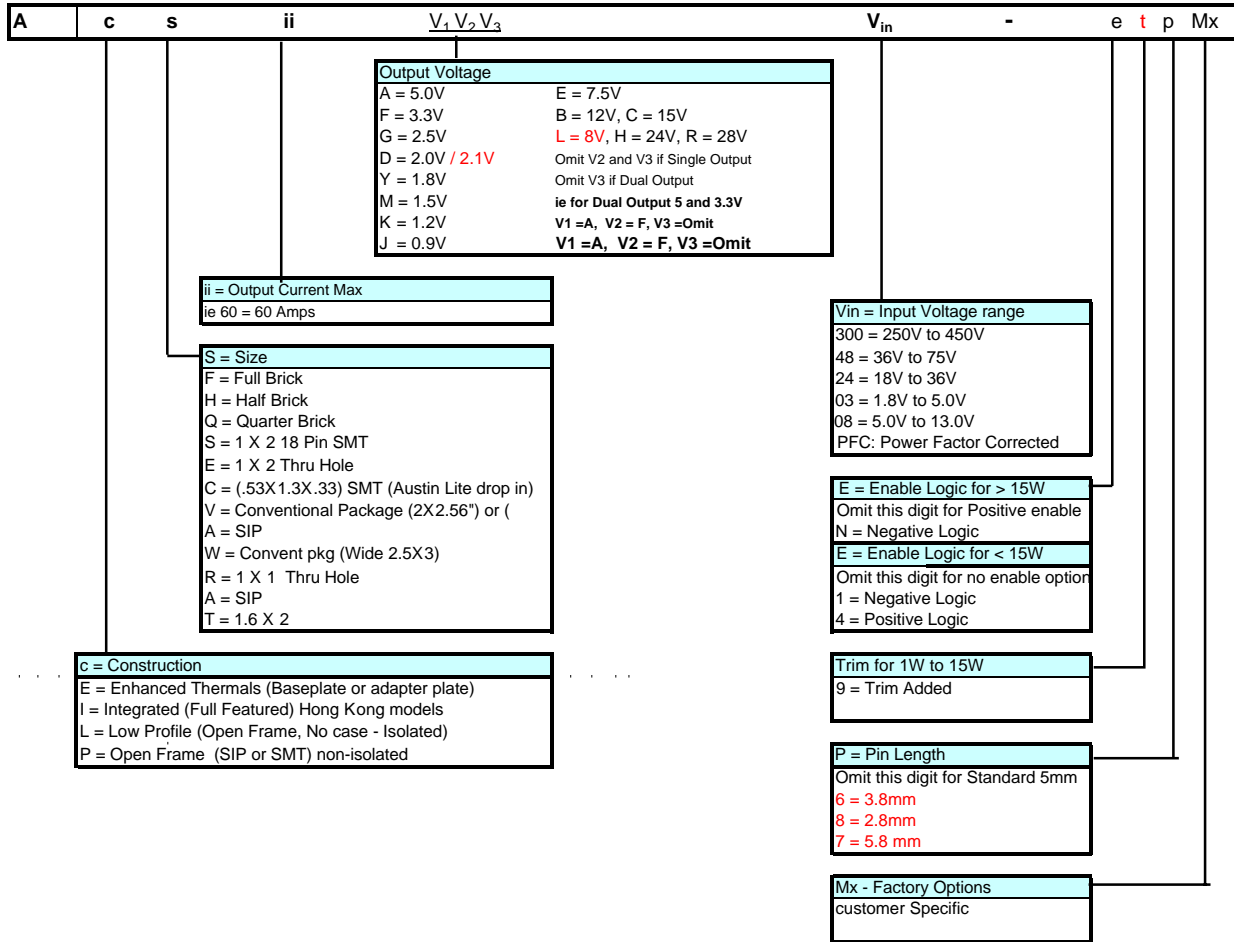

Note: For some products, they may not conform with the NEW PART NUMBER DESCRIPTION above absolutely.