

# CAT28C64B

## 64K-Bit CMOS E<sup>2</sup>PROM

### FEATURES

- **Fast Read Access Times:**
  - 120/150/200ns
- **Low Power CMOS Dissipation:**
  - Active: 25 mA Max.
  - Standby: 100  $\mu$ A Max.
- **Simple Write Operation:**
  - On-Chip Address and Data Latches
  - Self-Timed Write Cycle with Auto-Clear
- **Fast Write Cycle Time:**
  - 5ms Max. (3ms available)
- **CMOS and TTL Compatible I/O**
- **Commerical and Industrial Temperature Ranges**
- **Automatic Page Write Operation:**
  - 1 to 32 Bytes in 5ms
  - Page Load Timer
- **End of Write Detection:**
  - Toggle Bit
  - DATA Polling
- **Hardware and Software Write Protection**
- **100,000 Program/Erase Cycles**
- **100 Year Data Retention**

### DESCRIPTION

The CAT28C64B is a fast, low power, 5V-only CMOS E<sup>2</sup>PROM organized as 8K x 8-bits. It requires a simple interface for in-system programming. On-chip address and data latches, self-timed write cycle with auto-clear and V<sub>CC</sub> power up/down write protection eliminate additional timing and protection hardware. DATA Polling and Toggle status bits signal the start and end of the self-timed write cycle. Additionally, the CAT28C64B features hardware and software write protection.

The CAT28C64B is manufactured using Catalyst's advanced CMOS floating gate technology. It is designed to endure 100,000 program/erase cycles and has a data retention of 100 years. The device is available in JEDEC-approved 28-pin DIP, TSOP and SOIC, or, 32-pin PLCC and TSOP packages.

### BLOCK DIAGRAM

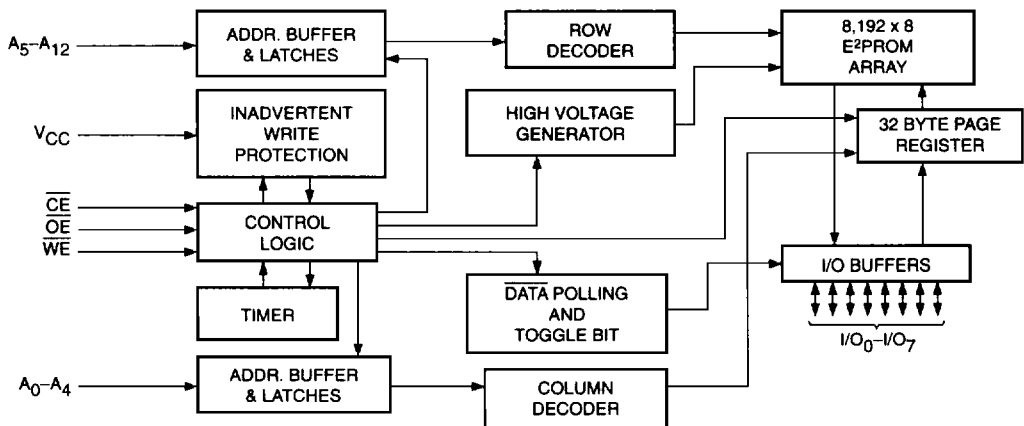

5094 FHD F02

**PIN CONFIGURATION**

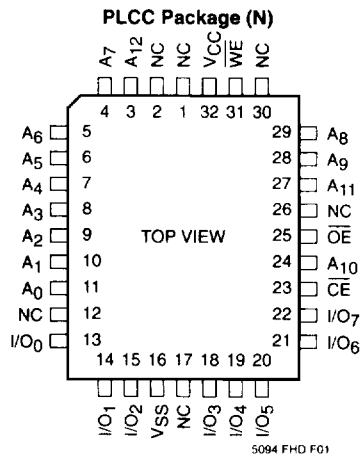
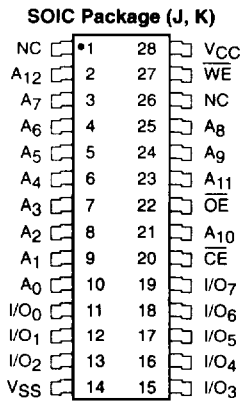
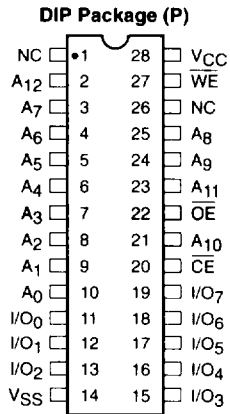

**PIN FUNCTIONS**

Pin Name	Function
A <sub>0</sub> -A <sub>12</sub>	Address Inputs
I/O <sub>0</sub> -I/O <sub>7</sub>	Data Inputs/Outputs
CE	Chip Enable
OE	Output Enable
WE	Write Enable
VCC	5V Supply
VSS	Ground
NC	No Connect

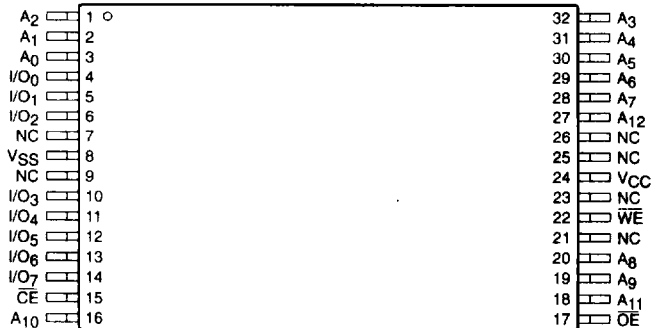

**TSOP Package (8mm x 14mm) (T14)**  
**TSOP Package (8mm x 20mm) (T)**

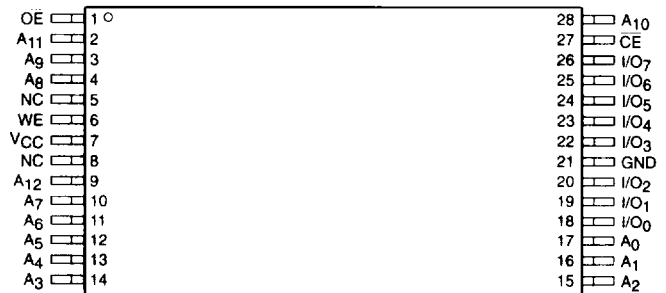

**TSOP Package (8mm x 13.4mm) (T13)**



## MODE SELECTION

Mode	$\overline{\text{CE}}$	$\overline{\text{WE}}$	$\overline{\text{OE}}$	I/O	Power
Read	L	H	L	D <sub>OUT</sub>	ACTIVE
Byte Write ( $\overline{\text{WE}}$ Controlled)	L		H	D <sub>IN</sub>	ACTIVE
Byte Write ( $\overline{\text{CE}}$ Controlled)		L	H	D <sub>IN</sub>	ACTIVE
Standby, and Write Inhibit	H	X	X	High-Z	STANDBY
Read and Write Inhibit	X	H	H	High-Z	ACTIVE

CAPACITANCE  $T_A = 25^\circ\text{C}$ ,  $f = 1.0\text{ MHz}$ ,  $V_{CC} = 5\text{V}$ 

Symbol	Test	Max.	Units	Conditions
$C_{I/O}^{(1)}$	Input/Output Capacitance	10	pF	$V_{I/O} = 0\text{V}$
$C_{IN}^{(1)}$	Input Capacitance	6	pF	$V_{IN} = 0\text{V}$

## ABSOLUTE MAXIMUM RATINGS\*

Temperature Under Bias .....	$-55^\circ\text{C}$ to $+125^\circ\text{C}$
Storage Temperature .....	$-65^\circ\text{C}$ to $+150^\circ\text{C}$
Voltage on Any Pin with Respect to Ground <sup>(2)</sup> .....	$-2.0\text{V}$ to $+V_{CC} + 2.0\text{V}$
$V_{CC}$ with Respect to Ground .....	$-2.0\text{V}$ to $+7.0\text{V}$
Package Power Dissipation Capability ( $T_A = 25^\circ\text{C}$ ) .....	1.0W
Lead Soldering Temperature (10 secs) .....	$300^\circ\text{C}$
Output Short Circuit Current <sup>(3)</sup> .....	100 mA

## \*COMMENT

Stresses above those listed under "Absolute Maximum Ratings" may cause permanent damage to the device. These are stress ratings only, and functional operation of the device at these or any other conditions outside of those listed in the operational sections of this specification is not implied. Exposure to any absolute maximum rating for extended periods may affect device performance and reliability.

8

## RELIABILITY CHARACTERISTICS

Symbol	Parameter	Min.	Max.	Units	Test Method
$N_{END}^{(1)}$	Endurance	$10^4$ or $10^5$		Cycles/Byte	MIL-STD-883, Test Method 1033
$T_{DR}^{(1)}$	Data Retention	100		Years	MIL-STD-883, Test Method 1008
$V_{ZAP}^{(1)}$	ESD Susceptibility	2000		Volts	MIL-STD-883, Test Method 3015
$I_{LTH}^{(1)(4)}$	Latch-Up	100		mA	JEDEC Standard 17

## Note:

- (1) This parameter is tested initially and after a design or process change that affects the parameter.
- (2) The minimum DC input voltage is  $-0.5\text{V}$ . During transitions, inputs may undershoot to  $-2.0\text{V}$  for periods of less than 20 ns. Maximum DC voltage on output pins is  $V_{CC} + 0.5\text{V}$ , which may overshoot to  $V_{CC} + 2.0\text{V}$  for periods of less than 20 ns.
- (3) Output shorted for no more than one second. No more than one output shorted at a time.
- (4) Latch-up protection is provided for stresses up to 100mA on address and data pins from  $-1\text{V}$  to  $V_{CC} + 1\text{V}$ .

**D.C. OPERATING CHARACTERISTICS**

V<sub>CC</sub> = 5V ±10%, unless otherwise specified.

Symbol	Parameter	Limits			Units	Test Conditions
		Min.	Typ.	Max.		
I <sub>CC</sub>	V <sub>CC</sub> Current (Operating, TTL)			30	mA	$\overline{CE} = \overline{OE} = V_{IL}$ , f = 1/t <sub>RC</sub> min, All I/O's Open
I <sub>CC</sub> <sup>(1)</sup>	V <sub>CC</sub> Current (Operating, CMOS)			25	mA	$\overline{CE} = \overline{OE} = V_{ILC}$ , f = 1/t <sub>RC</sub> min, All I/O's Open
I <sub>SB</sub>	V <sub>CC</sub> Current (Standby, TTL)			1	mA	$\overline{CE} = V_{IH}$ , All I/O's Open
I <sub>SBC</sub> <sup>(2)</sup>	V <sub>CC</sub> Current (Standby, CMOS)			100	μA	$\overline{CE} = V_{IHC}$ , All I/O's Open
I <sub>LI</sub>	Input Leakage Current	-10		10	μA	V <sub>IN</sub> = GND to V <sub>CC</sub>
I <sub>LO</sub>	Output Leakage Current	-10		10	μA	V <sub>OUT</sub> = GND to V <sub>CC</sub> , $\overline{CE} = V_{IH}$
V <sub>IH</sub> <sup>(2)</sup>	High Level Input Voltage	2		V <sub>CC</sub> +0.3	V	
V <sub>IL</sub> <sup>(1)</sup>	Low Level Input Voltage	-0.3		0.8	V	
V <sub>OH</sub>	High Level Output Voltage	2.4			V	I <sub>OH</sub> = -400μA
V <sub>OL</sub>	Low Level Output Voltage			0.4	V	I <sub>OL</sub> = 2.1mA
V <sub>WI</sub>	Write Inhibit Voltage	3.5			V	

Note:

(1) V<sub>ILC</sub> = -0.3V to +0.3V.

(2) V<sub>IHC</sub> = V<sub>CC</sub> -0.3V to V<sub>CC</sub> +0.3V.

**A.C. CHARACTERISTICS, Read Cycle**

V<sub>CC</sub> = 5V ±10%, unless otherwise specified.

Symbol	Parameter	28C64B-12		28C64B-15		28C64B-20		Units
		Min.	Max.	Min.	Max.	Min.	Max.	
t <sub>RC</sub>	Read Cycle Time	120		150		200		ns
t <sub>CE</sub>	$\overline{OE}$ Access Time		120		150		200	ns
t <sub>AA</sub>	Address Access Time		120		150		200	ns
t <sub>OE</sub>	$\overline{OE}$ Access Time		60		70		80	ns
t <sub>LZ</sub> <sup>(1)</sup>	$\overline{OE}$ Low to Active Output	0		0		0		ns
t <sub>OLZ</sub> <sup>(1)</sup>	$\overline{OE}$ Low to Active Output	0		0		0		ns
t <sub>HZ</sub> <sup>(1)(2)</sup>	$\overline{OE}$ High to High-Z Output		50		50		55	ns
t <sub>OHZ</sub> <sup>(1)(2)</sup>	$\overline{OE}$ High to High-Z Output		50		50		55	ns
t <sub>OH</sub> <sup>(1)</sup>	Output Hold from Address Change	0		0		0		ns

**Figure 1. A.C. Testing Input/Output Waveform(3)**

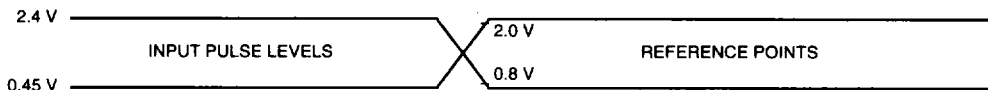

5096 FHD F03

**Figure 2. A.C. Testing Load Circuit (example)**

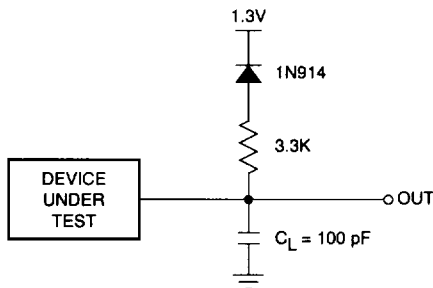

C<sub>L</sub> INCLUDES JIG CAPACITANCE

5096 FHD F04

**Note:**

- (1) This parameter is tested initially and after a design or process change that affects the parameter.
- (2) Output floating (High-Z) is defined as the state when the external data line is no longer driven by the output buffer.
- (3) Input rise and fall times (10% and 90%) < 10 ns.

**A.C. CHARACTERISTICS, Write Cycle**

V<sub>CC</sub> = 5V ±10%, unless otherwise specified.

Symbol	Parameter	28C64B-12		28C64B-15		28C64B-20		Units
		Min.	Max.	Min.	Max.	Min.	Max.	
t <sub>wc</sub>	Write Cycle Time		5		5		5	ms
t <sub>AS</sub>	Address Setup Time	0		0		0		ns
t <sub>AH</sub>	Address Hold Time	100		100		100		ns
t <sub>CS</sub>	$\overline{CE}$ Setup Time	0		0		0		ns
t <sub>CH</sub>	$\overline{CE}$ Hold Time	0		0		0		ns
t <sub>cw</sub> <sup>(2)</sup>	$\overline{CE}$ Pulse Time	110		110		110		ns
t <sub>OES</sub>	$\overline{OE}$ Setup Time	0		0		0		ns
t <sub>OEH</sub>	$\overline{OE}$ Hold Time	0		0		0		ns
t <sub>wp</sub> <sup>(2)</sup>	$\overline{WE}$ Pulse Width	110		110		110		ns
t <sub>DS</sub>	Data Setup Time	60		60		60		ns
t <sub>DH</sub>	Data Hold Time	0		0		0		ns
t <sub>INIT</sub> <sup>(1)</sup>	Write Inhibit Period After Power-up	5	10	5	10	5	10	ms
t <sub>BLC</sub> <sup>(1)(3)</sup>	Byte Load Cycle Time	.05	100	.05	100	.05	100	μs



Note:

- (1) This parameter is tested initially and after a design or process change that affects the parameter.
- (2) A write pulse of less than 20ns duration will not initiate a write cycle.
- (3) A timer of duration t<sub>BLC</sub> max. begins with every LOW to HIGH transition of  $\overline{WE}$ . If allowed to time out, a page or byte write will begin; however a transition from HIGH to LOW within t<sub>BLC</sub> max. stops the timer.

**DEVICE OPERATION**

**Read**

Data stored in the CAT28C64B is transferred to the data bus when  $\overline{WE}$  is held high, and both  $\overline{OE}$  and  $\overline{CE}$  are held low. The data bus is set to a high impedance state when either  $\overline{CE}$  or  $\overline{OE}$  goes high. This 2-line control architecture can be used to eliminate bus contention in a system environment.

**Byte Write**

A write cycle is executed when both  $\overline{CE}$  and  $\overline{WE}$  are low, and  $\overline{OE}$  is high. Write cycles can be initiated using either  $\overline{WE}$  or  $\overline{CE}$ , with the address input being latched on the falling edge of  $\overline{WE}$  or  $\overline{CE}$ , whichever occurs last. Data, conversely, is latched on the rising edge of  $\overline{WE}$  or  $\overline{CE}$ , whichever occurs first. Once initiated, a byte write cycle automatically erases the addressed byte and the new data is written within 5 ms.

**Figure 3. Read Cycle**

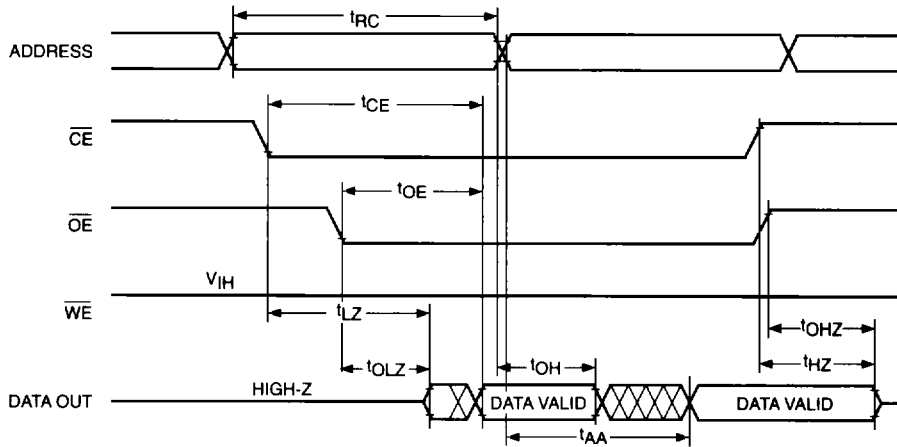

28C64B F06

**Figure 4. Byte Write Cycle [ $\overline{WE}$  Controlled]**

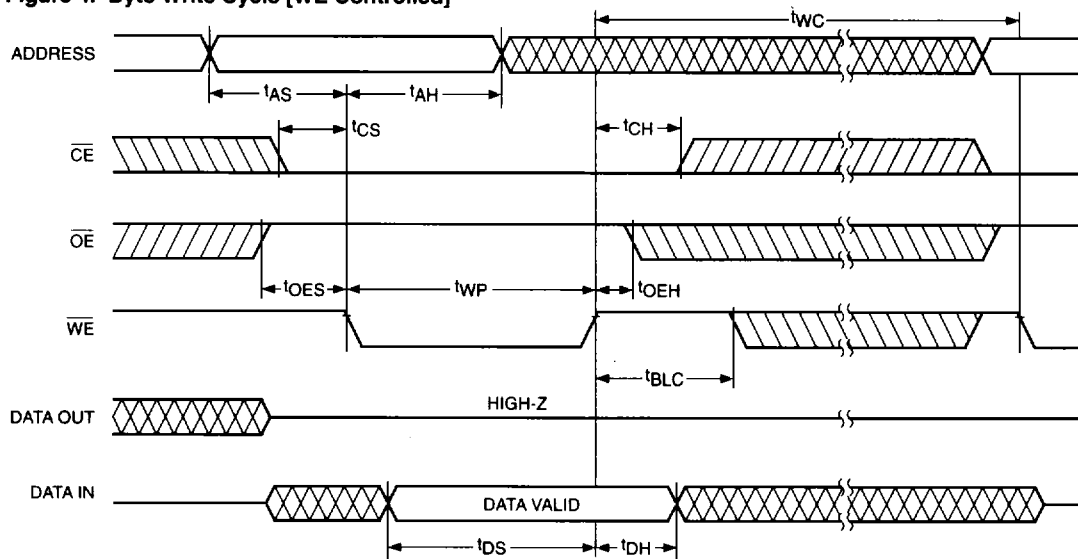

5096 FHD F06

**Page Write**

The page write mode of the CAT28C64B (essentially an extended BYTE WRITE mode) allows from 1 to 32 bytes of data to be programmed with a single E<sup>2</sup>PROM write cycle. This effectively reduces the byte-write time by a factor of 32.

Following an initial WRITE operation ( $\overline{WE}$  pulsed low, for  $t_{WP}$ , and then high) the page write mode can begin by issuing sequential  $\overline{WE}$  pulses, which load the address and data bytes into a 32 byte temporary buffer. The page address where data is to be written, specified by bits A<sub>5</sub> to A<sub>12</sub>, is latched on the last falling edge of  $\overline{WE}$ . Each byte within the page is defined by address bits A<sub>0</sub> to A<sub>4</sub>

(which can be loaded in any order) during the first and subsequent write cycles. Each successive byte load cycle must begin within  $t_{BLC\ MAX}$  of the rising edge of the preceding  $\overline{WE}$  pulse. There is no page write window limitation as long as  $\overline{WE}$  is pulsed low within  $t_{BLC\ MAX}$ .

Upon completion of the page write sequence,  $\overline{WE}$  must stay high a minimum of  $t_{BLC\ MAX}$  for the internal automatic program cycle to commence. This programming cycle consists of an erase cycle, which erases any data that existed in each addressed cell, and a write cycle, which writes new data back into the cell. A page write will only write data to the locations that were addressed and will not rewrite the entire page.

**Figure 5. Byte Write Cycle [ $\overline{CE}$  Controlled]**

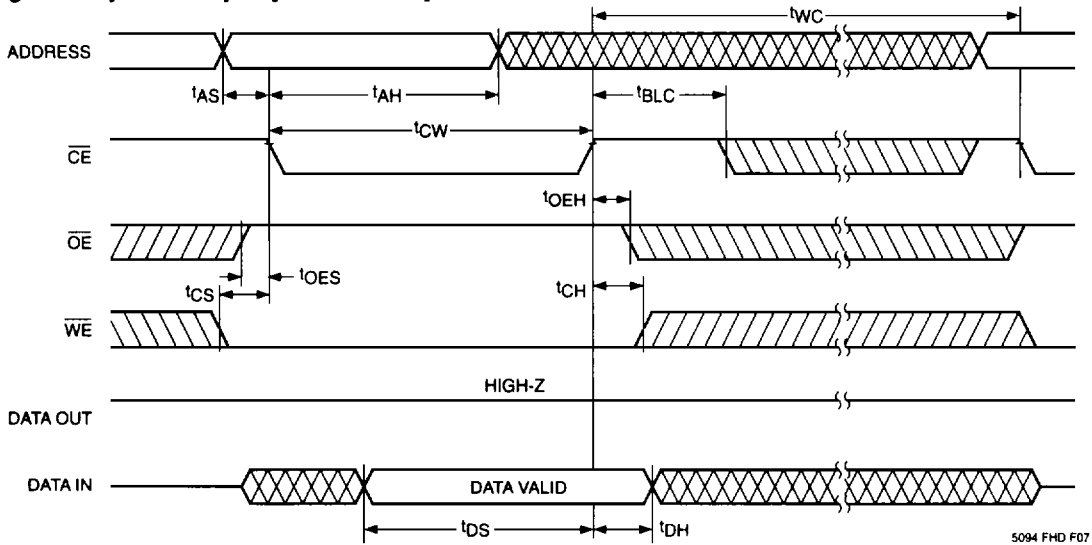

**Figure 6. Page Mode Write Cycle**

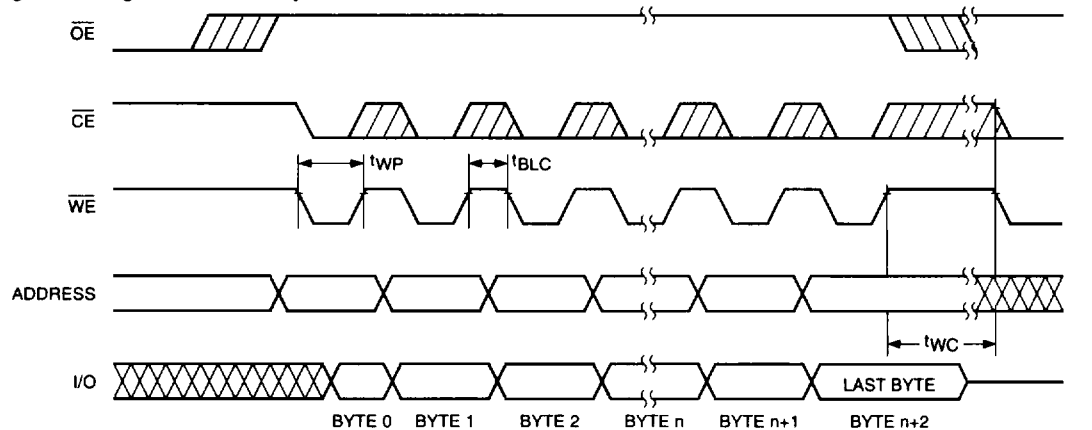



**DATA Polling**

DATA polling is provided to indicate the completion of write cycle. Once a byte write or page write cycle is initiated, attempting to read the last byte written will output the complement of that data on I/O<sub>7</sub> (I/O<sub>0</sub>–I/O<sub>6</sub> are indeterminate) until the programming cycle is complete. Upon completion of the self-timed write cycle, all I/O's will output true data during a read cycle.

**Toggle Bit**

In addition to the DATA Polling feature, the device offers an additional method for determining the completion of a write cycle. While a write cycle is in progress, reading data from the device will result in I/O<sub>6</sub> toggling between one and zero. However, once the write is complete, I/O<sub>6</sub> stops toggling and valid data can be read from the device.

**Figure 7. DATA Polling**

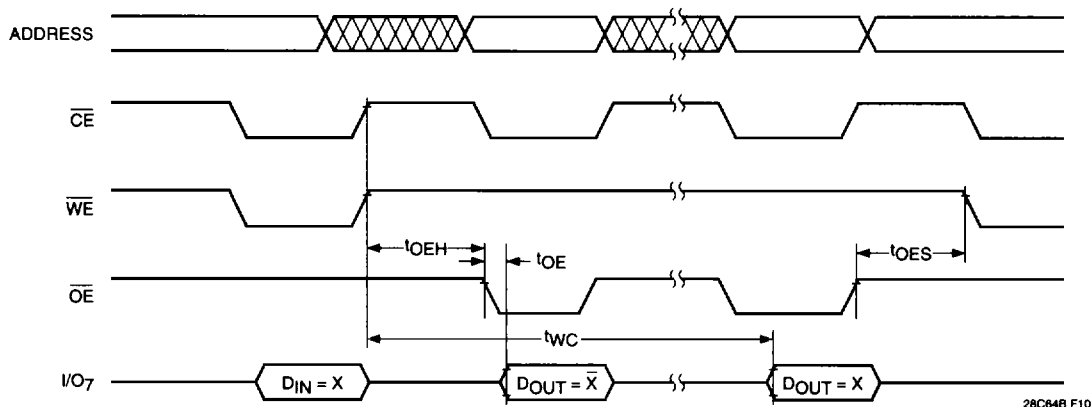

28C64B F10

**Figure 8. Toggle Bit**

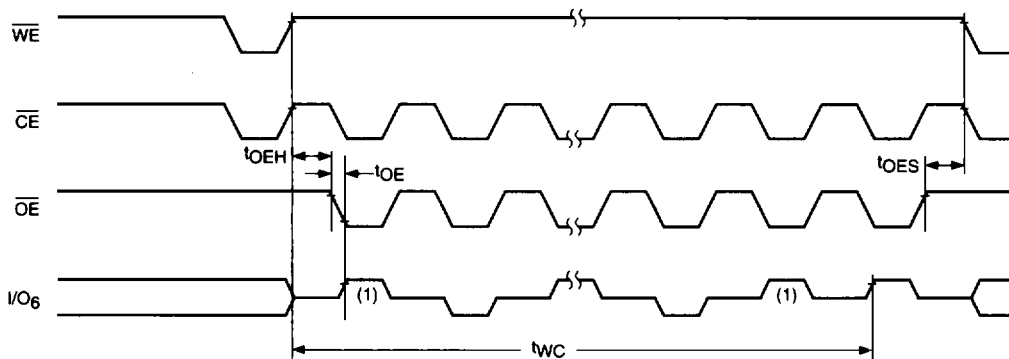

28C64B F11

Note:

- (1) Beginning and ending state of I/O<sub>6</sub> is indeterminate.

**HARDWARE DATA PROTECTION**

The following is a list of hardware data protection features that are incorporated into the CAT28C64B.

- (1) V<sub>CC</sub> sense provides for write protection when V<sub>CC</sub> falls below 3.5V min.
- (2) A power on delay mechanism, t<sub>INIT</sub> (see AC characteristics), provides a 5 to 10 ms delay before a write sequence, after V<sub>CC</sub> has reached 3.5V min.
- (3) Write inhibit is activated by holding any one of  $\overline{OE}$  low,  $\overline{CE}$  high or  $\overline{WE}$  high.

- (4) Noise pulses of less than 20 ns on the  $\overline{WE}$  or  $\overline{CE}$  inputs will not result in a write cycle.

**SOFTWARE DATA PROTECTION**

The CAT28C64B features a software controlled data protection scheme which, once enabled, requires a data algorithm to be issued to the device before a write can be performed. The device is shipped from Catalyst with the software protection NOT ENABLED (the CAT28C64B is in the standard operating mode).

**Figure 9. Write Sequence for Activating Software Data Protection**

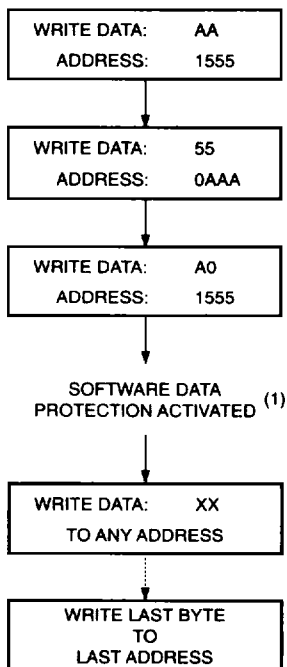

5094 FHD F08

**Figure 10. Write Sequence for Deactivating Software Data Protection**

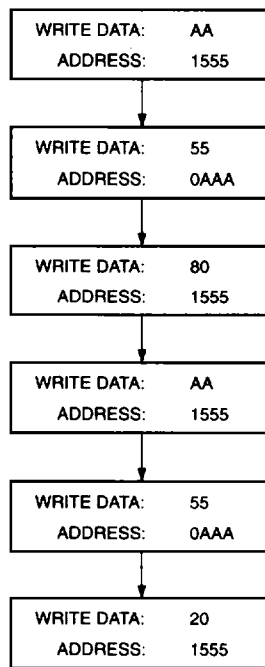

5094 FHD F09

Note:

- (1) Write protection is activated at this point whether or not any more writes are completed. Writing to addresses must occur within t<sub>BLC</sub> Max., after SDP activation.

To activate the software data protection, the device must be sent three write commands to specific addresses with specific data (Figure 9). This sequence of commands (along with subsequent writes) must adhere to the page write timing specifications (Figure 11). Once this is done, all subsequent byte or page writes to the device must be preceded by this same set of write commands. The data protection mechanism is activated until a deactivate sequence is issued regardless of power on/off transitions. This gives the user added inadvertent write protection on power-up in addition to the hardware protection provided.

To allow the user the ability to program the device with an E<sup>2</sup>PROM programmer (or for testing purposes) there is a software command sequence for deactivating the data protection. The six step algorithm (Figure 10) will reset the internal protection circuitry, and the device will return to standard operating mode (Figure 12 provides reset timing). After the sixth byte of this reset sequence has been issued, standard byte or page writing can commence.

Figure 11. Software Data Protection Timing

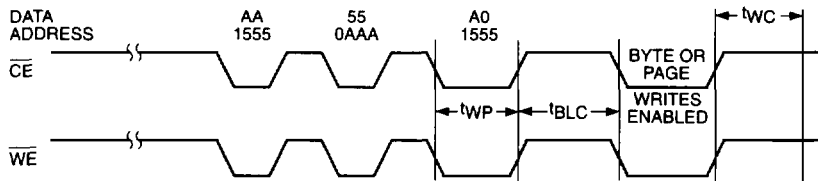

5094 FHD F13

Figure 12. Resetting Software Data Protection Timing

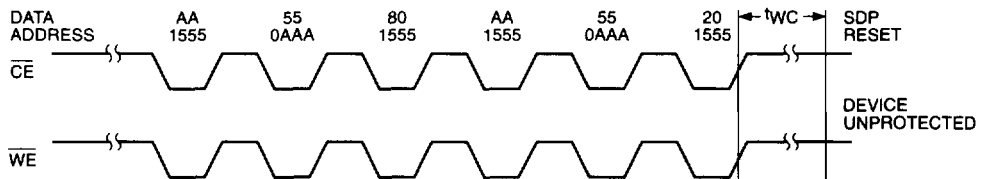

5094 FHD F14

ORDERING INFORMATION

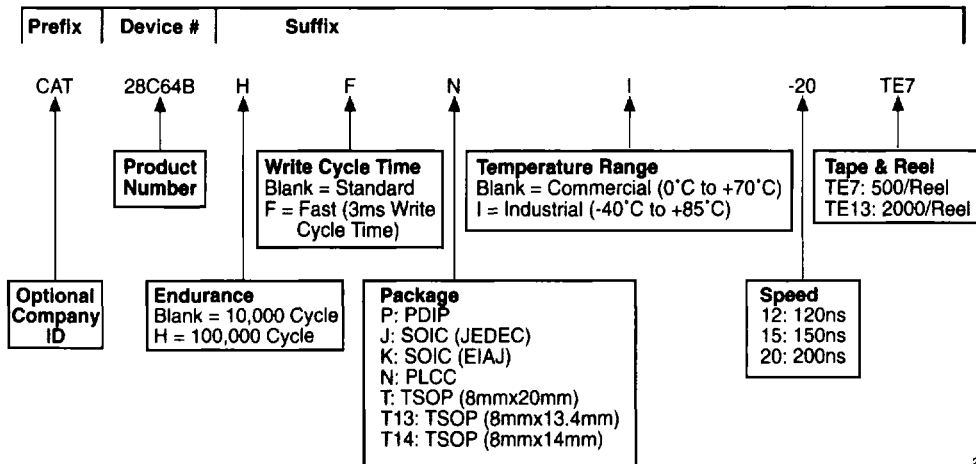

28C64B F15

Notes:

- (1) The device used in the above example is a CAT28C64BHFNI-20TE7 (100,000 Cycle Endurance, 3ms Write Cycle Time, PLCC, Industrial temperature, 200 ns Access Time, Tape & Reel).