



Elite CS-18

High Power DC-12GHz Multi - Throw Switch

SP3T to SP6T versions only

Normally Open

The CS-18 Switch is a broadband multi-position coaxial switch designed to switch RF signals from one input port to any one of 3 through 6 output ports. It is readily adapted to any 50 Ohms transmission line system. The standard actuator gives individual solenoid control of each position and when de-energized, all positions are open. Standard actuator voltage is 28 VDC. The primary advantage of this switch over the miniature versions shown on previous pages is the higher power handling capability.

SP7T and SP8T version available. See additional datasheets

Specifications

RF Contacts:	Break before make			
Actuator	Voltage (VDC) 20°C	12	15	28
	Current (mA)	600	480	270
Switching Time:	20 msec max			
Connectors:	SMA (f), TNC(f)(max frequency 11GHz only)*, N Type (f)			
Weight:	9 oz. max (3 Position) 11 oz (6 Position)			
Temperature Range:	-55°C to +85°C (Operating)			
Shock:	MIL-STD-202 Method 213, Condition D (500G Non Operating)			
Vibration:	MIL-STD-202 Method 214, Condition D (10G RMS Non Operating)			
Humidity:	Moisture Seal Available			
Typical Contact Life:	5 Million Cycles			

RF Power Handling

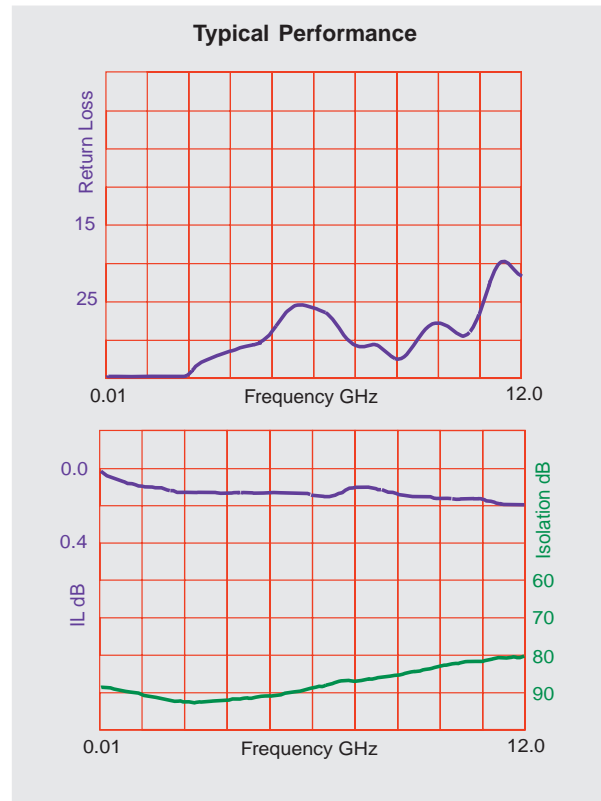
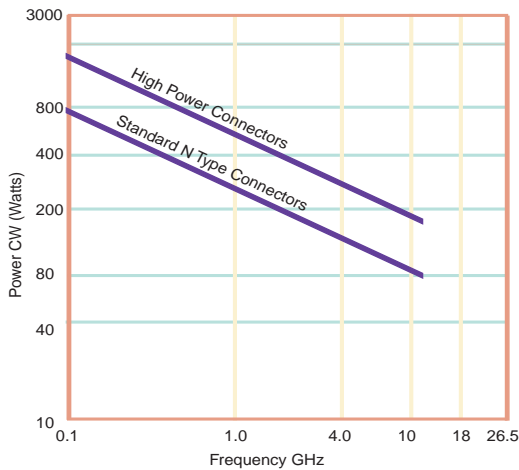

Specifications

	DC-1 GHz	1-4 GHz	4-12 GHz (TNC 11GHz only)
VSWR (max)	1.25:1	1.40:1	1.70:1
Insertion Loss (min)	0.30 dB	0.40 dB	0.50 dB
Isolation (max)	70.0 dB	60.0 dB	60.0 dB



Specifications subject to change without notice.

www.teledynecoax.com
email: coax@teledyne.com

Tel: (800) 351-7368
10/2007

Elite CS-18

High Power DC-12GHz Multi - Throw Switch

SP3T to SP6T versions only

Normally Open

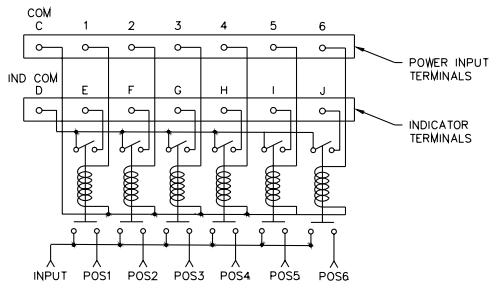

Indicators

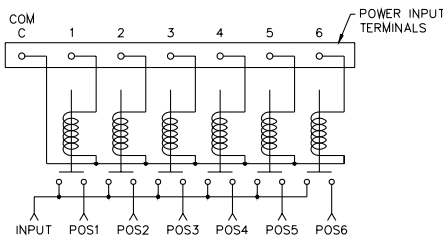

Analog

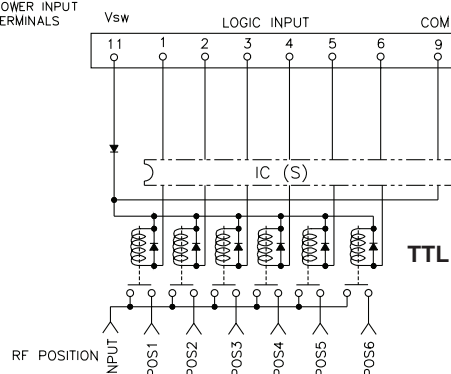

TTL

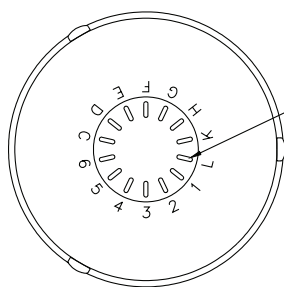

14X SOLDER TERMINALS
SOLDER WIRE USING SN63,
MAXIMUM TEMP 210°C FOR
NO MORE THAN 5 SEC.

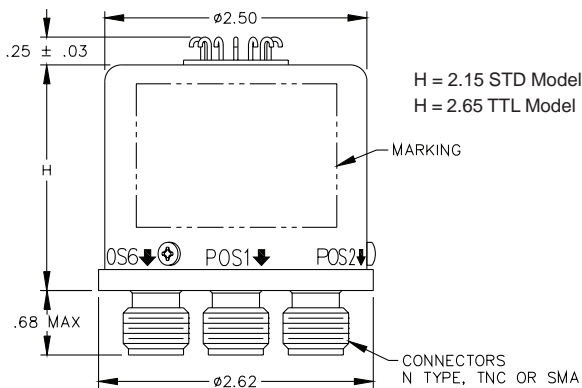

H = 2.15 STD Model
H = 2.65 TTL Model

CONNECTORS
N TYPE, TNC OR SMA

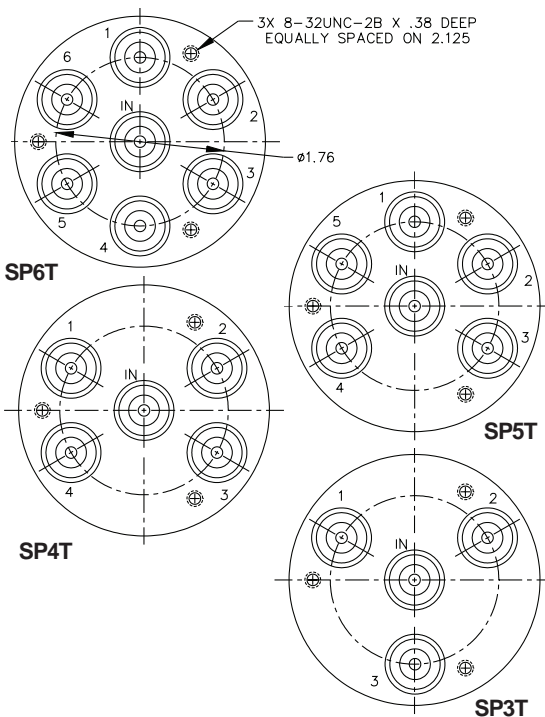

Part Numbering System for CS-18 (Normally Open)

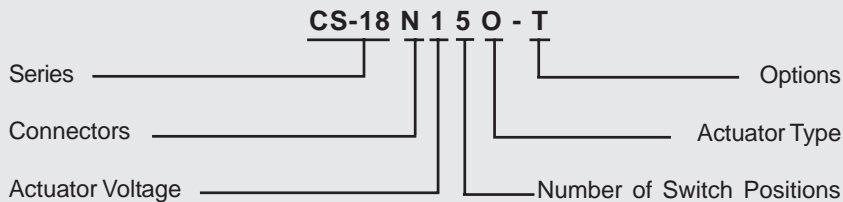

Connector	Actuator Voltage	Number of Positions	Actuator Type	Options
S: SMA Female	1: 28Vdc Normally Open	3: SP3T	O: No Indicator Contacts	T: TTL Drivers with Diodes
N: N type Female	2: 15Vdc Normally Open	4: SP4T	C: Indicator Contacts	R: Positive + Common
T: TNC Female*	3: 12Vdc Normally Open	5: SP5T		TD: TTL Driver with Decoder

For other options contact Factory

6: SP6T

See additional Datasheet for SP7T and SP8T versions



Specifications subject to change without notice.

www.teledynecoax.com
email: coax@teledyne.com

Tel: (800) 351-7368
10/2007