

**MAS9161****80 mA LDO Voltage Regulator IC**

- **Only 10.5  $\mu$ A Ground Pin Current at 1 mA Load Current**
- **Good Transient Performance**
- **Low Dropout Voltage: 200 mV**
- **Low Noise**
- **Enable/Disable Control**
- **Stable with Low-ESR Output Capacitors**

**DESCRIPTION**

MAS9161 LDO voltage regulator is optimized for operation at low ground pin current of just 10.5  $\mu$ A. This combined with the good overall performance makes MAS9161 very suitable for providing continuous supply in low power circuits. The performance of MAS9161 benefits applications where standby periods are long and where long battery life is essential.

In addition to the low ground pin current, MAS9161 excels in dropout voltage (200 mV typical at 80 mA). Even though MAS9161 does not use an external bypass capacitor, the noise level (100 Hz... 100 kHz) is only 70  $\mu$ Vrms with 1  $\mu$ F output capacitor.

The Equivalent Series Resistance (ESR) range of output capacitors that can be used with MAS9161

is very wide. This ESR range from zero up to a couple of Ohms combined with no minimum output current requirement makes the usage of MAS9161 easier and low in cost.

Enable/disable pin allows MAS9161 to be turned off and on. In order to save power the device enters the sleep mode when the regulator is disabled. MAS9161A also includes an auto-discharge function, wherein a shutdown transistor turns on and discharges the output capacitor. MAS9161B does not feature an auto-discharge function.

An internal thermal protection circuit prevents the device from overheating. Also the maximum output current is internally limited.

**FEATURES**

- Extremely Low Current Consumption
- Good Transient Performance
- Output Accuracy  $< \pm 3.3\%$
- Internal Thermal Shutdown
- Short Circuit Protection
- Thin SOT (TSOT-5) or WL-CSP Package
- Several Output Voltage Options Available, see Ordering Information p. 15

**APPLICATIONS**

- Continuously Working Low Power Circuits
- Bluetooth Modules
- Digital Circuits
- Real-Time Clocks (RTC)
- SRAMs
- CMOS Backup Power
- Cellular Phones
- Portable Systems
- Smoke Detectors

## PIN CONFIGURATION

### TSOT-5

Top view

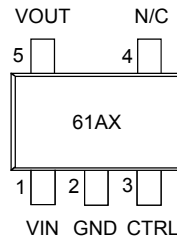

For top marking information see  
ordering information p. 15

### WL-CSP

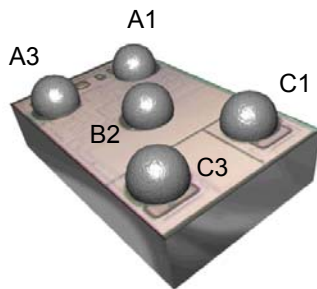

BOTTOM VIEW

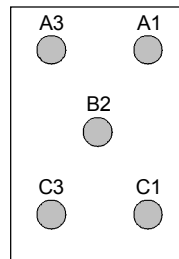

TOP VIEW

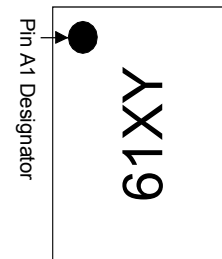

For top marking information see  
ordering information p. 15

## PIN DESCRIPTION

Pin Name	Pin Number in TSOT-5	Pin Number in WL-CSP		Type	Function
		Pin Order 11 Note 1	Pin Order 12 Note 2		
VIN	1	C3	C3	P	Power Supply Voltage
GND	2	B2	A1	G	Ground
CTRL	3	A1	A3	I	Enable/Disable Pin for Regulator
N/C	4	A3	B2	-	Not Connected
VOUT	5	C1	C1	O	Output

G = Ground, I = Input, O = Output, P = Power

**Note 1:** WL-CSP Pin Order 11 is pin compatible with LP3985.

**Note 2:** WL-CSP Pin Order 12 is pin compatible with LP2985.

## BLOCK DIAGRAM

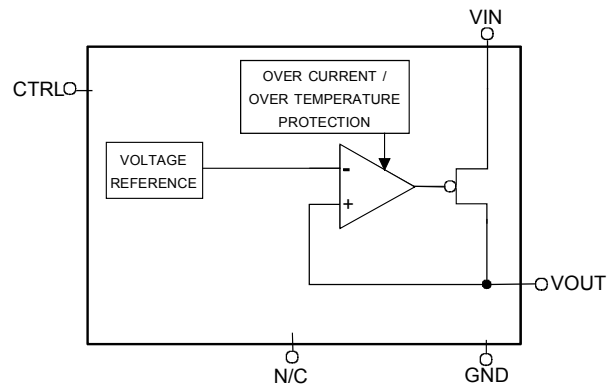

## ABSOLUTE MAXIMUM RATINGS

All voltages with respect to ground.

Parameter	Symbol	Conditions	Min	Max	Unit
Supply Voltage	$V_{IN}$		-0.3	6	V
Voltage Range for All Pins			-0.3	$V_{IN} + 0.3$	V
ESD Rating		HBM		2	kV
Junction Temperature	$T_{Jmax}$			+175 (limited)	°C
Storage Temperature	$T_S$		-55	+150	°C

Stresses beyond those listed may cause permanent damage to the device. The device may not operate under these conditions, but it will not be destroyed.

## RECOMMENDED OPERATING CONDITIONS

All voltages with respect to ground.

Parameter	Symbol	Conditions	Min	Max	Unit
Operating Junction Temperature	$T_J$		-40	+125	°C
Operating Ambient Temperature	$T_A$		-40	+85	°C
Operating Supply Voltage	$V_{IN}$		$V_{OUT(NOM)} + 0.3$ V	5.3	V
		For 1.5 V & 1.8 V Output Options	2.5		

## ELECTRICAL CHARACTERISTICS

### ◆ Thermal Protection

$T_A = -40^{\circ}\text{C}$  to  $+85^{\circ}\text{C}$ , typical values at  $T_A = +27^{\circ}\text{C}$ ,  $V_{IN} = V_{OUT(NOM)} + 1\text{ V}$ ,  $I_{OUT} = 1\text{ mA}$ ,  $C_{IN} = 1.0\text{ }\mu\text{F}$ ,  $C_L = 1.0\text{ }\mu\text{F}$ ,  $V_{CTRL} = 2\text{ V}$ , unless otherwise specified.

Parameter	Symbol	Conditions	Min	Typ	Max	Unit
Threshold	T		130	150	175	$^{\circ}\text{C}$

### ◆ Control Terminal Specifications

$T_A = -40^{\circ}\text{C}$  to  $+85^{\circ}\text{C}$ , typical values at  $T_A = +27^{\circ}\text{C}$ ,  $V_{IN} = V_{OUT(NOM)} + 1\text{ V}$ ,  $I_{OUT} = 1\text{ mA}$ ,  $C_{IN} = 1.0\text{ }\mu\text{F}$ ,  $C_L = 1.0\text{ }\mu\text{F}$ ,  $V_{CTRL} = 2\text{ V}$ , unless otherwise specified.

Parameter	Symbol	Conditions	Min	Typ	Max	Unit
Control Voltage OFF State ON State	$V_{CTRL}$		-0.3 1.2		0.5 $V_{IN} + 0.3$	V
Control Current	$I_{CTRL}$	$V_{CTRL} = 1.2\text{ V}$ $V_{CTRL} = 2.0\text{ V}$ $V_{CTRL} = 3.8\text{ V}$		0.35 0.70 1.50	1.5	$\mu\text{A}$

If CTRL-pin is not connected, MAS9161 is in OFF state (4 M $\Omega$  pull-down resistor to ground).

### ◆ Voltage Parameters

$T_A = -40^{\circ}\text{C}$  to  $+85^{\circ}\text{C}$ , typical values at  $T_A = +27^{\circ}\text{C}$ ,  $V_{IN} = V_{OUT(NOM)} + 1\text{ V}$ ,  $I_{OUT} = 1\text{ mA}$ ,  $C_{IN} = 1.0\text{ }\mu\text{F}$ ,  $C_L = 1.0\text{ }\mu\text{F}$ ,  $V_{CTRL} = 2\text{ V}$ , unless otherwise specified.

Parameter	Symbol	Conditions	Min	Typ	Max	Unit
Output Voltage Tolerance	$V_{OUT}$	$I_{OUT} = 0\text{ mA}$ $I_{OUT} = 50\text{ mA}$	$V_{OUT(NOM)} - 0.06$ $V_{OUT(NOM)} - 0.08$		$V_{OUT(NOM)} + 0.06$ $V_{OUT(NOM)} + 0.06$	V
Dropout Voltage	$V_{DROP}$	$I_{OUT} = 1\text{ mA}$ $I_{OUT} = 10\text{ mA}$ $I_{OUT} = 50\text{ mA}$ $I_{OUT} = 80\text{ mA}$		5 50 150 200		mV

### ◆ Current Parameters

$T_A = -40^{\circ}\text{C}$  to  $+85^{\circ}\text{C}$ , typical values at  $T_A = +27^{\circ}\text{C}$ ,  $V_{IN} = V_{OUT(NOM)} + 1\text{ V}$ ,  $I_{OUT} = 1\text{ mA}$ ,  $C_{IN} = 1.0\text{ }\mu\text{F}$ ,  $C_L = 1.0\text{ }\mu\text{F}$ ,  $V_{CTRL} = 2\text{ V}$ , unless otherwise specified.

Parameter	Symbol	Conditions	Min	Typ	Max	Unit
Continuous Output Current	$I_{OUT}$		0		80	mA
Short Circuit Current	$I_{MAX}$	$R_L = 0\text{ }\Omega$			300	mA
Peak Output Current	$I_{PK}$	$V_{OUT} > 95\% * V_{OUT(NOM)}$		120		mA
Ground Pin Current	$I_{GND}$	$V_{CTRL} = 2.0\text{ V}$ $I_{OUT} = 0\text{ mA}$ $I_{OUT} = 1\text{ mA}$ $I_{OUT} = 10\text{ mA}$ $I_{OUT} = 80\text{ mA}$		10 10.5 16 61		$\mu\text{A}$
Ground Pin Current, Sleep Mode	$I_{GND}$	MAS9161A, $V_{CTRL} = 0\text{ V}$ , $V_{OUT} = 0\text{ V}$	$T_A = +27^{\circ}\text{C}$	0.01	0.5	$\mu\text{A}$
			$T_A = +85^{\circ}\text{C}$	0.2	4	
		MAS9161B, $V_{CTRL} = 0\text{ V}$	$T_A = +27^{\circ}\text{C}$ , $V_{OUT} = 0\text{ V}$	0.3		
			$T_A = +27^{\circ}\text{C}$ $V_{OUT} = 2.7\text{ V}$	4.3		
			$T_A = +85^{\circ}\text{C}$ , $V_{OUT} = 0\text{ V}$	0.4		
		$T_A = +85^{\circ}\text{C}$ $V_{OUT} = 2.7\text{ V}$	4.4			

#### ◆ Power Dissipation

$T_A = -40^\circ\text{C}$  to  $+85^\circ\text{C}$ , typical values at  $T_A = +27^\circ\text{C}$ ,  $V_{IN} = V_{OUT(NOM)} + 1\text{ V}$ ,  $I_{OUT} = 1\text{ mA}$ ,  $C_{IN} = 1.0\ \mu\text{F}$ ,  $C_L = 1.0\ \mu\text{F}$ ,  $V_{CTRL} = 2\text{ V}$ , unless otherwise specified.

Parameter	Symbol	Conditions	Min	Typ	Max	Unit
Thermal Resistance (Junction-to-Air)	$R_{JA}$	thermal test board according to JESD51-7 (4 layers), TSOT-5 package		207		$^\circ\text{C/W}$
		mounted on MAS9161 CSP evaluation board, WL-CSP package		210		
Maximum Power Dissipation	$P_d$	any ambient temperature	$P_{dMAX} = \frac{T_{J(MAX)} - T_A}{R_{JA}}$ Note 1			W

Note 1:  $T_{J(MAX)}$  denotes maximum operating junction temperature ( $+125^\circ\text{C}$ ),  $T_A$  ambient temperature, and  $R_{JA}$  junction-to-air thermal resistance specified above.

#### ◆ Line and Load Regulation

$T_A = -40^\circ\text{C}$  to  $+85^\circ\text{C}$ , typical values at  $T_A = +27^\circ\text{C}$ ,  $V_{IN} = V_{OUT(NOM)} + 1\text{ V}$ ,  $I_{OUT} = 1\text{ mA}$ ,  $C_{IN} = 1.0\ \mu\text{F}$ ,  $C_L = 1.0\ \mu\text{F}$ ,  $V_{CTRL} = 2\text{ V}$ , unless otherwise specified.

Parameter	Symbol	Conditions	Min	Typ	Max	Unit
Line Regulation		$V_{OUT(NOM)} + 1\text{ V} < V_{IN} < 5.3\text{ V}$ , $I_{OUT} = 10\text{ mA}$		1.0	3	mV
Load Regulation		$I_{OUT} = 1\text{ mA}$ to $80\text{ mA}$		12	24	mV

#### ◆ Noise and Ripple Rejection

$T_A = -40^\circ\text{C}$  to  $+85^\circ\text{C}$ , typical values at  $T_A = +27^\circ\text{C}$ ,  $V_{IN} = V_{OUT(NOM)} + 1\text{ V}$ ,  $I_{OUT} = 1\text{ mA}$ ,  $C_{IN} = 1.0\ \mu\text{F}$ ,  $C_L = 1.0\ \mu\text{F}$ ,  $V_{CTRL} = 2\text{ V}$ , unless otherwise specified.

Parameter	Symbol	Conditions	Min	Typ	Max	Unit
Output Noise Voltage	$V_{RMS}$	$100\text{ Hz} < f < 100\text{ kHz}$ , $I_{OUT} = 10\text{ mA}$		70		$\mu\text{Vrms}$
Noise Density	$V_N$	$I_{OUT} = 10\text{ mA}$ , $f = 10\text{ kHz}$		300		$\frac{nV}{\sqrt{\text{Hz}}}$
PSRR		$I_{OUT} = 1\text{ mA}$ $f = 1\text{ kHz}$ $f = 10\text{ kHz}$ $f = 100\text{ kHz}$		50 30 30		dB
		$I_{OUT} = 10\text{ mA}$ $f = 1\text{ kHz}$ $f = 10\text{ kHz}$ $f = 100\text{ kHz}$		50 30 30		dB

◆ **Dynamic Parameters**

$T_A = -40^{\circ}\text{C}$  to  $+85^{\circ}\text{C}$ , typical values at  $T_A = +27^{\circ}\text{C}$ ,  $V_{IN} = V_{OUT(NOM)} + 1\text{ V}$ ,  $I_{OUT} = 1\text{ mA}$ ,  $C_{IN} = 1.0\ \mu\text{F}$ ,  $C_L = 1.0\ \mu\text{F}$ ,  $V_{CTRL} = 2\text{ V}$ , unless otherwise specified.

Parameter	Symbol	Conditions	Min	Typ	Max	Unit
Start-up Delay		$V_{CTRL} = 0$ to $2.4\text{ V}$ , $I_{OUT} = 10\text{ mA}$ (see figure 1 below)		0.5		ms
Overshoot		$V_{CTRL} = 0$ to $2.4\text{ V}$		1.0	8.0	%

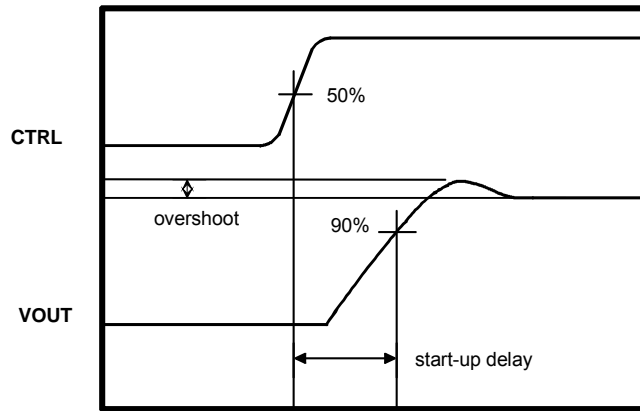

**Figure 1.** Definitions of overshoot and start-up delay.

## TYPICAL PERFORMANCE CHARACTERISTICS

$V_{IN} = 3.8\text{ V}$ ,  $T_A = +27^\circ\text{C}$ ,  $I_{OUT} = 50\text{ mA}$ ,  $C_{IN} = 1.0\ \mu\text{F}$ ,  $C_L = 1.0\ \mu\text{F}$ ,  $V_{CTRL} = 2\text{ V}$ , unless otherwise specified.

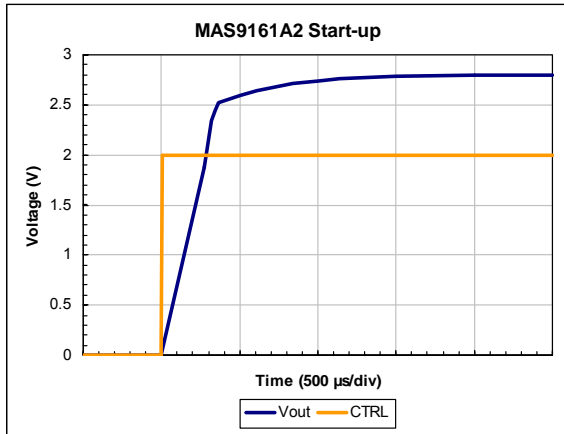

Figure 2. MAS9161A2 typical start-up.

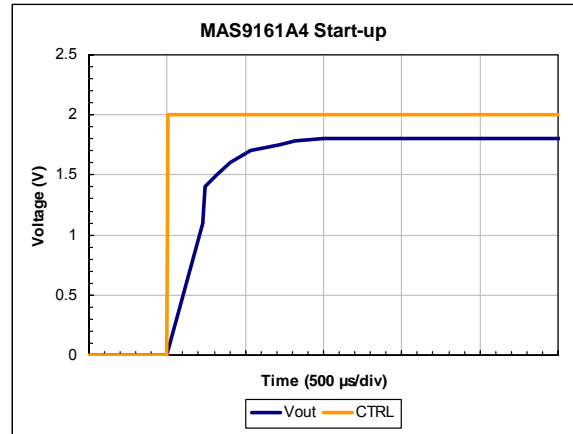

Figure 3. MAS9161A4 typical start-up.  $V_{IN} = 2.8\text{ V}$ .

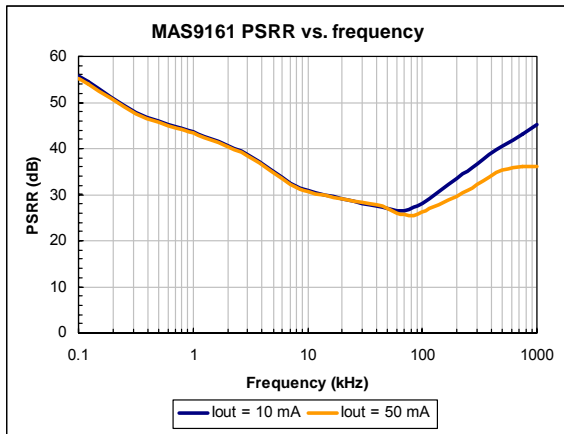

Figure 4. PSRR vs. frequency.  $T_A = +25^\circ\text{C}$ .

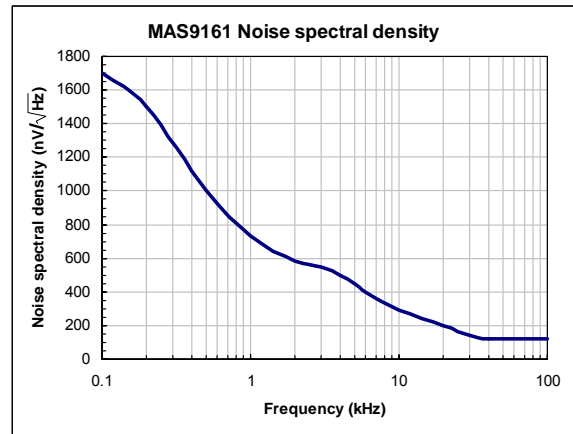

Figure 5. Output noise spectral density.

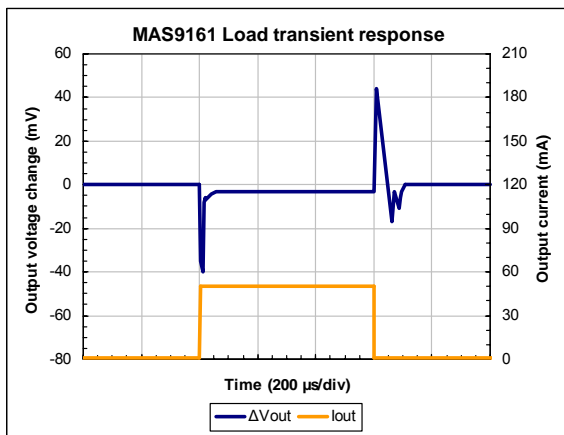

Figure 6. Load transient response.  $I_{OUT} = 1 \dots 50\text{ mA}$  in  $10\ \mu\text{s}$ .

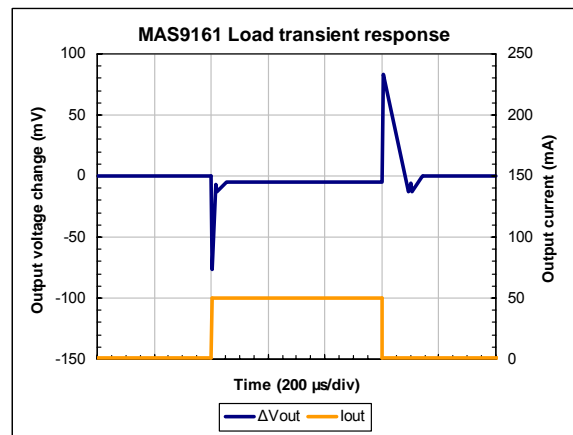

Figure 7. Load transient response.  $I_{OUT} = 1 \dots 50\text{ mA}$  in  $2\ \mu\text{s}$ .

## TYPICAL PERFORMANCE CHARACTERISTICS

$V_{IN} = 3.8\text{ V}$ ,  $T_A = +27^\circ\text{C}$ ,  $I_{OUT} = 50\text{ mA}$ ,  $C_{IN} = 1.0\ \mu\text{F}$ ,  $C_L = 1.0\ \mu\text{F}$ ,  $V_{CTRL} = 2\text{ V}$ , unless otherwise specified.

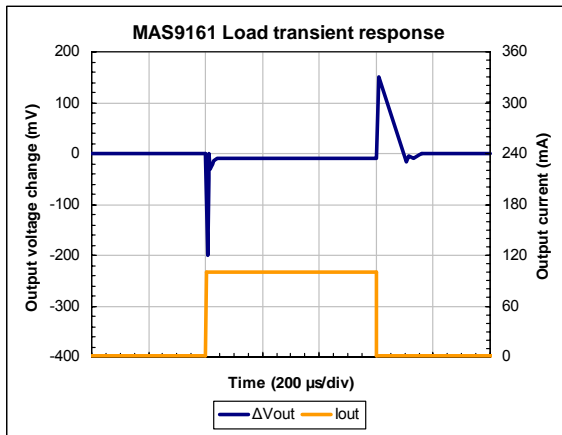

Figure 8. Load transient response.  $I_{OUT} = 1 \dots 100\text{ mA}$  in  $2\ \mu\text{s}$ .

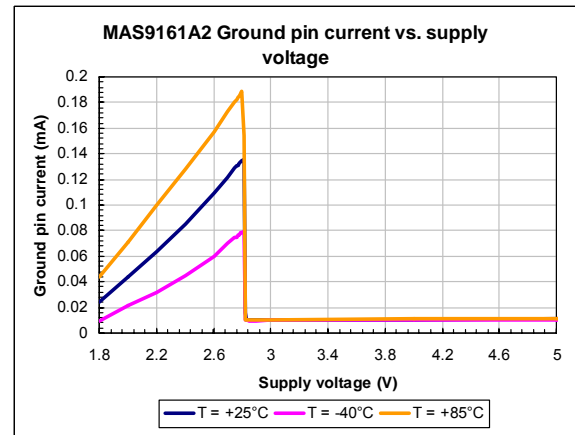

Figure 9. MAS9161A2 ground pin current against the supply voltage.  $I_{OUT} = 0\text{ mA}$ .

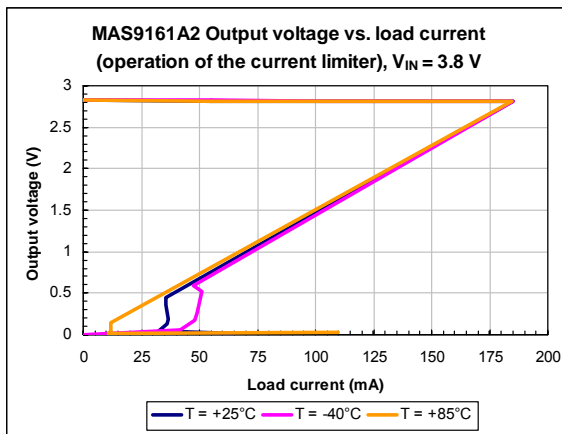

Figure 10. MAS9161A2 output voltage vs. load current (operation of the current limiter).  $V_{IN} = 3.8\text{ V}$ .

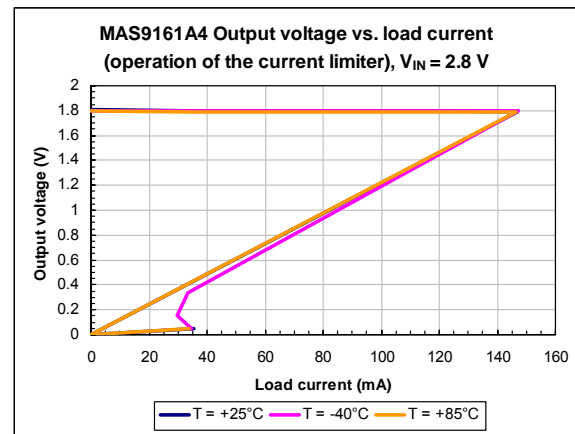

Figure 11. MAS9161A4 output voltage vs. load current (operation of the current limiter).  $V_{IN} = 2.8\text{ V}$ .

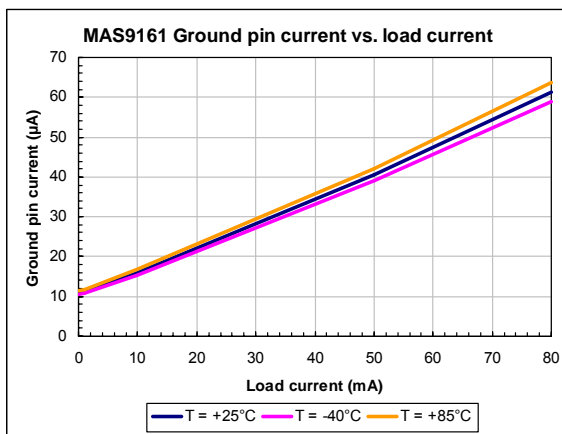

Figure 12. Ground pin current vs. load current.

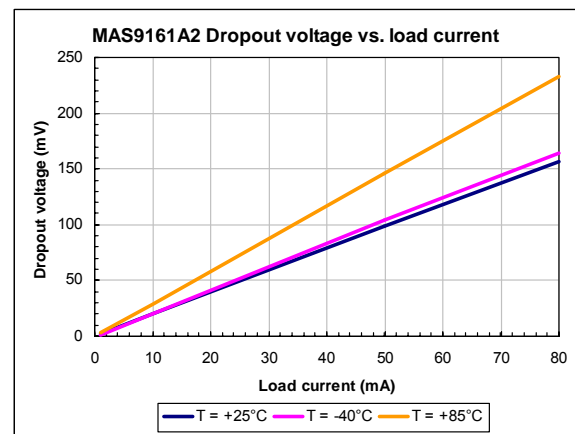

Figure 13. MAS9161A2 dropout voltage vs. load current.



## TYPICAL PERFORMANCE CHARACTERISTICS

$V_{IN} = 3.8\text{ V}$ ,  $T_A = +27^\circ\text{C}$ ,  $I_{OUT} = 50\text{ mA}$ ,  $C_{IN} = 1.0\ \mu\text{F}$ ,  $C_L = 1.0\ \mu\text{F}$ ,  $V_{CTRL} = 2\text{ V}$ , unless otherwise specified.

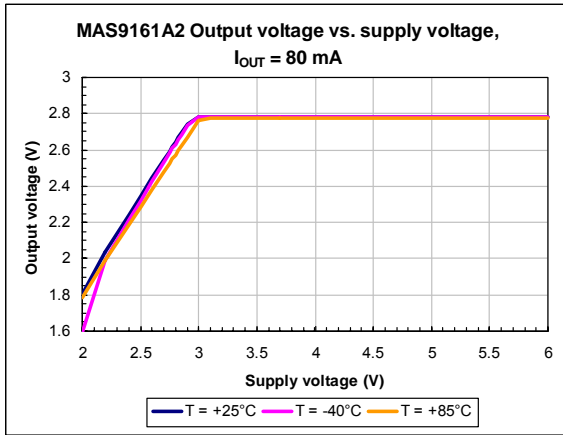

Figure 14. MAS9161A2 output voltage vs. supply voltage.  $I_{OUT} = 80\text{ mA}$

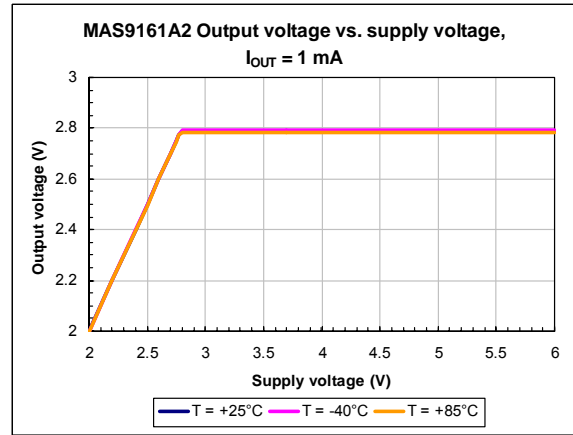

Figure 15. MAS9161A2 output voltage vs. supply voltage.  $I_{OUT} = 1\text{ mA}$ .

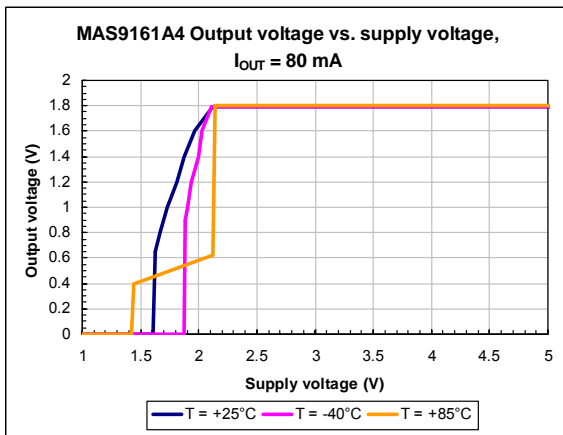

Figure 16. MAS9161A4 output voltage vs. supply voltage.  $I_{OUT} = 80\text{ mA}$ .

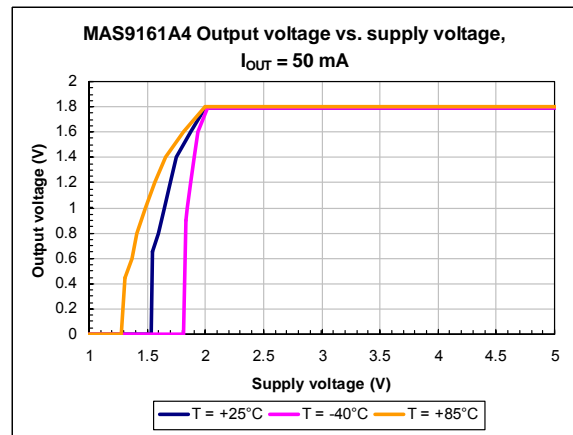

Figure 17. MAS9161A4 output voltage vs. supply voltage.  $I_{OUT} = 50\text{ mA}$ .

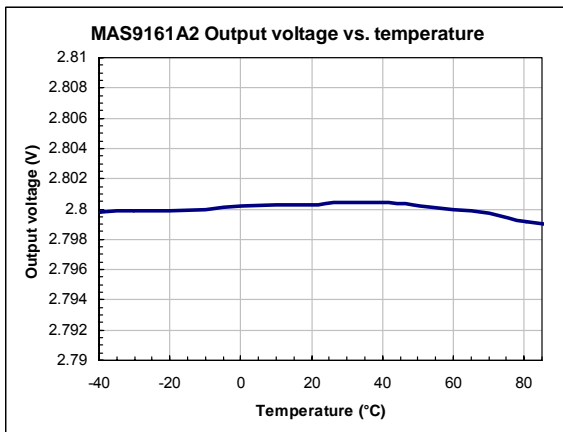

Figure 18. MAS9161A2 output voltage vs. temperature.

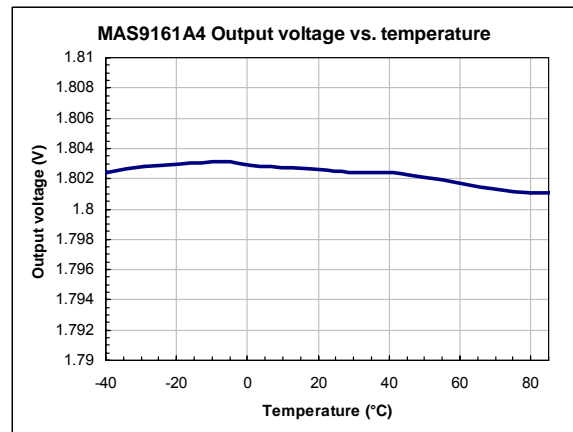
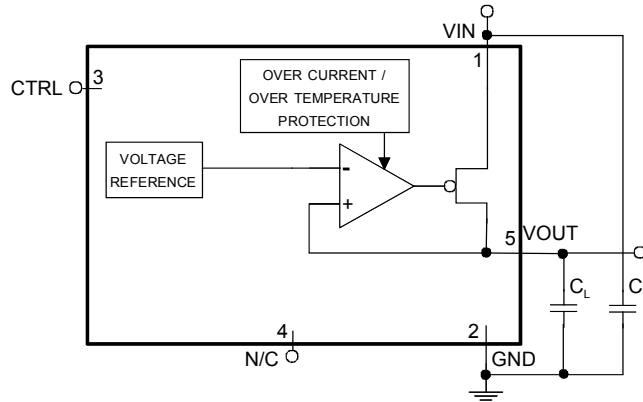

Figure 19. MAS9161A4 output voltage vs. temperature.  $V_{IN} = 2.8\text{ V}$ .

## APPLICATION INFORMATION

MAS9161 is available in two different versions:

- Version A includes an auto-discharge function, wherein a shutdown transistor turns on and discharges the output capacitor, when MAS9161 is turned off. Thus VOUT pin reaches the value 0 V fast after shut-down.
- Version B does not feature the auto-discharge function. The voltage in VOUT pin, when MAS9161 is turned off, depends on the load circuits leakage: if the load has big leakage current, VOUT rapidly drops to the value 0 V, but if the leakage current is non-existing, VOUT pin stays in  $V_{OUT(NOM)}$  value.



Parameter	Symbol	Min	Typ	Max	Unit	Note
Output Capacitance	$C_L$	0.6	1.0		$\mu\text{F}$ $\Omega$	1. The selected capacitor has to meet the minimum capacitance requirement in all operating conditions. 2. Ceramic and film capacitors can be used.
Effective Series Resistance	ESR	0		3		1. When within this range stable with all $I_{OUT} = 0 \text{ mA} \dots 80 \text{ mA}$ values.
Input Capacitance	$C_{IN}$	0.23			$\mu\text{F}$	1. A big enough input capacitance is needed to prevent possible impedance interactions between the supply and MAS9161. 2. Ceramic, tantalum, and film capacitors can be used. If using a tantalum capacitor, it should be checked that surge current rating is sufficient for the application. In the case that the inductance between a battery and MAS9161 is very small ( $< 0.1 \mu\text{H}$ ) $0.22 \mu\text{F}$ input capacitor is sufficient.

Values given on the table are minimum requirements unless otherwise specified. When selecting capacitors, tolerance and temperature coefficient must be considered to **make sure that the requirement is met in all potential operating conditions.**

**PACKAGE (TSOT-5) OUTLINE**

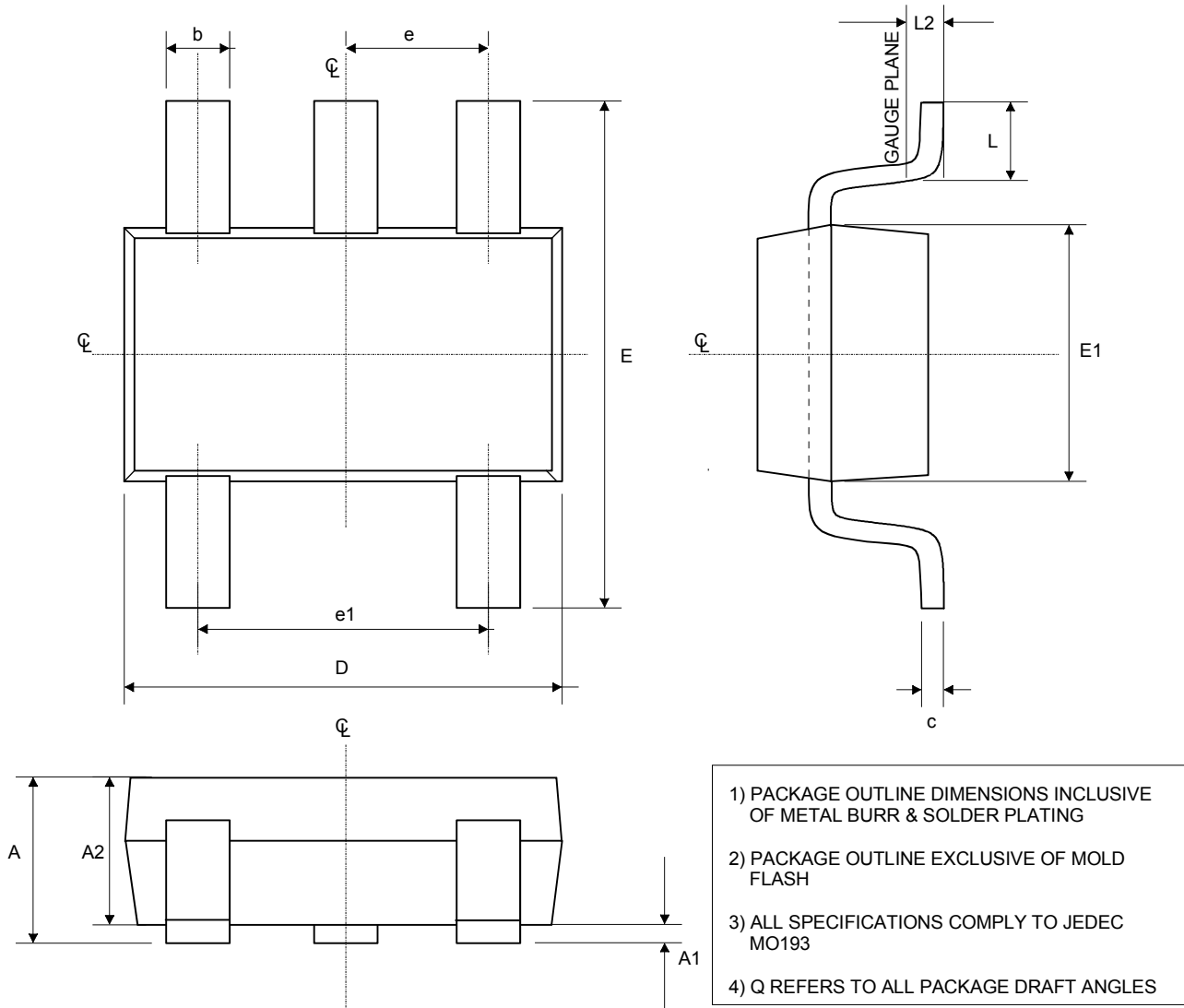

Symbol	Min	Nom	Max	Unit
A	--	--	1.00	mm
A1	0.01	0.05	0.10	mm
A2	0.84	0.87	0.90	mm
b	0.30	--	0.45	mm
c	0.12	0.127	0.20	mm
D		2.90BSC		mm
E		2.80BSC		mm
E1		1.60BSC		mm
e		0.95BSC		mm
e1		1.90BSC		mm
L	0.30	0.40	0.50	mm
L2		0.25BSC		mm
Q	4°	10°	12°	

## PACKAGE (WL-CSP) OUTLINE

All dimensions in microns, drawings not to scale.

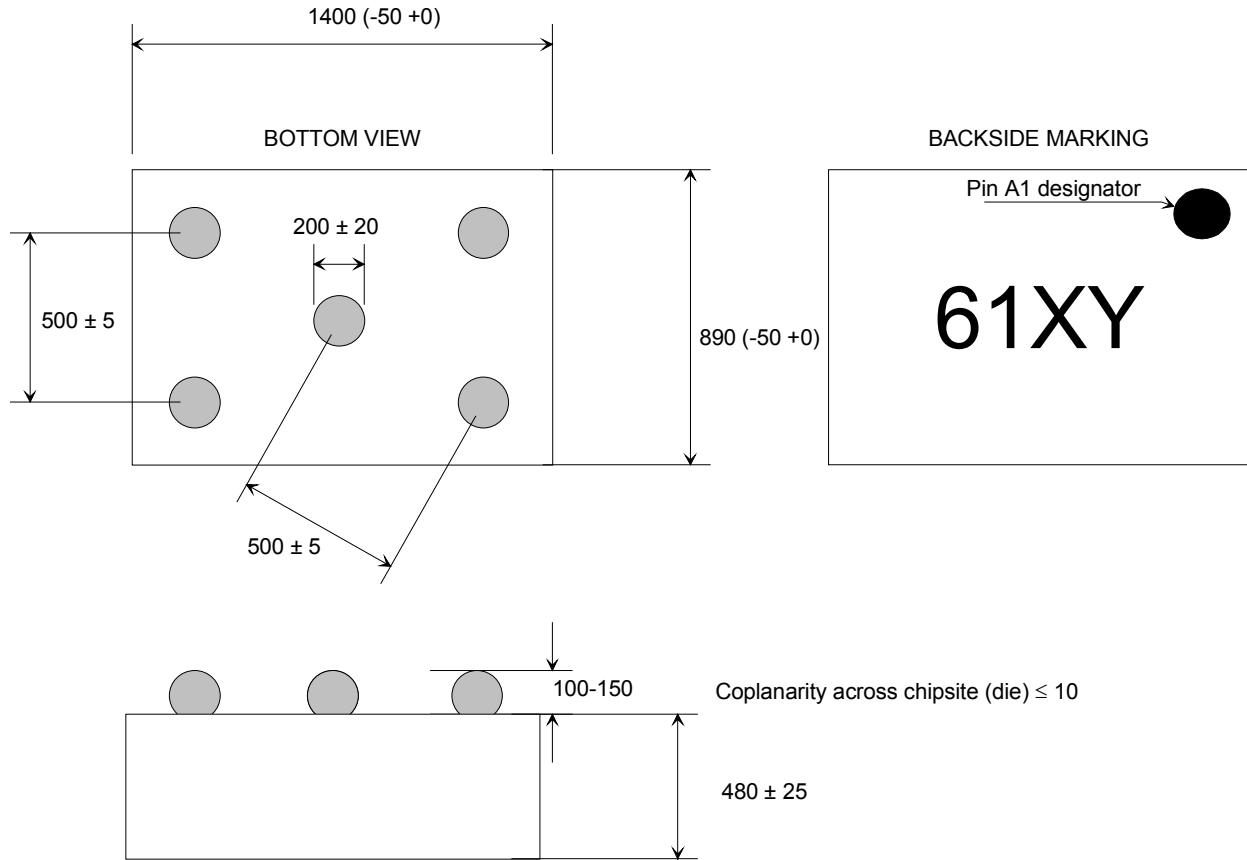

Definitions (see ordering information p. 15):

X = Package option  
Y = Output voltage option

---

## SOLDERING INFORMATION

---

◆ For Eutectic Sn/Pb TSOT-5 and WL-CSP

Resistance to Soldering Heat	According to RSH test IEC 68-2-58/20 2*220°C
Maximum Temperature	240°C
Maximum Number of Reflow Cycles	3
Reflow profile	Thermal profile parameters stated in JESD22-A113 should not be exceeded. <a href="http://www.jedec.org">http://www.jedec.org</a>
Seating Plane Co-planarity	max 0.08 mm
Lead Finish	Solder plate 7.62 - 25.4 µm, material Sn 85% Pb 15%
WL-CSP Balls	Material Sn 63% Pb 37% (eutectic)

◆ For Lead-Free TSOT-5

Resistance to Soldering Heat	According to RSH test IEC 68-2-58/20
Maximum Temperature	260°C
Maximum Number of Reflow Cycles	3
Reflow profile	Thermal profile parameters stated in JESD22-A113 should not be exceeded. <a href="http://www.jedec.org">http://www.jedec.org</a>
Seating Plane Co-planarity	max 0.08 mm
Lead Finish	Solder plate 7.62 - 25.4 µm, material Matte Tin

## TAPE & REEL SPECIFICATIONS (TSOT-5)

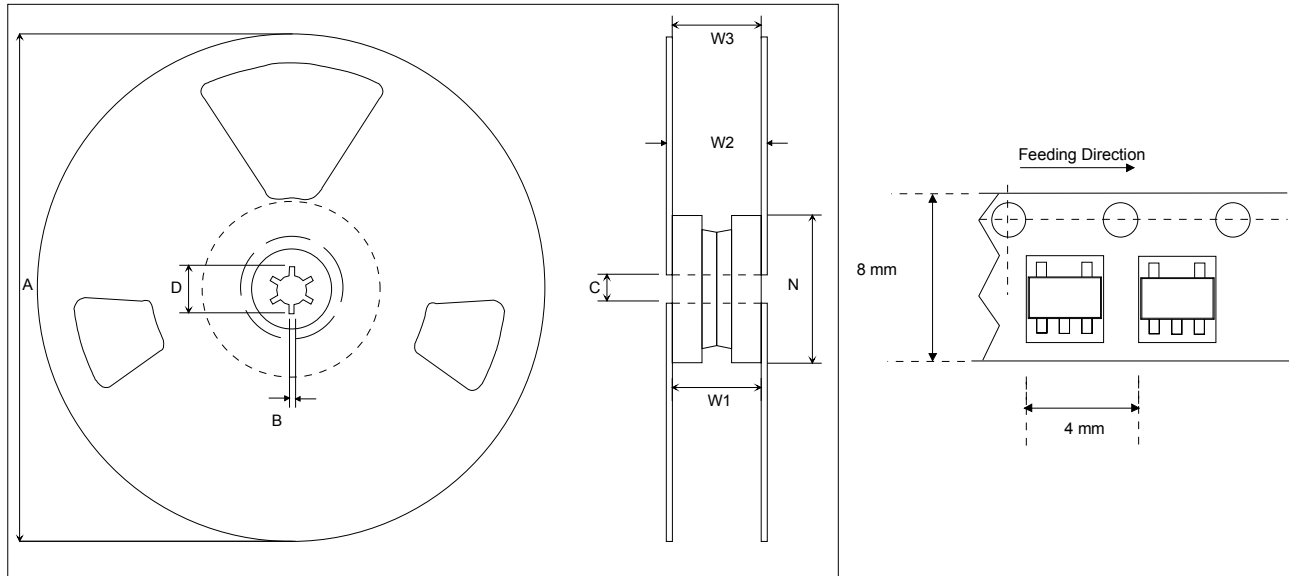

Other Dimensions according to EIA-481 Standard

3000 Components on Each Reel

Dimension	Min	Max	Unit
A		178	mm
B	1.5		mm
C	12.80	13.50	mm
D	20.2		mm
N	50		mm
W <sub>1</sub> (measured at hub)	8.4	9.9	mm
W <sub>2</sub> (measured at hub)		14.4	mm
W <sub>3</sub> (includes flange distortion at outer edge)	7.9	10.9	mm
Trailer	160		mm
Leader	390, of which minimum 160 mm of empty carrier tape sealed with cover tape		mm

## ORDERING INFORMATION

- Version A: MAS9161 with auto-discharge function
- Version B: MAS9161 without auto-discharge function  
(see p. 10 for definition of auto-discharge function)
  
- For Pin Order definition see the pin description on page 2.

Product Code	Output Voltage	Version	Top Marking	Pin Order	Package	Comments
MAS9161B5GA06	1.5 V	B	61B5		TSOT-5	Tape and Reel
MAS9161B5GB06	1.5 V	B	61B5 (B in the bottom marking to indicate lead-free)		TSOT-5 lead-free	Tape and Reel
MAS9161B5CA11	1.5 V	B	61B5	11	WL-CSP	Tape and Reel
MAS9161B5CA12	1.5 V	B	61Y5	12	WL-CSP	Tape and Reel
MAS9161AGA4-T	1.8 V	A	61A4		TSOT-5	Tape and Reel
MAS9161B4GA06	1.8 V	B	61B4		TSOT-5	Tape and Reel
MAS9161AGB4-T	1.8 V	A	61A4 (B in the bottom marking to indicate lead-free)		TSOT-5 lead-free	Tape and Reel
MAS9161B4GB06	1.8 V	B	61B4 (B in the bottom marking to indicate lead-free)		TSOT-5 lead-free	Tape and Reel
MAS9161A4CA11	1.8 V	A	61A4	11	WL-CSP	Tape and Reel
MAS9161B4CA11	1.8 V	B	61B4	11	WL-CSP	Tape and Reel
MAS9161A4CA12	1.8 V	A	61Z4	12	WL-CSP	Tape and Reel
MAS9161B4CA12	1.8 V	B	61Y4	12	WL-CSP	Tape and Reel
MAS9161AGA3-T	2.5 V	A	61A3		TSOT-5	Tape and Reel
MAS9161B3GA06	2.5 V	B	61B3		TSOT-5	Tape and Reel
MAS9161AGB3-T	2.5 V	A	61A3 (B in the bottom marking to indicate lead-free)		TSOT-5 lead-free	Tape and Reel
MAS9161B3GB06	2.5 V	B	61B3 (B in the bottom marking to indicate lead-free)		TSOT-5 lead-free	Tape and Reel
MAS9161A3CA11	2.5 V	A	61A3	11	WL-CSP	Tape and Reel
MAS9161B3CA11	2.5 V	B	61B3	11	WL-CSP	Tape and Reel
MAS9161A3CA12	2.5 V	A	61Z3	12	WL-CSP	Tape and Reel
MAS9161B3CA12	2.5 V	B	61Y3	12	WL-CSP	Tape and Reel
MAS9161AGAE-T	2.65 V	A	61AE		TSOT-5	Tape and Reel
MAS9161BEGA06	2.65 V	B	61BE		TSOT-5	Tape and Reel
MAS9161AGBE-T	2.65 V	A	61AE (B in the bottom marking to indicate lead-free)		TSOT-5 lead-free	Tape and Reel
MAS9161BEGB06	2.65 V	B	61BE (B in the bottom marking to indicate lead-free)		TSOT-5 lead-free	Tape and Reel
MAS9161AECA11	2.65 V	A	61AE	11	WL-CSP	Tape and Reel
MAS9161BECA11	2.65 V	B	61BE	11	WL-CSP	Tape and Reel
MAS9161AECA12	2.65 V	A	61ZE	12	WL-CSP	Tape and Reel
MAS9161BECA12	2.65 V	B	61YE	12	WL-CSP	Tape and Reel

Product Code	Output Voltage	Version	Top Marking	Pin Order	Package	Comments
MAS9161AGA2-T	2.8 V	A	61A2		TSOT-5	Tape and Reel
MAS9161B2GA06	2.8 V	B	61B2		TSOT-5	Tape and Reel
MAS9161AGB2-T	2.8 V	A	61A2 (B in the bottom marking to indicate lead-free)		TSOT-5 lead-free	Tape and Reel
MAS9161B2GB06	2.8 V	B	61B2 (B in the bottom marking to indicate lead-free)		TSOT-5 lead-free	Tape and Reel
MAS9161A2CA11	2.8 V	A	61A2	11	WL-CSP	Tape and Reel
MAS9161B2CA11	2.8 V	B	61B2	11	WL-CSP	Tape and Reel
MAS9161A2CA12	2.8 V	A	61Z2	12	WL-CSP	Tape and Reel
MAS9161B2CA12	2.8 V	B	61Y2	12	WL-CSP	Tape and Reel
MAS9161AGA7-T	2.9 V	A	61A7		TSOT-5	Tape and Reel
MAS9161B7GA06	2.9 V	B	61B7		TSOT-5	Tape and Reel
MAS9161AGB7-T	2.9 V	A	61A7 (B in the bottom marking to indicate lead-free)		TSOT-5 lead-free	Tape and Reel
MAS9161B7GB06	2.9 V	B	61B7 (B in the bottom marking to indicate lead-free)		TSOT-5 lead-free	Tape and Reel
MAS9161A7CA11	2.9 V	A	61A7	11	WL-CSP	Tape and Reel
MAS9161B7CA11	2.9 V	B	61B7	11	WL-CSP	Tape and Reel
MAS9161A7CA12	2.9 V	A	61Z7	12	WL-CSP	Tape and Reel
MAS9161B7CA12	2.9 V	B	61Y7	12	WL-CSP	Tape and Reel
MAS9161AGA6-T	3.0 V	A	61A6		TSOT-5	Tape and Reel
MAS9161B6GA06	3.0 V	B	61B6		TSOT-5	Tape and Reel
MAS9161AGB6-T	3.0 V	A	61A6 (B in the bottom marking to indicate lead-free)		TSOT-5 lead-free	Tape and Reel
MAS9161B6GB06	3.0 V	B	61B6 (B in the bottom marking to indicate lead-free)		TSOT-5 lead-free	Tape and Reel
MAS9161A6CA11	3.0 V	A	61A6	11	WL-CSP	Tape and Reel
MAS9161B6CA11	3.0 V	B	61B6	11	WL-CSP	Tape and Reel
MAS9161A6CA12	3.0 V	A	61Z6	12	WL-CSP	Tape and Reel
MAS9161B6CA12	3.0 V	B	61Y6	12	WL-CSP	Tape and Reel
MAS9161AGAD-T	3.1 V	A	61AD		TSOT-5	Tape and Reel
MAS9161BDGA06	3.1 V	B	61BD		TSOT-5	Tape and Reel
MAS9161AGBD-T	3.1 V	A	61AD (B in the bottom marking to indicate lead-free)		TSOT-5 lead-free	Tape and Reel
MAS9161BDGB06	3.1 V	B	61BD (B in the bottom marking to indicate lead-free)		TSOT-5 lead-free	Tape and Reel
MAS9161ADCA11	3.1 V	A	61AD	11	WL-CSP	Tape and Reel
MAS9161BDCA11	3.1 V	B	61BD	11	WL-CSP	Tape and Reel
MAS9161ADCA12	3.1 V	A	61ZD	12	WL-CSP	Tape and Reel
MAS9161BDCA12	3.1 V	B	61YD	12	WL-CSP	Tape and Reel



Product Code	Output Voltage	Version	Top Marking	Pin Order	Package	Comments
MAS9161AGA1-T	3.3 V	A	61A1		TSOT-5	Tape and Reel
MAS9161B1GA06	3.3 V	B	61B1		TSOT-5	Tape and Reel
MAS9161AGB1-T	3.3 V	A	61A1 (B in the bottom marking to indicate lead-free)		TSOT-5 lead-free	Tape and Reel
MAS9161B1GB06	3.3 V	B	61B1 (B in the bottom marking to indicate lead-free)		TSOT-5 lead-free	Tape and Reel
MAS9161A1CA11	3.3 V	A	61A1	11	WL-CSP	Tape and Reel
MAS9161B1CA11	3.3 V	B	61B1	11	WL-CSP	Tape and Reel
MAS9161A1CA12	3.3 V	A	61Z1	12	WL-CSP	Tape and Reel
MAS9161B1CA12	3.3 V	B	61Y1	12	WL-CSP	Tape and Reel

For more voltage options contact Micro Analog Systems Oy.

**Offered in North America by**



Evox Rifa, Inc.  
300 Tri-State International, Suite 375  
Lincolnshire, IL 60069 USA  
Tel: 1 847 948 9511  
Fax: 1 847 948 9320  
Email: [service@evoxrifa.com](mailto:service@evoxrifa.com)  
Web: [http://www.evoxrifa.com/n\\_america](http://www.evoxrifa.com/n_america)

**MICRO ANALOG SYSTEMS OY CONTACTS**

Micro Analog Systems Oy Kamreerintie 2, P.O.Box 51 FIN-02771 Espoo, FINLAND <a href="http://www.mas-oy.com">http://www.mas-oy.com</a>	Tel. (09) 80 521 Tel. Int. +358 9 80 521 Telefax +358 9 805 3213 E-mail: <a href="mailto:info@mas-oy.com">info@mas-oy.com</a>
--	--

**NOTICE**

Micro Analog Systems Oy reserves the right to make changes to the products contained in this data sheet in order to improve the design or performance and to supply the best possible products. Micro Analog Systems Oy assumes no responsibility for the use of any circuits shown in this data sheet, conveys no license under any patent or other rights unless otherwise specified in this data sheet, and makes no claim that the circuits are free from patent infringement. Applications for any devices shown in this data sheet are for illustration only and Micro Analog Systems Oy makes no claim or warranty that such applications will be suitable for the use specified without further testing or modification.