

PRELIMINARY

MH8M36DJ/DNJ-5,-6,-7

FAST PAGE MODE 301989888-BIT (8388608 - WORD BY 36-BIT) DYNAMIC RAM MODULE

DESCRIPTION

The MH8M36DJ/DNJ is 8388608 - word by 36 - bit dynamic RAM module . That module consists of sixteen industry 4M x 4 dynamic RAMs and two industry quad cas 4M x 4 dynamic RAMs in SOJ.

The mounting of SOJ on a single in-line package provides any application where high densities and large quantities of memory are required.

FEATURES

Performance ranges

Type name	Access time (max. ns)	Cycle time (max. ns)	Power dissipation (max. mW)
MH8M36DJ/DNJ - 5	50	90	5895
MH8M36DJ/DNJ - 6	60	110	4860
MH8M36DJ/DNJ - 7	70	130	4275

- Single 5V±10% supply operation
- 72pin Single In-Line Package
- Low stand-by power dissipation
 - 55mW(Max) CMOS input level
- Low operation power dissipation
 - MH8M36DJ/DNJ - 5 --- 7.23W(Max)
 - MH8M36DJ/DNJ - 6 --- 5.97W(Max)
 - MH8M36DJ/DNJ - 7 --- 5.25W(Max)
- Includes decoupling capacitors (0.22µF x 18)
- 2048 refresh cycles every 32.0ms (A0-A10)
- **MH8M36DJ is gold plating contact .**
MH8M3DNJ is solder with Nickel under plating contact .

APPLICATION

Main memory unit for computers, Microcomputer memory, Refresh memory for CRT.

FUNCTION

The MH8M36DJ/DNJ provide, in addition to normal read, write a number of other functions, e. g., fast page mode, RAS-only refresh. The input conditions for each are shown in Table1.

PIN CONFIGURATION (TOP VIEW)

[Double side]

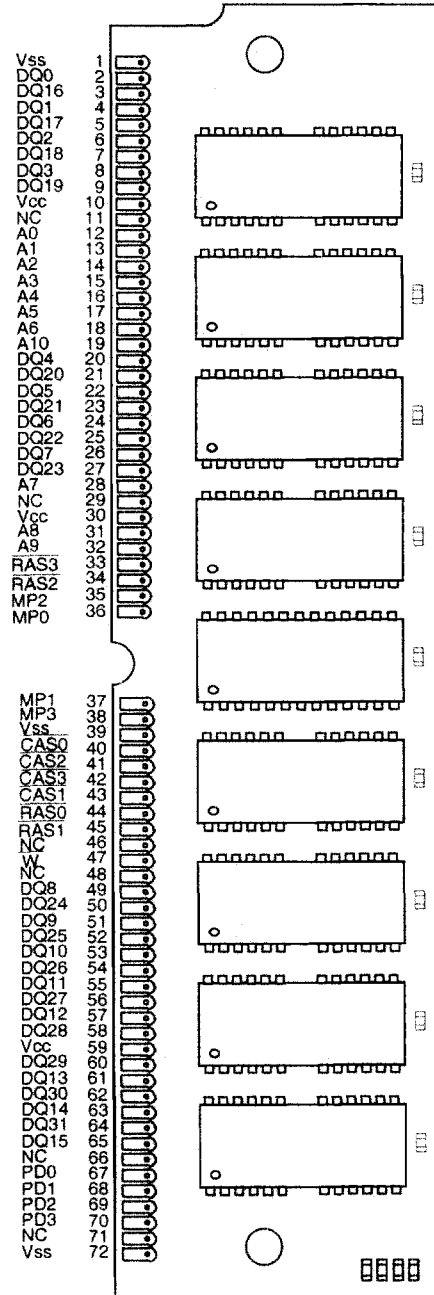

Outline 72N9R-C

	- 5	- 6	- 7
PD0	NC	NC	NC
PD1	Vss	Vss	Vss
PD2	Vss	NC	Vss
PD3	Vss	NC	NC

NC: NO CONNECTION

PRELIMINARY

MH8M36DJ/DNJ-5,-6,-7

FAST PAGE MODE 301989888-BIT (8388608 - WORD BY 36-BIT) DYNAMIC RAM MODULE

Table 1 Input conditions for each mode

Operation	Inputs					Input/Output		Refresh	Remark
	RAS	CAS	W	Row address	Column address	Input	Output		
Read	ACT	ACT	NAC	APD	APD	OPN	VLD	YES	Fast page mode identical
Write (Early write)	ACT	ACT	ACT	APD	APD	VLD	OPN	YES	
RAS-only refresh	ACT	NAC	DNC	APD	DNC	DNC	OPN	YES	
Hidden refresh	ACT	ACT	NAC	APD	DNC	OPN	VLD	YES	
CAS before RAS refresh	ACT	ACT	NAC	DNC	DNC	DNC	OPN	YES	
Standby	NAC	DNC	DNC	DNC	DNC	DNC	OPN	NO	

Note : ACT : active, NAC : nonactive, DNC : don't care, VLD : valid, IVD : Invalid, APD : applied, OPN : open

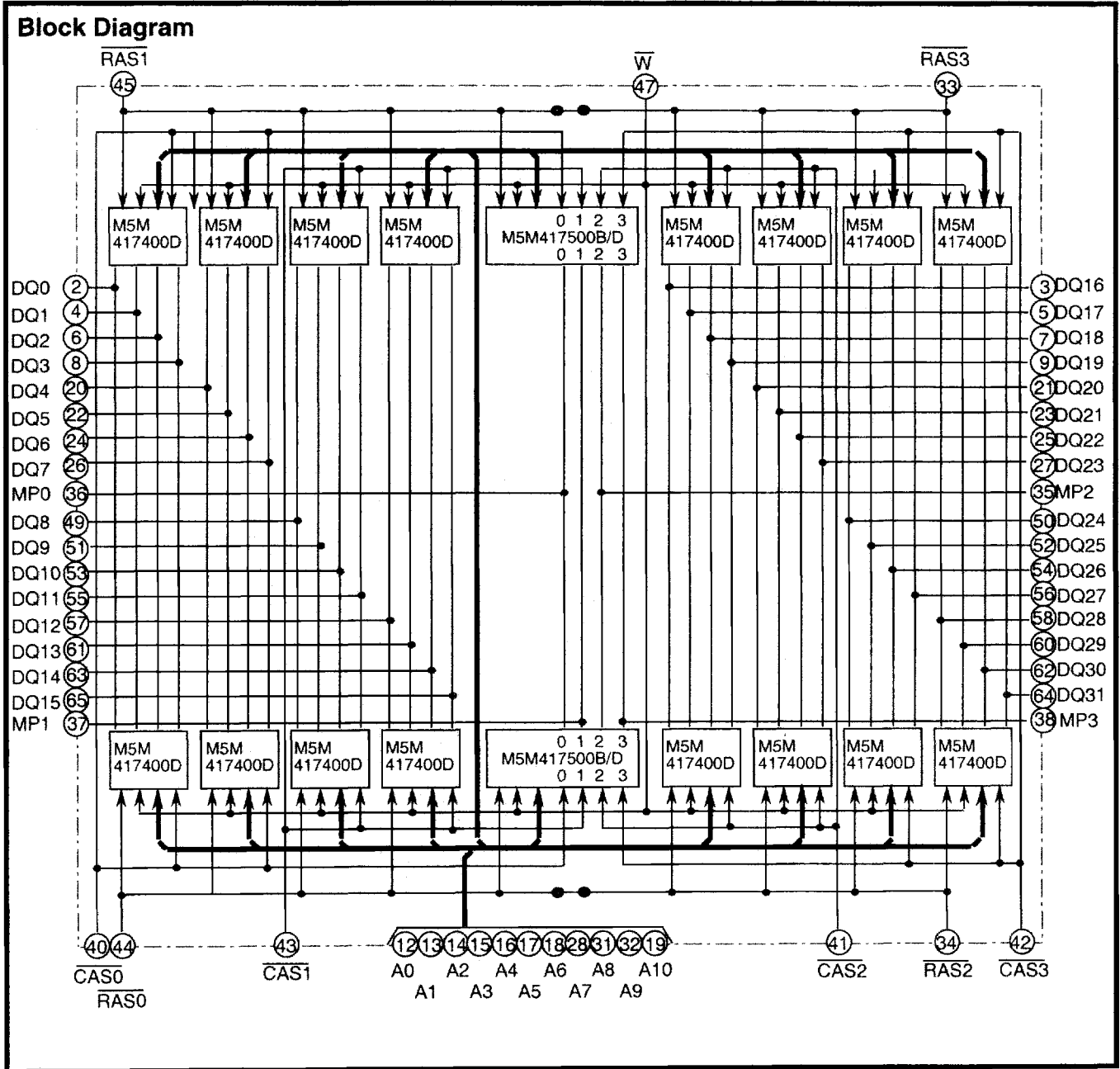

PRELIMINARY

MH8M36DJ/DNJ-5,-6,-7

FAST PAGE MODE 301989888-BIT (8388608 - WORD BY 36-BIT) DYNAMIC RAM MODULE

ABSOLUTE MAXIMUM RATINGS

Symbol	Parameter	Conditions	Ratings	Unit
Vcc	Supply voltage		-1 - 7	V
VI	Input voltage	With respect to Vss	-1 - 7	V
VO	Output voltage		-1 - 7	V
IO	Output current		50	mA
Pd	Power dissipation	Ta=25 °C	18	W
Topr	Operating temperature		0 - 70	°C
Tstg	Storage temperature		-40 - 125	°C

RECOMMENDED OPERATING CONDITIONS

(Ta=0 ~ 70 °C, unless otherwise noted) (Note 1)

Symbol	Parameter	Limits			Unit
		Min	Nom	Max	
Vcc	Supply voltage	4.5	5	5.5	V
Vss	Supply voltage	0	0	0	V
VIH	High-level input voltage, all inputs	2.4		5.5	V
VIL	Low-level input voltage, all inputs	-1.0**		0.8	V

Note 1: All voltage values are with respect to Vss

**VIL(min.) is -2.0V when pulse width is less than 25ns. (Pulse width is with respect to VSS.)

ELECTRICAL CHARACTERISTICS

(Ta=0 ~ 70 °C, Vcc=5V ± 10%, Vss=0V, unless otherwise noted) (Note 2)

Symbol	Parameter	Test conditions	Limits			Unit	
			Min	Typ	Max		
VOH	High-level output voltage	IOH=-5mA	2.4		Vcc	V	
VOL	Low-level output voltage	IOl=4.2mA	0		0.4	V	
IOZ	Off-state output current	Q floating 0V ≤ Vout ≤ 5.5V	-20		20	µA	
II	Input current	0V ≤ VIN ≤ 6.0V, Other inputs pins=0V	-180		180	µA	
Icc1 (AV)	Average supply current from Vcc operating (Note 3,4)	MH8M36D -5	RAS, CAS cycling trc=twc=min. output open			1323	mA
		MH8M36D -6				1098	
		MH8M36D -7				963	
Icc2	Supply current from Vcc, stand-by	RAS= CAS =VIH, output open RAS= CAS ≥ Vcc-0.2			36	mA	
					10		
Icc3 (AV)	Average supply current from Vcc refreshing (Note 3)	RAS cycling, CAS= VIH trc=min. output open			2610	mA	
					2160		
					1890		
Icc4(AV)	Average supply current from Vcc Fast-Page-Mode (Note 3,4)	RAS=VIL, CAS cycling trc=min. output open			758	mA	
					648		
					558		
Icc6(AV)	Average supply current from Vcc CAS before RAS refresh mode (Note 3)	CAS before RAS refresh cycling trc=min. output open			2610	mA	
					2160		
					1890		

Note 2: Current flowing into an IC is positive, out is negative.

3: Icc1 (AV), Icc3 (AV), Icc4 (AV) and Icc6 (AV) are dependent on cycle rate. Maximum current is measured at the fastest cycle rate.

4: Icc1 (AV) and Icc4 (AV) are dependent on output loading. Specified values are obtained with the output open.

CAPACITANCE (Ta=0 ~ 70 °C, Vcc=5V ± 10%, Vss=0V, unless otherwise noted)

Symbol	Parameter	Test conditions	Limits			Unit
			Min	Typ	Max	
CI(A)	Input capacitance, address inputs	VI=Vss f=1MHz VI=25mVrms			145	pF
CI(W)	Input capacitance, write control input				189	pF
CI(RAS)	Input capacitance, RAS input				50	pF
CI(CAS)	Input capacitance, CAS input				50	pF
CI/O	Input/Output capacitance, data ports				22	pF

PRELIMINARY

MH8M36DJ/DNJ-5,-6,-7

FAST PAGE MODE 301989888-BIT (8388608 - WORD BY 36-BIT) DYNAMIC RAM MODULE

SWITCHING CHARACTERISTICS

(Ta=0 ~ 70 °C, Vcc=5V ± 10%, Vss=0V, unless otherwise noted, see notes 5,12,13)

Symbol	Parameter	Limits						Unit
		MH8M36D -5		MH8M36D -6		MH8M36D -7		
		Min	Max	Min	Max	Min	Max	
tCAC	Access time from CAS (Note 6,7)		13		15		20	ns
tRAC	Access time from RAS (Note 6,8)		50		60		70	ns
tAA	Column address access time (Note 6,9)		25		30		35	ns
tCPA	Access time from CAS precharge (Note 6,10)		30		35		40	ns
tCLZ	Output low impedance time from CAS low (Note 6)	5		5		5		ns
tOFF	Output disable time after CAS high (Note 11)	0	13	0	15	0	15	ns

Note 5: An initial pause of 500E s is required after power-up followed by a minimum of eight initialization cycles (any combination of cycles containing a RAS clock such as RAS-Only refresh).

Note the RAS may be cycled during the initial pause. And any 8 RAS or RAS/CAS cycles are required after prolonged periods (greater than 32 ms) of RAS inactivity before proper device operation is achieved.

6: Measured with a load circuit equivalent to 2TTL loads and 100pF.

7: Assumes that tACD ≥ tRCD(max) and tASC ≥ tASC(max).

8: Assumes that tACD ≤ tRCD(max) and tRAD ≤ tRAD(max). If tRCD or tRAD is greater than the maximum recommended value shown in this table, tRAC will increase by amount that tACD exceeds the value shown.

9: Assumes that tRAD ≥ tRAD(max) and tASC ≤ tASC(max).

10: Assumes that tCP ≤ tCP(max) and tASC ≥ tASC(max).

11: tOFF(max) and tOEZ (max) defines the time at which the output achieves the high impedance state (Iout ≤ ±10 μA) and is not reference to VOH(min) or VOL(max).

TIMING REQUIREMENTS (For Read, Write, Read-Modify-Write, Refresh, and Fast-Page Mode Cycles)

(Ta=0 ~ 70 °C, Vcc=5V ± 10%, Vss=0V, unless otherwise noted See notes 12,13)

Symbol	Parameter	Limits						Unit
		MH8M36D -5		MH8M36D -6		MH8M36D -7		
		Min	Max	Min	Max	Min	Max	
tREF	Refresh cycle time		32		32		32	ms
tRP	RAS high pulse width	30		40		50		ns
tRCD	Delay time, RAS low to CAS low (Note14)	18	37	20	45	20	50	ns
tCRP	Delay time, CAS high to RAS low	10		10		10		ns
tRPC	Delay time, RAS high to CAS low	0		0		0		ns
tCPN	CAS high pulse width	10		10		10		ns
tRAD	Column address delay time from RAS low (Note15)	13	25	15	30	15	35	ns
tASR	Row address setup time before RAS low	0		0		0		ns
tASC	Column address setup time before CAS low (Note16)	0	10	0	10	0	10	ns
tRAH	Row address hold time after RAS low	8		10		10		ns
tCAH	Column address hold time after CAS low	13		15		15		ns
tDZC	Delay time, data to CAS low	0		0		0		ns
tCDD	Delay time, CAS high to data	13		15		15		ns
tT	Transition time (Note17)	1	50	1	50	1	50	ns

Note 12: The timing requirements are assumed tr = 5ns.

13: VIH(min) and VIL(max) are reference levels for measuring timing of input signals.

14: tRCD(max) is specified as a reference point only. If tRCD is less than tRCD(max), access time is tRAC. If tRCD is greater than tRCD(max), access time is controlled exclusively by tCAC or tAA. tRCD(min) is specified as tRCD(min) = tRAH(min) + 2tH + tASC(min).

15: tRAD(max) is specified as a reference point only. If tRAD ≥ tRAD(max) and tASC ≤ tASC(max), access time is controlled exclusively by tAA.

16: tASC(max) is specified as a reference point only. If tRCD ≥ tRCD(max) and tASC ≥ tASC(max), access time is controlled exclusively by tCAC.

17: tT is measured between VIH(min) and VIL(max).

PRELIMINARY

MH8M36DJ/DNJ-5,-6,-7

FAST PAGE MODE 301989888-BIT (8388608 - WORD BY 36-BIT) DYNAMIC RAM MODULE

Read and Refresh Cycles

Symbol	Parameter	Limits						Unit
		MH8M36D -5		MH8M36D -6		MH8M36D -7		
		Min	Max	Min	Max	Min	Max	
trc	Read cycle time	90		110		130		ns
trAS	RAS low pulse width	50	10000	60	10000	70	10000	ns
tCAS	CAS low pulse width	13	10000	15	10000	20	10000	ns
tCSH	CAS hold time after RAS low	50		60		70		ns
trSH	RAS hold time after CAS low	13		15		20		ns
trCS	Read Setup time after CAS high	0		0		0		ns
trCH	Read hold time after CAS low (Note 18)	0		0		0		ns
trRH	Read hold time after RAS low (Note 18)	10		10		10		ns
trAL	Column address to RAS hold time	25		30		35		ns

Note 18: Either trCH or trRH must be satisfied for a read cycle.

Write Cycle (Early Write)

Symbol	Parameter	Limits						Unit
		MH8M36D -5		MH8M36D -6		MH8M36D -7		
		Min	Max	Min	Max	Min	Max	
tWC	Write cycle time	90		110		130		ns
trAS	RAS low pulse width	50	10000	60	10000	70	10000	ns
tCAS	CAS low pulse width	13	10000	15	10000	20	10000	ns
tCSH	CAS hold time after RAS low	50		60		70		ns
trSH	RAS hold time after CAS low	13		15		20		ns
twCS	Write setup time before CAS low (Note 22)	0		0		0		ns
twCH	Write hold time after CAS low	8		10		10		ns
tDS	Data setup time before CAS low or W low	0		0		0		ns
tDH	Data hold time after CAS low or W low	8		10		15		ns

PRELIMINARY

MH8M36DJ/DNJ-5,-6,-7

FAST PAGE MODE 301989888-BIT (8388608 - WORD BY 36-BIT) DYNAMIC RAM MODULE

Fast-Page Mode Cycle (Read, Early Write) (Note 19)

Symbol	Parameter	Limits						Unit
		MH8M36D -5		MH8M36D -6		MH8M36D -7		
		Min	Max	Min	Max	Min	Max	
t _{PC}	Fast page mode read/write cycle time	35		40		45		ns
t _{RAS}	RAS low pulse width for read write cycle (Note20)	85	125000	100	125000	115	125000	ns
t _{CP}	CAS high pulse width (Note21)	8	12	10	15	10	15	ns
t _{CPRH}	RAS hold time after CAS precharge	30		35		40		ns

Note 19: All previously specified timing requirements and switching characteristics are applicable to their respective fast page mode cycle.
 Note 20: t_{RAS(min)} is specified as two cycles of CAS input are performed.
 Note 21: t_{CP(max)} is specified as a reference point only.

CAS before RAS Refresh Cycle (Note 22)

Symbol	Parameter	Limits						Unit
		MH8M36D -5		MH8M36D -6		MH8M36D -7		
		Min	Max	Min	Max	Min	Max	
t _{CSR}	CAS setup time before RAS low	10		10		10		ns
t _{CHR}	CAS hold time after RAS low	10		10		15		ns
t _{RSR}	Read setup time before RAS low	10		10		10		ns
t _{RHR}	Read hold time after RAS low	10		10		15		ns

Note 22: Eight or more CAS before RAS cycles instead of eight RAS cycles are necessary for proper operation of CAS before RAS refresh mode.

PRELIMINARY

MH8M36DJ/DNJ-5,-6,-7

FAST PAGE MODE 301989888-BIT (8388608 - WORD BY 36-BIT) DYNAMIC RAM MODULE

Timing Diagrams (Note 23) Read Cycle

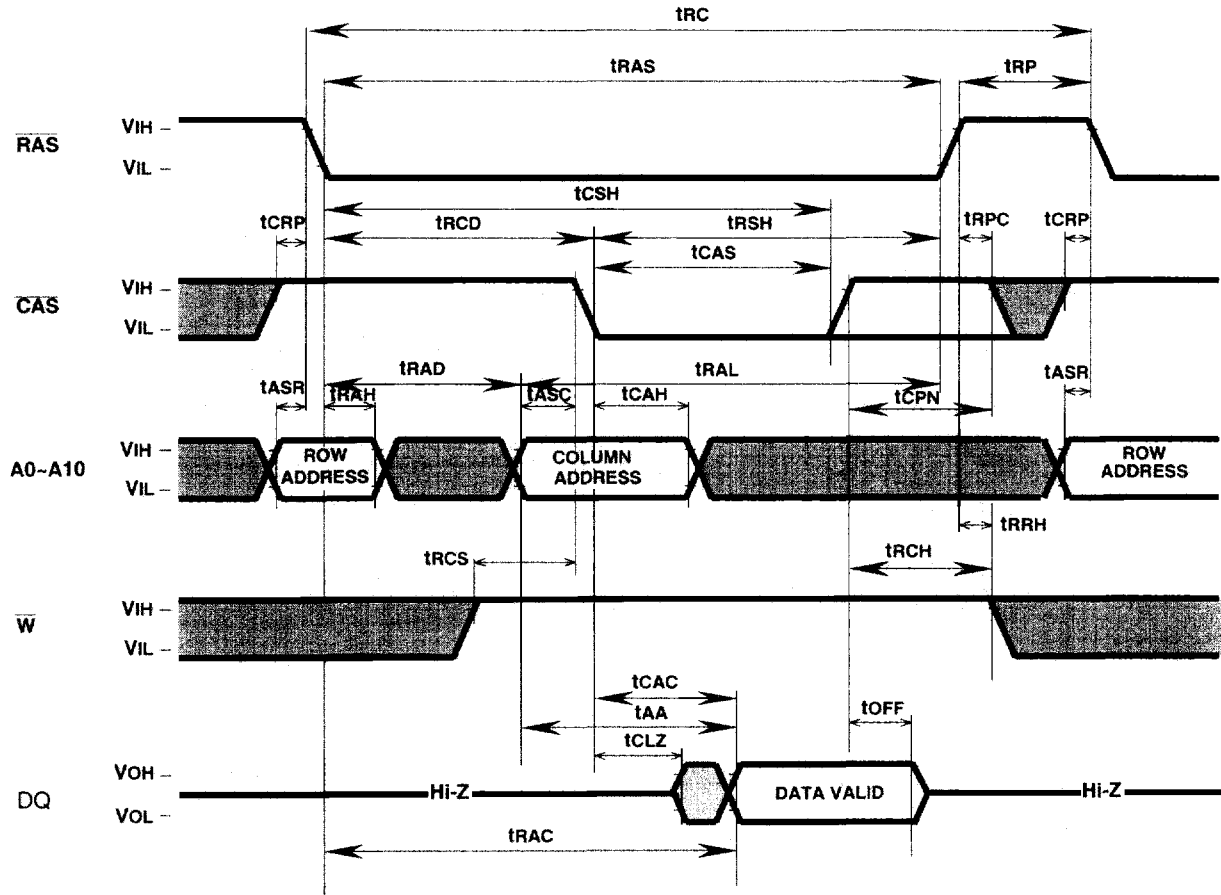

Note 23



Indicates the don't care input.

$V_{IH(min)} \leq V_{IN} \leq V_{IH(max)}$ or $V_{IL(min)} \leq V_{IN} \leq V_{IL(max)}$

Indicates the invalid output.

MH8M36DJ/DNJ-5,-6,-7

FAST PAGE MODE 301989888-BIT (8388608 - WORD BY 36-BIT) DYNAMIC RAM MODULE

Write Cycle (Early write)

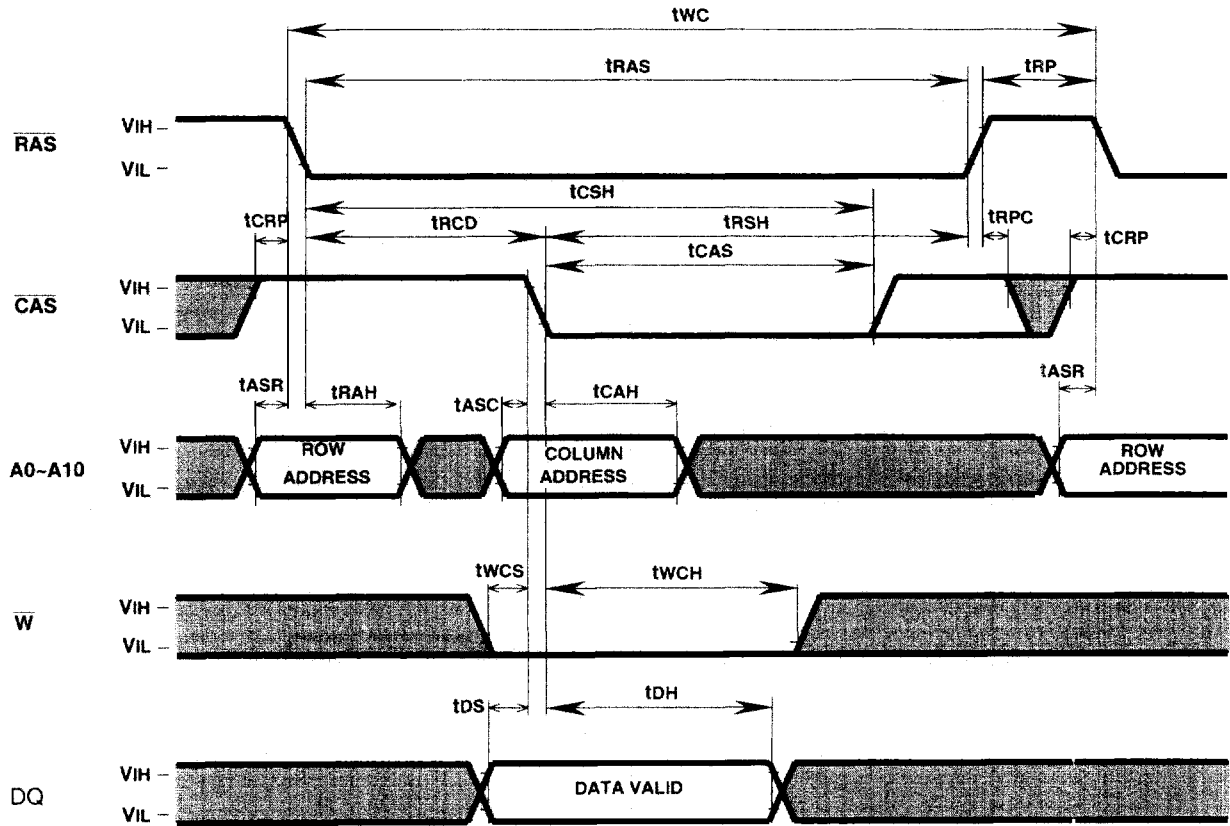

PRELIMINARY

MITSUBISHI LSIs

MH8M36DJ/DNJ-5,-6,-7

FAST PAGE MODE 301989888-BIT (8388608 - WORD BY 36-BIT) DYNAMIC RAM MODULE

RAS-only Refresh Cycle

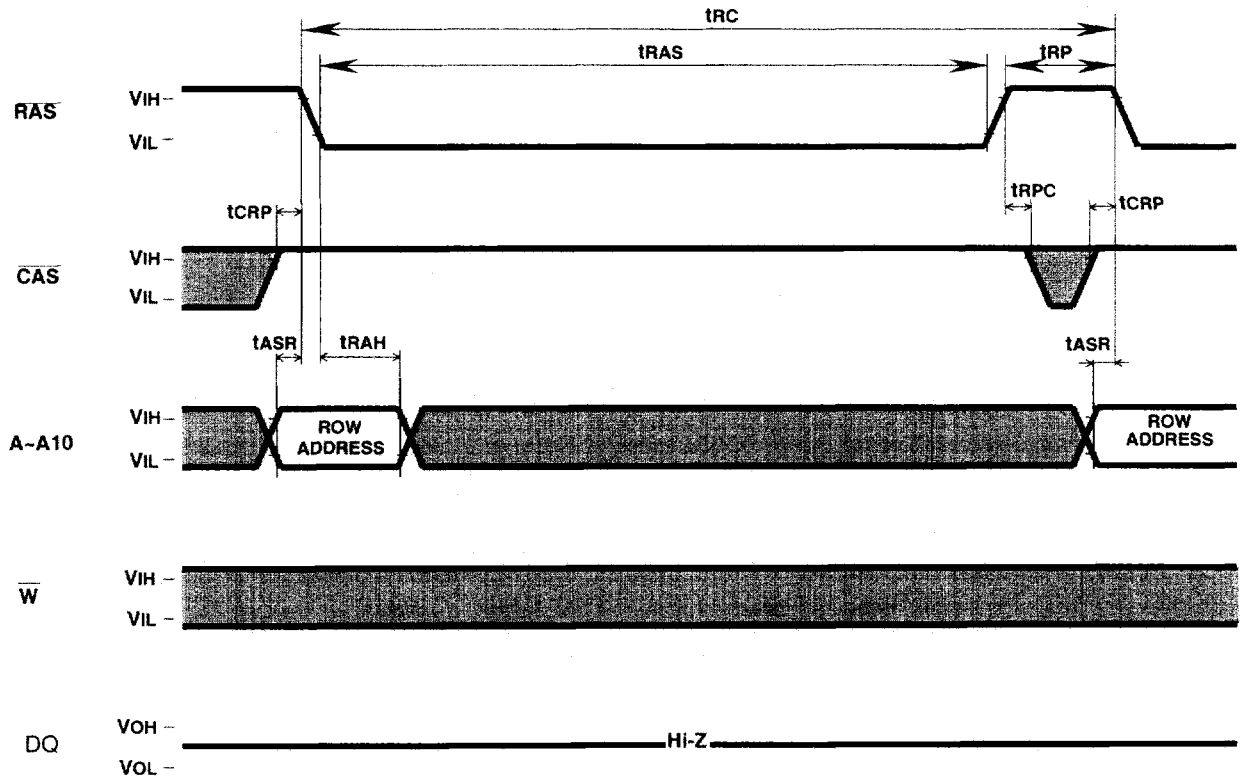

MH8M36DJ/DNJ-5,-6,-7

FAST PAGE MODE 301989888-BIT (8388608 - WORD BY 36-BIT) DYNAMIC RAM MODULE

CAS before RAS Refresh Cycle

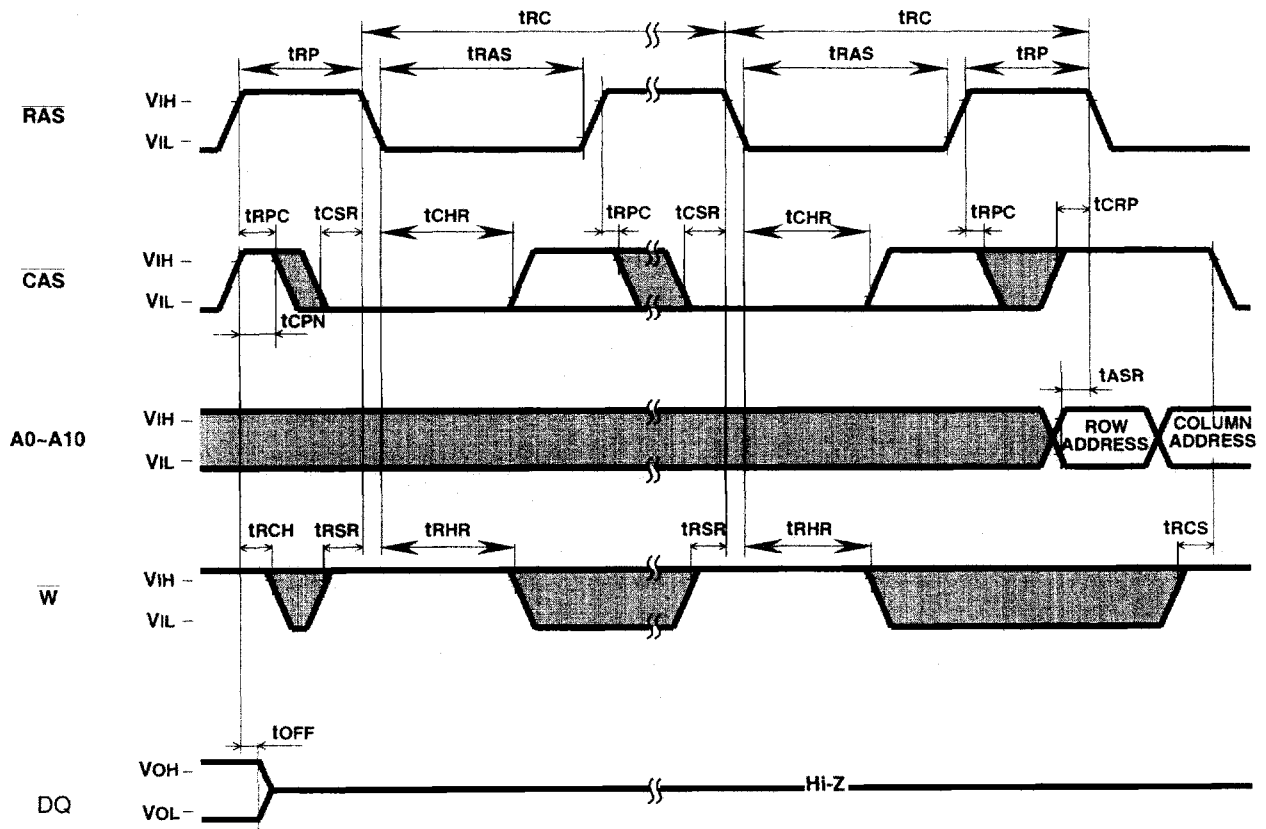

MH8M36DJ/DNJ-5,-6,-7

FAST PAGE MODE 301989888-BIT (8388608 - WORD BY 36-BIT) DYNAMIC RAM MODULE

Hidden Refresh Cycle (Read) (Note 28)

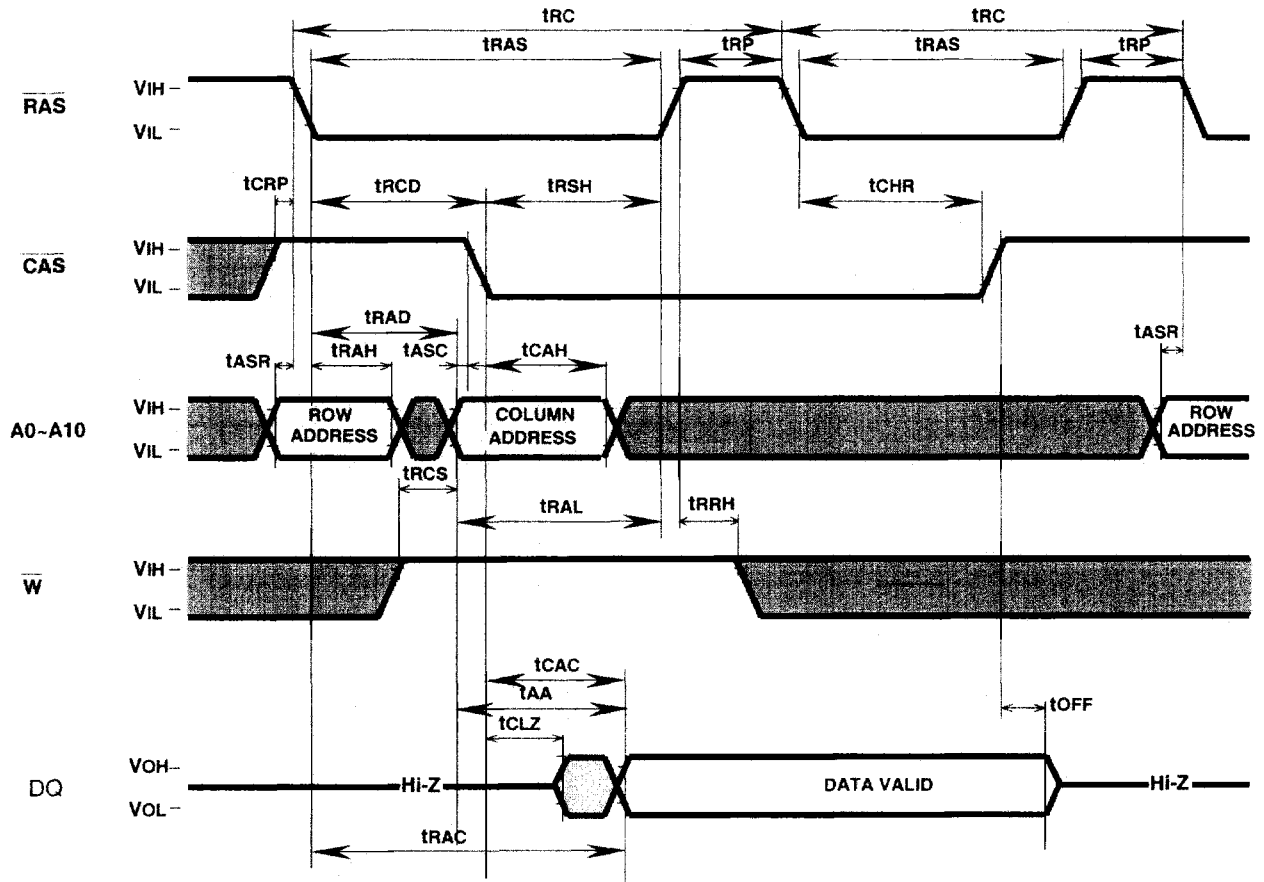

Note 28: Early write is applicable instead of read cycle.
Timing requirements and output state are the same as that of each cycle shown above.

PRELIMINARY

MH8M36DJ/DNJ-5,-6,-7

FAST PAGE MODE 301989888-BIT (8388608 - WORD BY 36-BIT) DYNAMIC RAM MODULE

Fast Page Mode Write Cycle (Early Write)

