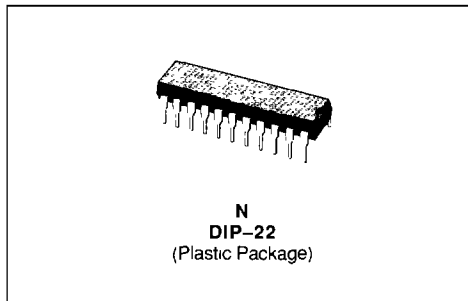
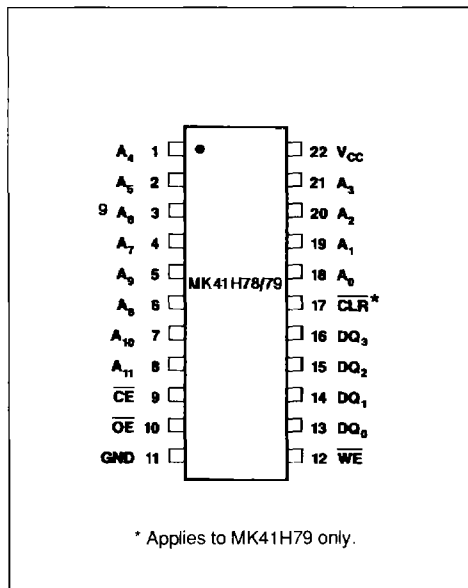

4K x 4 CMOS STATIC RAM

- 20, 25, AND 35ns ADDRESS ACCESS TIME
- EQUAL ACCESS AND CYCLE TIMES
- 22-PIN, 300 MIL PLASTIC
- ALL INPUTS AND OUTPUTS TTL COMPATIBLE, LOW CAPACITANCE, AND PROTECTED AGAINST STATIC DISCHARGE
- TTL STANDBY CURRENT UNAFFECTED BY ADDRESS ACTIVITY
- SEPARATE OUTPUT ENABLE CONTROL
- FLASH CLEAR FUNCTION

Figure 1 : Pin Connection.

DESCRIPTION

The MK41H78/79 features fully static operation requiring no external clocks or timing strobes, and equal address access and cycle times. It requires a single + 5V ± 10 percent power supply and is fully TTL compatible.

The device has a Chip Enable power down feature which automatically reduces power dissipation when the \overline{CE} pin is brought inactive (high). Standby power can be further reduced by raising the \overline{CE} pin to the full V_{CC} voltage. An Output Enable (\overline{OE}) pin provides a high speed tristate control, allowing fast read/write cycles to be achieved with the common I/O data bus.

Flash Clear operation is provided on the MK41H79 via the \overline{CLR} pin, and \overline{CE} active (low). A low applied to the \overline{CLR} pin clears all RAM bits to zero, making it especially useful for high speed cache and buffer storage applications.

PIN NAMES

$A_0 - A_{11}$ - Address	\overline{OE} - Output Enable
$DQ_0 - DQ_3$ - Data I/O	\overline{WE} - Write Enable
\overline{CLR} - Flash Clear	GND - Ground
\overline{CE} - Chip Enable	V_{CC} - + 5V

ABSOLUTE MAXIMUM RATINGS*

Parameter	Value	Unit
Voltage on any Pin Relative to GND	- 1.0 to + 7.0	V
Ambient Operating Temperature (T_A)	0 to 70	°C
Ambient Storage Temperature (plastic)	- 55 to + 125	°C
Ambient Storage Temperature (ceramic)	- 65 to + 150	°C
Total Device Power Dissipation	1	W
Output Current per Pin	50	mA

* Stresses greater than those listed under "Absolute Maximum Ratings" may cause permanent damage to the device. This is a stress rating only and functional operation of the device at these or other conditions beyond those indicated in the operational section of this specification is not implied. Exposure to absolute maximum rating conditions for extended periods of time may affect reliability.

TRUTH TABLE

\overline{CE}	\overline{OE}	\overline{WE}	CLR *	Mode	DQ	Power
H	X	X	X	Deselect	High Z	Standby
L	X	L	H	Write	D _{IN}	Active
L	L	H	H	Read	D _{OUT}	Active
L	H	H	H	Read	High Z	Active
L	X	L	L	Flash Clear	High Z	Active
L	L	H	L	Flash Clear	Low Z	Active
L	H	H	L	Flash Clear	High Z	Active

X = Don't Care

* Applies to MK41H79 only.

RECOMMENDED DC OPERATING CONDITIONS ($0^\circ\text{C} \leq T_A \leq 70^\circ\text{C}$)

Symbol	Parameter	Value			Unit	Notes
		Min.	Typ.	Max.		
V _{CC}	Supply Voltage	4.5	5.0	5.5	V	3
GND	Supply Voltage	0	0	0	V	
V _{IH}	Logic 1 Voltage, All Inputs	2.2		V _{CC} + 1.0	V	3
V _{IL}	Logic 0 Voltage, All Inputs	- 0.3		0.8	V	3

DC ELECTRICAL CHARACTERISTICS ($0^\circ\text{C} \leq T_A \leq 70^\circ\text{C}$) (V_{CC} = 5.0V ± 10 percent)

Symbol	Parameter	Value			Unit	Notes
		Min.	Typ.	Max.		
I _{CC1}	Average Power Supply Current			120	mA	4
I _{CC2}	TTL Standby Current			16	mA	5
I _{CC3}	CMOS Standby Current			8	mA	6
I _{IL}	Input Leakage Current (any input pin)	- 1		+ 1	μA	7
I _{OL}	Output Leakage Current (any output pin)	- 10		+ 10	μA	8
V _{OH}	Output Logic 1 Voltage (I _{OUT} = - 4 mA)	2.4			V	3
V _{OL}	Output Logic 0 Voltage (I _{OUT} = + 8 mA)			0.4	V	3

CAPACITANCE ($T_A = 25^\circ\text{C}$, $f = 1.0\text{MHz}$)

Symbol	Parameter	Value			Unit	Notes
		Min.	Typ.	Max.		
C_1	Capacitance on Input Pins	4		5	pF	9
C_2	Capacitance on DQ Pins	8		10	pF	9

- Notes :**
1. Measured with load shown in figure 2(A).
 2. Measured with load shown in figure 2(B).
 3. All voltages referenced to GND.
 4. I_{CC1} is measured as the average AC current with $V_{CC} = V_{CC}(\text{max})$ and with the outputs open circuit $t_{RC} = t_{RC}(\text{min})$ is used.
 5. $CE = V_{IH}$, all other inputs = Don't Care.
 6. $V_{CC}(\text{max}) \geq CE \geq V_{CC} - 0.3\text{V}$, all other inputs = Don't Care.
 7. Input leakage current specifications are valid for all V_{IN} such that $0\text{V} < V_{IN} < V_{CC}$. Measured at $V_{CC} = V_{CC}(\text{max})$.
 8. Output leakage current specifications are valid for all V_{OUT} such that $0\text{V} < V_{OUT} < V_{CC}$, $CE = V_{IH}$ and V_{CC} in valid

AC TEST CONDITIONS

- Input Levels GND to 3.0V
- Transition Times 5ns
- Input and Output Signal Timing Reference Level 1.5V
- Ambient Temperature 0°C to 70°C
- V_{CC} $5.0\text{V} \pm 10$ percent

Figure 2 : Output Load Circuits.

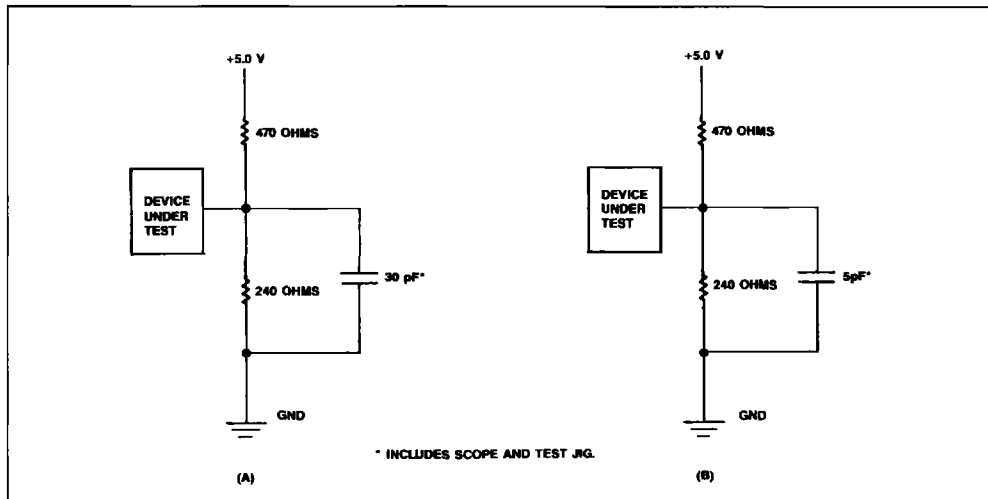

OPERATIONS

READ MODE

The MK41H78/79 is in the Read Mode whenever WE (Write Enable) is high and CE (Chip Enable) is low, providing a ripple-through access to data from four of 16,384 locations in the static storage array. The unique address specified by the 12 Address Inputs defines which one of 4096 nibbles of data is to be accessed.

Valid data will be available at the four Data Output pins within t_{AA} after the last address input signal is stable, providing that the CE and OE (output Enable) access times are satisfied. If CE or OE access times are not met, data access will be measured from the limiting parameter (t_{CEA} or t_{OEA}) rather than the address. The state of the four Data I/O pins is controlled by the CE, WE and OE control signals. The data lines may be in an indeterminate state at t_{CEL} and t_{OEL} , but the data lines will always have valid data at t_{AA} .

Figure 3 : Read-read-read-write Timing.

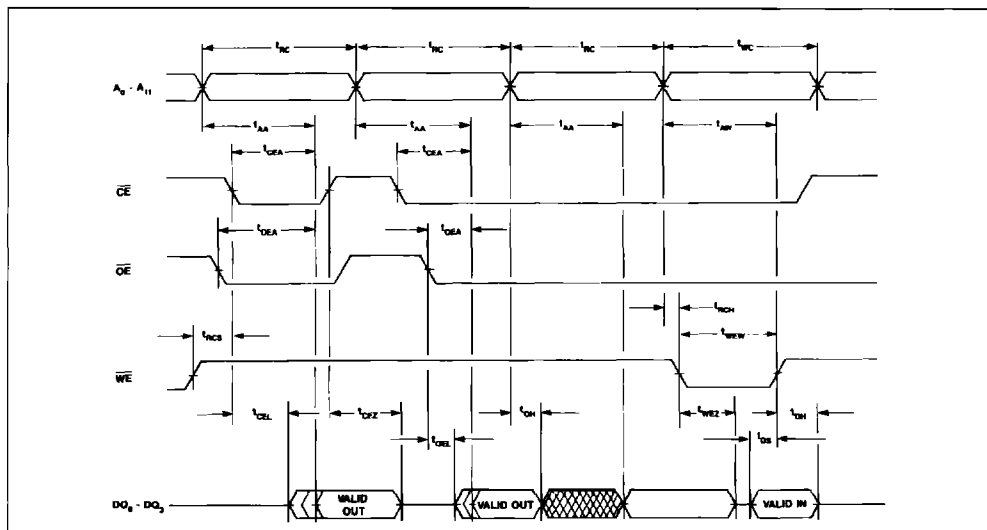

AC ELECTRICAL CHARACTERISTICS (read cycle timing)
 (0°C ≤ T_A ≤ 70°C) (V_{CC} = 5.0V ± 10 percent)

Symbol	Parameter	MK41H7X-20		MK41H7X-25		MK41H7X-35		Unit	Notes
		Min.	Max.	Min.	Max.	Min.	Max.		
t _{RC}	Read Cycle Time	20		25		35		ns	
t _{AA}	Address Access Time		20		25		35	ns	1
t _{CEL}	Chip Enable to Low-Z	7		7		7		ns	2
t _{CEA}	Chip Enable Access Time		20		25		35	ns	1
t _{OEL}	Output Enable to Low-Z	2		2		2		ns	2
t _{OEA}	Output Enable Access Time		10		12		15	ns	1
t _{RCS}	Read Command Setup Time	0		0		0		ns	
t _{RCH}	Read Command Hold Time	0		0		0		ns	
t _{OH}	Valid Data Out Hold Time	5		5		5		ns	1
t _{CEZ}	Chip Enable to High-Z		8		10		13	ns	2
t _{OEZ}	Output Enable to High-Z		7		8		10	ns	2
t _{WEZ}	Write Enable to High-Z		8		10		13	ns	2

WRITE MODE

The MK41H78/79 is in the Write Mode whenever the WE and CE inputs are in the low state. CE or WE must be high during address transitions. Addresses must be held valid throughout a write cycle. The Write begins with the concurrence of a low on WE and CE. Therefore, t_{AS} is referenced to the latter oc-

curing edge of \overline{CE} or WE. The write cycle is terminated by the earlier rising edge of CE or WE.

If the output is enabled (\overline{OE} and $\overline{O\overline{E}}$ low), then \overline{WE} will return the outputs to high impedance within t_{WEZ} of its falling edge. Care must be taken to avoid bus contention in this type of operation. Data-In must remain valid t_{DH} after the rising edge of CE or WE.

Figure 4 : Write–write–write–read Timing.

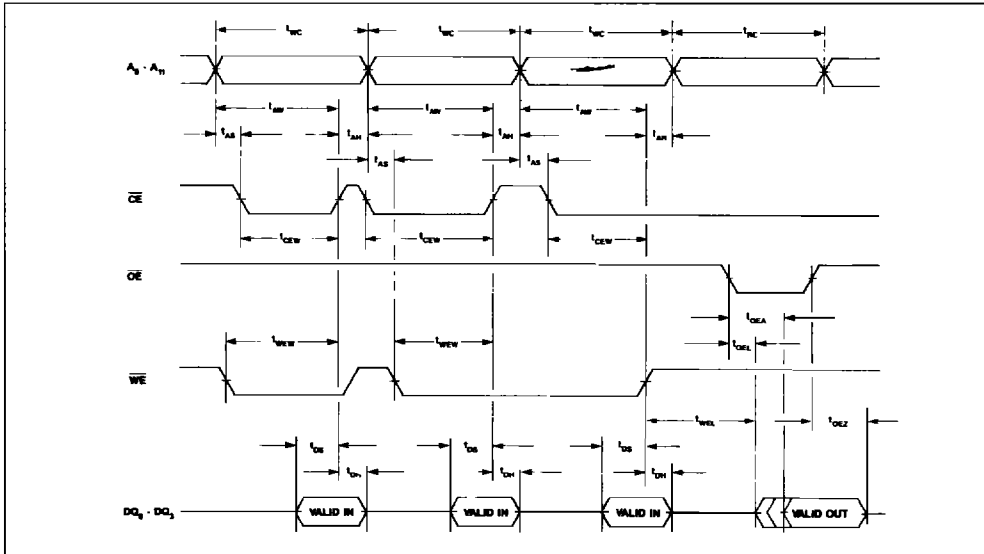

AC ELECTRICAL CHARACTERISTICS (write cycle timing)

($0^{\circ}\text{C} \leq T_A \leq 70^{\circ}\text{C}$) ($V_{CC} = 5.0\text{V} \pm 10\text{ percent}$)

Symbol	Parameter	MK41H7X-20		MK41H7X-25		MK41H7X-35		Unit	Notes
		Min.	Max.	Min.	Max.	Min.	Max.		
t_{WC}	Write Cycle Time	20		25		35		ns	
t_{AS}	Address Setup Time	0		0		0		ns	
t_{AW}	Address Stable to End of Write	16		20		30		ns	
t_{AH}	Address Hold after End of Write	0		0		0		ns	
t_{CEW}	Chip Enable to End of Write	18		22		32		ns	
t_{WEW}	Write Enable to End of Write	16		20		30		ns	
t_{DS}	Data Setup Time	12		14		15		ns	
t_{DH}	Data Hold Time	0		0		0		ns	
t_{WEL}	Write Enable to Low-Z	5		5		5		ns	2

FLASH CLEAR

A Flash Clear cycle sets all 16,384 bits in the RAM to logic zero. A Clear begins at the concurrence of a low on Chip Enable (\overline{CE}) and Flash Clear (\overline{CLR}). A Clear may be ended by a high on either \overline{CE} or \overline{CLR} . A low on \overline{CLR} has no effect if the device is dis-

abled (\overline{CE} high). A Clear may be executed within either a Read or a Write cycle. Figure 4 illustrates a Clear within a Read cycle. Clears within Write cycles are constrained only in that Write timing parameters must be observed as soon as the Flash Clear pin returns high.

Figure 5 : Last Read–flash Clear–first Write (MK41H79 only).

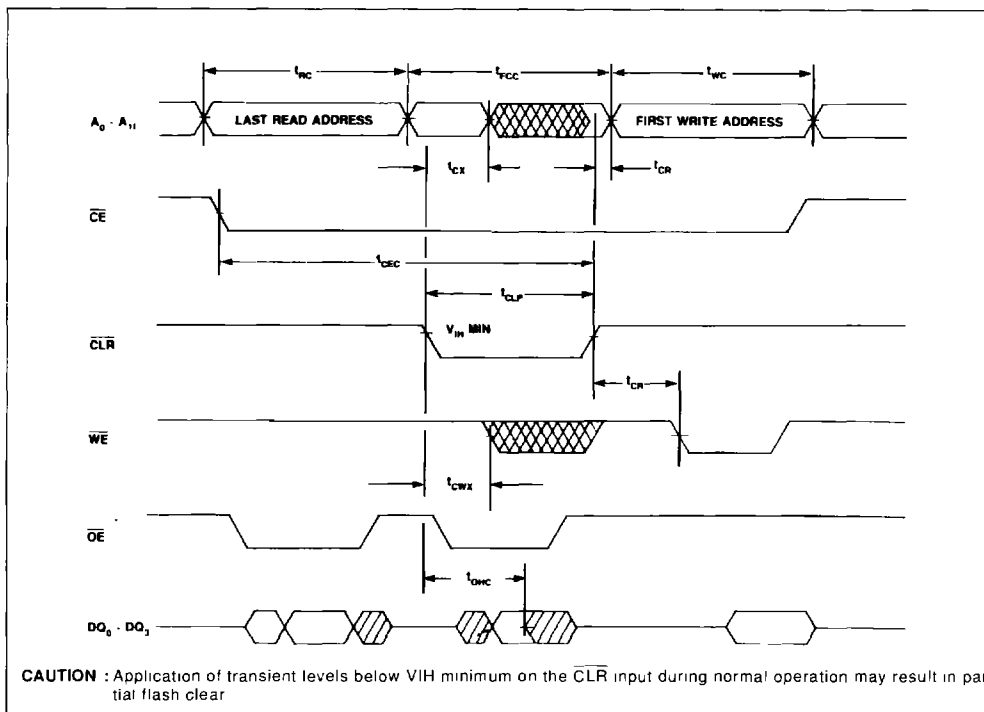

AC ELECTRICAL CHARACTERISTICS (clear cycle timing)
 ($0^{\circ}\text{C} \leq T_A \leq 70^{\circ}\text{C}$) ($V_{CC} = 5.0 \pm 10\%$)

Symbol	Parameter	MK41H7X-20		MK41H7X-25		MK41H7X-35		Unit	Notes
		Min.	Max.	Min.	Max.	Min.	Max.		
t_{FCC}	Flash Clear Cycle Time	40		50		70		ns	
t_{CEC}	Chip Enable Low to End of Clear	40		50		70		ns	
T_{CLP}	Flash Clear Low to End of Clear	38		48		68		ns	
t_{CX}	Clear to Inputs Don't Care	0		0		0		ns	
t_{CR}	End of Clear to Inputs Recognized	0		0		0		ns	
t_{CWx}	Clear to Write Enable Don't Care	0		0		0		ns	
t_{OHC}	Valid Data Out Hold from Clear	5		5		5		ns	1

STANDBY MODE

The MK41H78/79 is in Standby Mode whenever $\overline{\text{CE}}$ is held at or above V_{IH} .

Figure 6 : Standby Mode.

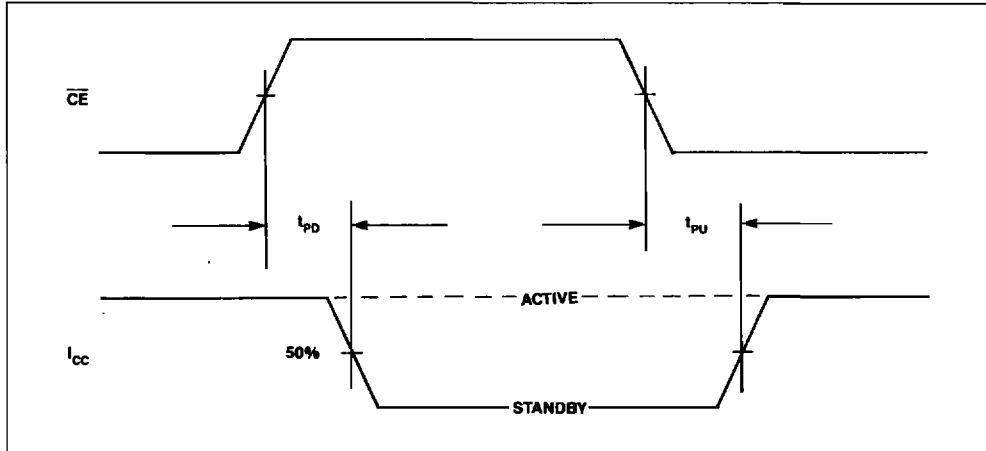

AC ELECTRICAL CHARACTERISTICS (standby mode)

($0^{\circ}\text{C} \leq T_{\text{A}} \leq 70^{\circ}\text{C}$) ($V_{\text{CC}} = 5.0\text{V} \pm 10\text{ percent}$)

Symbol	Parameter	MK41H7X-20		MK41H7X-25		MK41H7X-35		Unit	Notes
		Min.	Max.	Min.	Max.	Min.	Max.		
t_{PD}	Chip Enable High to Power Down		20		25		35	ns	
t_{PU}	Chip Enable Low to Power up	0		0		0		ns	

APPLICATION

The MK41H78/79 operates from a 5.0 volt supply. It is compatible with all standard TTL families on all inputs and outputs. The device should share a solid ground plane with any other devices interfaced with it, particularly TTL devices. Additionally, because the outputs can drive rail-to-rail into high impedance loads, the 41H79 can also interface to 5 volt CMOS on all inputs and outputs. Refer to the normalized performance curves that follow.

Since very high frequency current transients will be associated with the operation of the MK41H79, power line inductance must be minimized on the circuit board power distribution network. Power and ground tracegridding or separate power planes can be employed to reduce line inductance. Additionally, a high frequency decoupling capacitor should be

placed next to each RAM. The capacitor should be $0.1\mu\text{F}$ or larger. A pull-up resistor is also recommended for CLR on the MK41H79. This will ensure that any low going system noise, coupled onto the input, does not drive CLR below V_{IH} minimum specifications.

Though often times not thought of as such, the traces on a memory board are basically unterminated, low impedance transmission lines. As such they are subject to signal reflections manifested as noise, undershoots and excessive ringing. Series termination in close proximity to the TTL drivers can improve driver/signal path impedance matching. While experimentation most often proves to be the only practical approach to selection of series resistors, values in the range of 10 to 33Ω often prove most suitable.

NORMALIZED DC AND AC PERFORMANCE CHARACTERISTICS

NORMALIZED SUPPLY CURRENT VS. SUPPLY VOLTAGE $T_A = 0^\circ\text{C}$

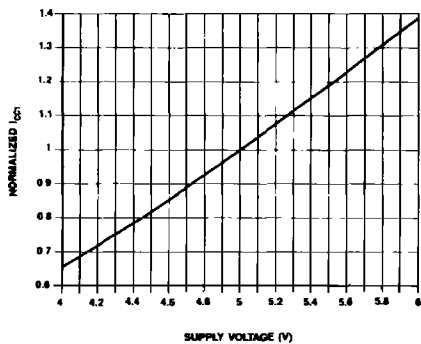

NORMALIZED SUPPLY CURRENT VS. AMBIENT TEMPERATURE $V_{CC} = 5.0\text{V}$

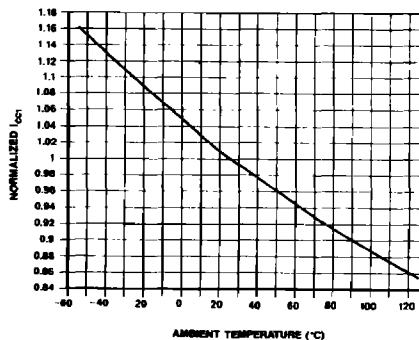

NORMALIZED SUPPLY CURRENT VS. CYCLE TIME $V_{CC} = 5.0\text{V}$ $T_A = 25^\circ\text{C}$

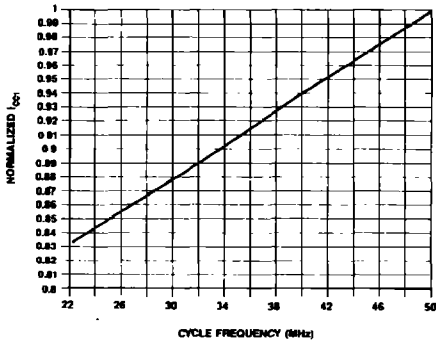

NORMALIZED ACCESS TIME VS. SUPPLY VOLTAGE $T_A = 25^\circ\text{C}$

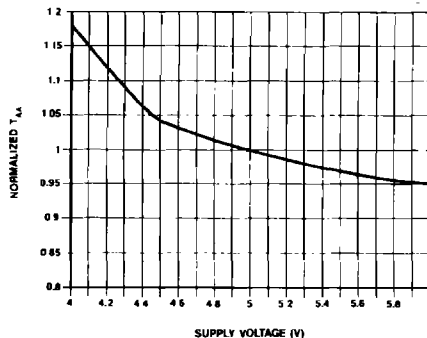

NORMALIZED ACCESS TIME VS. AMBIENT TEMPERATURE $V_{CC} = 5.0\text{V}$

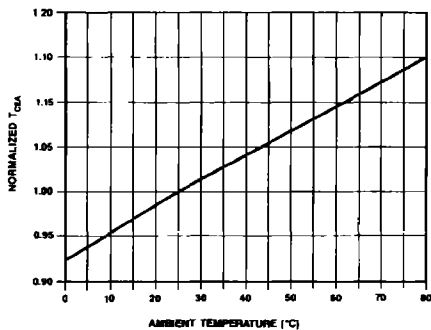

NORMALIZED ACCESS TIME VS. OUTPUT LOADING $V_{CC} = 5.0\text{V}$ $T_A = 25^\circ\text{C}$

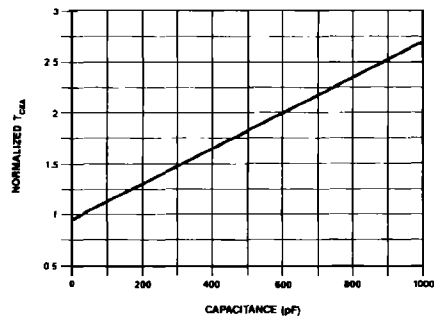

NORMALIZED DC AND AC PERFORMANCE CHARACTERISTICS

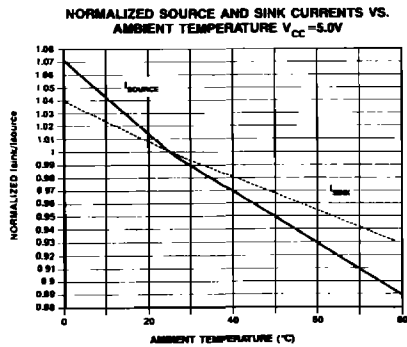
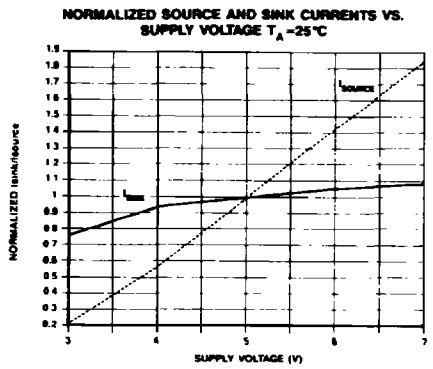
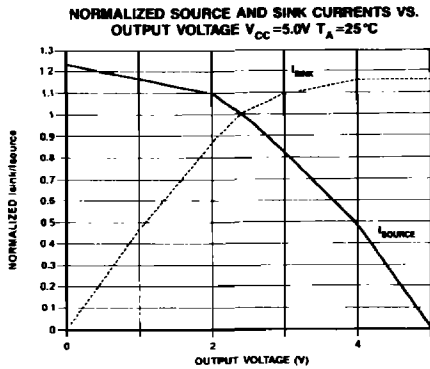
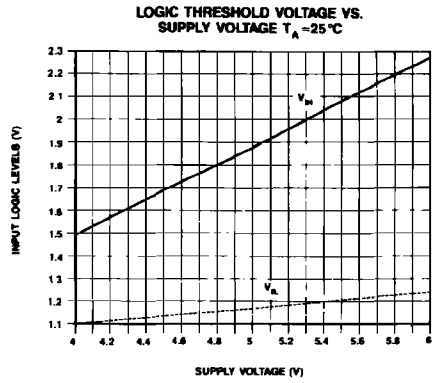
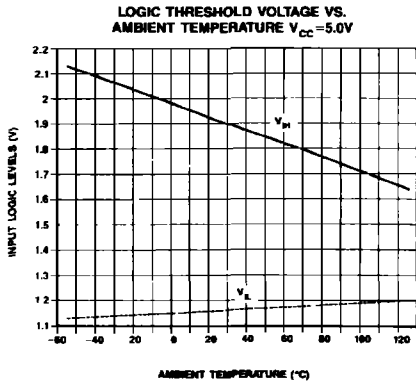

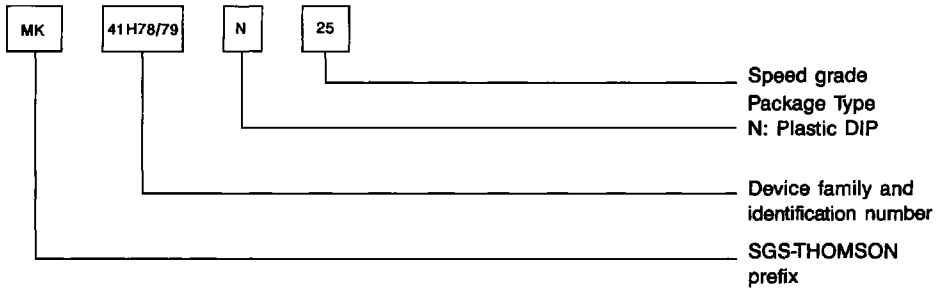

ORDER CODES

Part Number	Access Time	Package Type	Temperature Range
MK41H78N-20	20ns	22 Pin Plastic DIP	0°C to 70°C
MK41H78N-25	25ns	22 Pin Plastic DIP	0°C to 70°C
MK41H78N-35	35ns	22 Pin Plastic DIP	0°C to 70°C
MK41H79N-20	20ns	22 Pin Plastic DIP	0°C to 70°C
MK41H79N-25	25ns	22 Pin Plastic DIP	0°C to 70°C
MK41H79N-35	35ns	22 Pin Plastic DIP	0°C to 70°C

PACKAGE DESCRIPTION

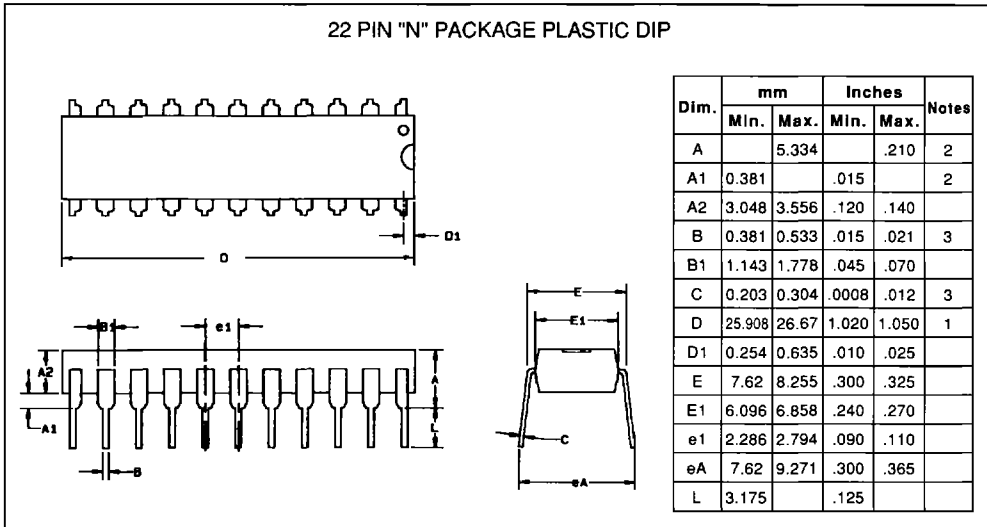

- Notes :
1. Overall length includes 010 in flash on either end of the package
 2. Package standoff to be measured per jedec requirements.
 3. The maximum limit shall be increased by 003 in when solder lead finish is specified.