

Advanced Power MOSFET

SSF22N50A

FEATURES

- Avalanche Rugged Technology
- Rugged Gate Oxide Technology
- Lower Input Capacitance
- Improved Gate Charge
- Extended Safe Operating Area
- Lower Leakage Current : 10 nA (Max.) @ $V_{DS} = 500V$
- Lower $R_{DS(ON)}$: 0.197 Ω (Typ.)

$$BV_{DSS} = 500 V$$

$$R_{DS(on)} = 0.25 \Omega$$

$$I_D = 12.4 A$$

TO-3PF

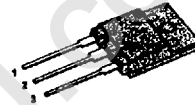

1.Gate 2. Drain 3. Source

Absolute Maximum Ratings

Symbol	Characteristic	Value	Units
V_{DSS}	Drain-to-Source Voltage	500	V
I_D	Continuous Drain Current ($T_c=25^\circ C$)	12.4	A
	Continuous Drain Current ($T_c=100^\circ C$)	7.8	
I_{DM}	Drain Current-Pulsed ①	88	A
V_{GS}	Gate-to-Source Voltage	± 0	V
E_{AS}	Single Pulsed Avalanche Energy ②	1708	mJ
I_{AR}	Avalanche Current ③	12.4	A
E_{AR}	Repetitive Avalanche Energy ③	10	mJ
dv/dt	Peak Diode Recovery dv/dt ③	3.5	V/ns
P_D	Total Power Dissipation ($T_c=25^\circ C$)	100	W
	Linear Derating Factor	0.8	
T_J, T_{STG}	Operating Junction and Storage Temperature Range	- 55 to +150	°C
T_L	Maximum Lead Temp. for Soldering Purposes, 1/8" from case for 5-seconds	300	

Thermal Resistance

Symbol	Characteristic	Typ.	Max.	Units
$R_{\theta JC}$	Junction-to-Case	--	1.25	°C/W
$R_{\theta JA}$	Junction-to-Ambient	--	40	



SSF22N50A

N-CHANNEL POWER MOSFET

Electrical Characteristics ($T_C=25^\circ\text{C}$ unless otherwise specified)

Symbol	Characteristic	Min.	Typ.	Max.	Units	Test Condition
BV_{DSS}	Drain-Source Breakdown Voltage	500	--	--	V	$V_{GS}=0V, I_D=250\mu A$
$\Delta BV/\Delta T_J$	Breakdown Voltage Temp. Coeff.	--	0.69	--	V/°C	$I_D=250\mu A$ See Fig 7
$V_{GS(th)}$	Gate Threshold Voltage	2.0	--	4.0	V	$V_{DS}=5V, I_D=250\mu A$
I_{GSS}	Gate-Source Leakage, Forward	--	--	100	nA	$V_{GS}=30V$
	Gate-Source Leakage, Reverse	--	--	-100	nA	$V_{GS}=-30V$
I_{DSS}	Drain-to-Source Leakage Current	--	--	10	μA	$V_{DS}=500V$
		--	--	100		$V_{DS}=400V, T_C=125^\circ\text{C}$
$R_{DS(on)}$	Static Drain-Source On-State Resistance	--	--	0.25	Ω	$V_{GS}=10V, I_D=6.2A$ ④
g_{fs}	Forward Transconductance	--	13.38	--	S	$V_{DS}=50V, I_D=6.2A$ ④
C_{iss}	Input Capacitance	--	3940	5120	pF	$V_{GS}=0V, V_{DS}=25V, f=1\text{MHz}$ See Fig 5
C_{oss}	Output Capacitance	--	465	535		
C_{rss}	Reverse Transfer Capacitance	--	215	250		
$t_{d(on)}$	Turn-On Delay Time	--	27	65	ns	$V_{DD}=250V, I_D=22A,$ $R_G=5.3\Omega$ See Fig 13 ④⑤
t_r	Rise Time	--	30	70		
$t_{d(off)}$	Turn-Off Delay Time	--	150	310		
t_f	Fall Time	--	43	95		
Q_g	Total Gate Charge	--	182	236	nC	$V_{DS}=400V, V_{GS}=10V,$ $I_D=22A$ See Fig 6 & Fig 12 ④⑤
Q_{gs}	Gate-Source Charge	--	26	--		
Q_{gd}	Gate-Drain("Miller") Charge	--	79.6	--		

Source-Drain Diode Ratings and Characteristics

Symbol	Characteristic	Min.	Typ.	Max.	Units	Test Condition
I_S	Continuous Source Current	--	--	12.4	A	Integral reverse pn-diode in the MOSFET
I_{SM}	Pulsed-Source Current ①	--	--	88		
V_{SD}	Diode Forward Voltage ④	--	--	1.4	V	$T_J=25^\circ\text{C}, I_S=12.4A, V_{GS}=0V$
t_{rr}	Reverse Recovery Time	--	528	--	ns	$T_J=25^\circ\text{C}, I_F=22A$
Q_{rr}	Reverse Recovery Charge	--	8.35	--	μC	$di_F/dt=100A/\mu s$ ④

Notes :

- ① Repetitive Rating : Pulse Width Limited by Maximum Junction Temperature
- ② $L=20\text{mH}, I_{AS}=12.4A, V_{DD}=50V, R_G=27\Omega$, Starting $T_J=25^\circ\text{C}$
- ③ $I_{SD} \leq 22A, di/dt \leq \dots A/\mu s, V_{DD} \leq BV_{DSS}$, Starting $T_J=25^\circ\text{C}$
- ④ Pulse Test : Pulse Width = $250\mu s$, Duty Cycle $\leq 2\%$
- ⑤ Essentially Independent of Operating Temperature

Fig 1. Output Characteristics

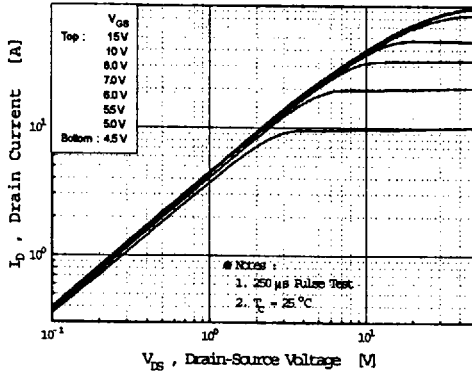

Fig 2. Transfer Characteristics

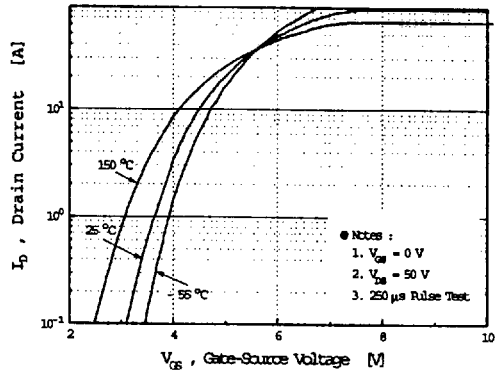

Fig 3. On-Resistance vs. Drain Current

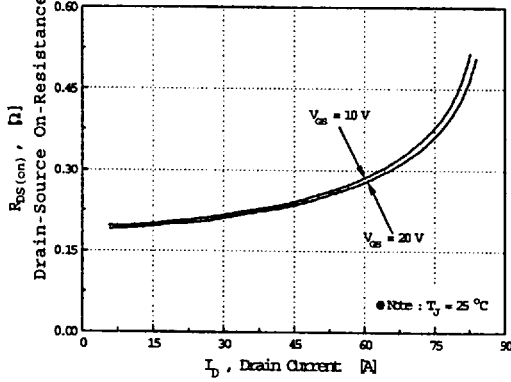

Fig 4. Source-Drain Diode Forward Voltage

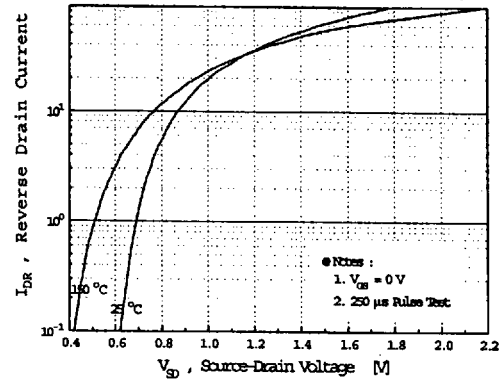

Fig 5. Capacitance vs. Drain-Source Voltage

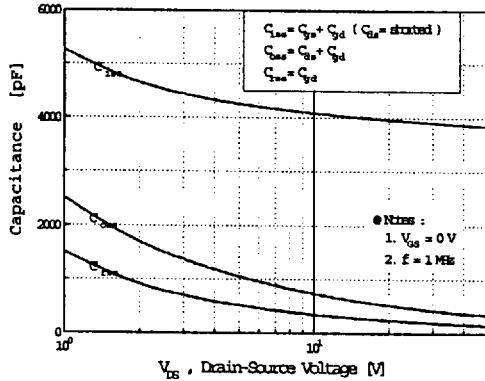
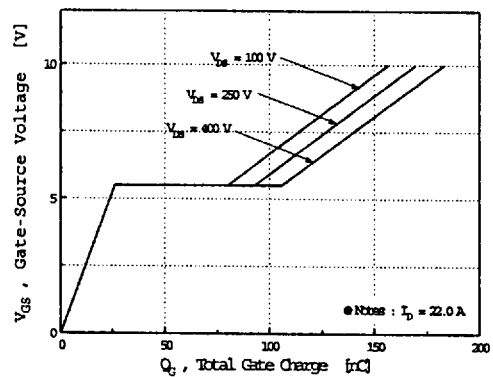

Fig 6. Gate Charge vs. Gate-Source Voltage



SSF22N50A

N-CHANNEL POWER MOSFET

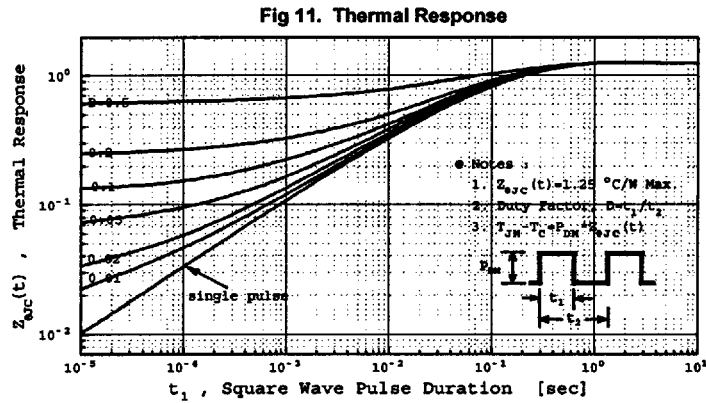
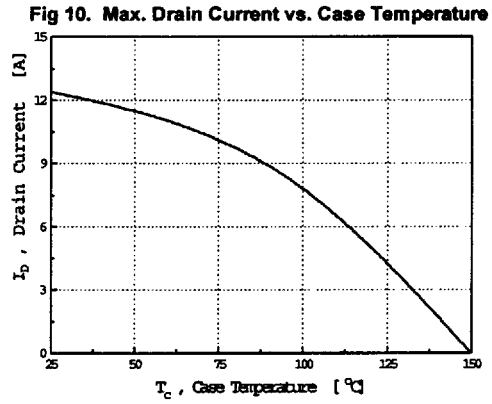
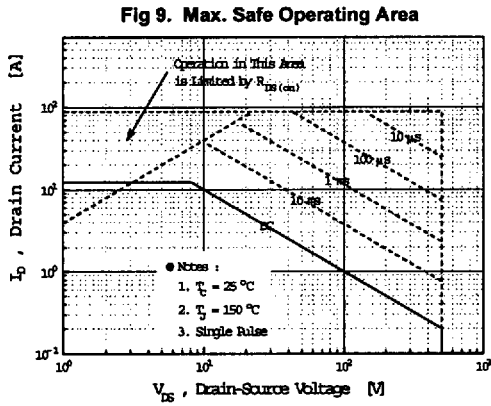
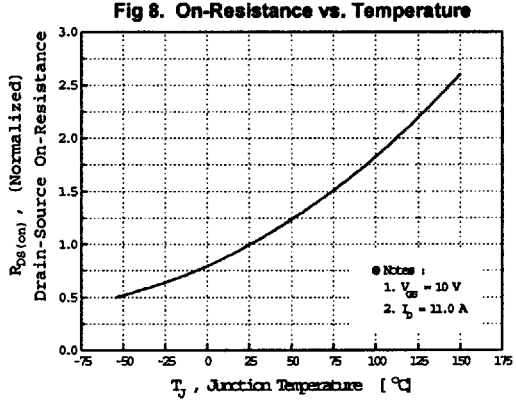
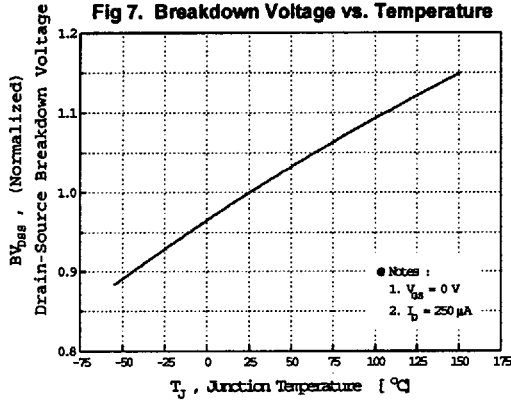

Fig 12. Gate Charge Test Circuit & Waveform

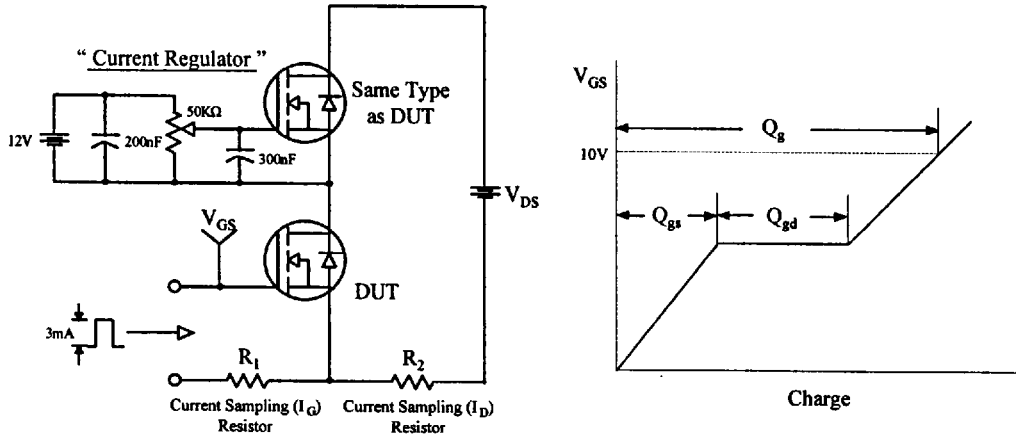

Fig 13. Resistive Switching Test Circuit & Waveforms

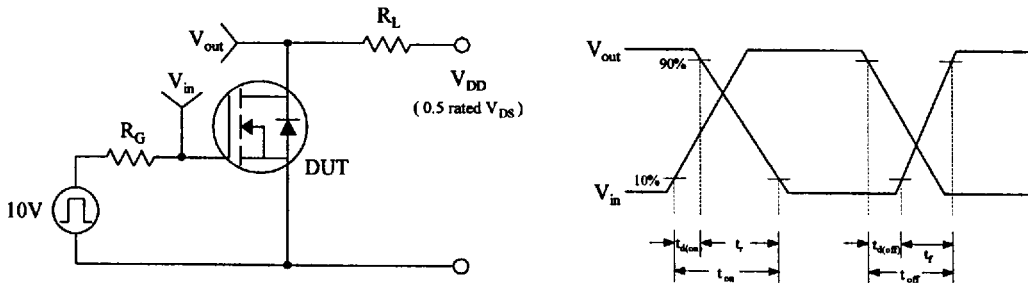

Fig 14. Unclamped Inductive Switching Test Circuit & Waveforms

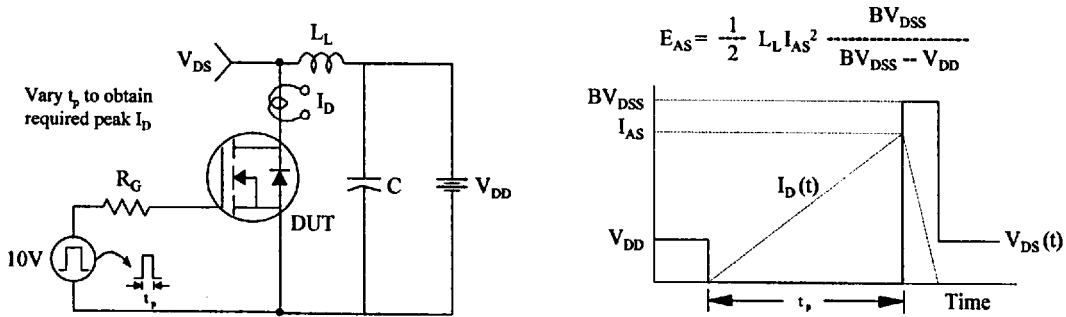
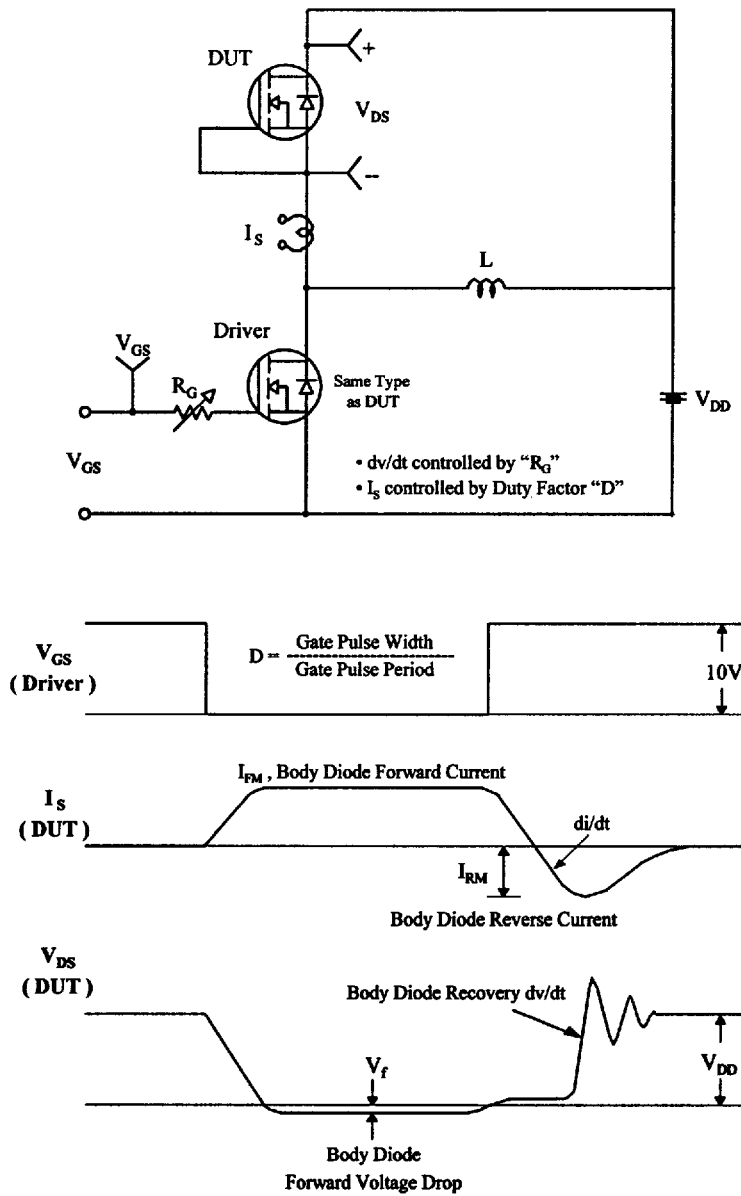
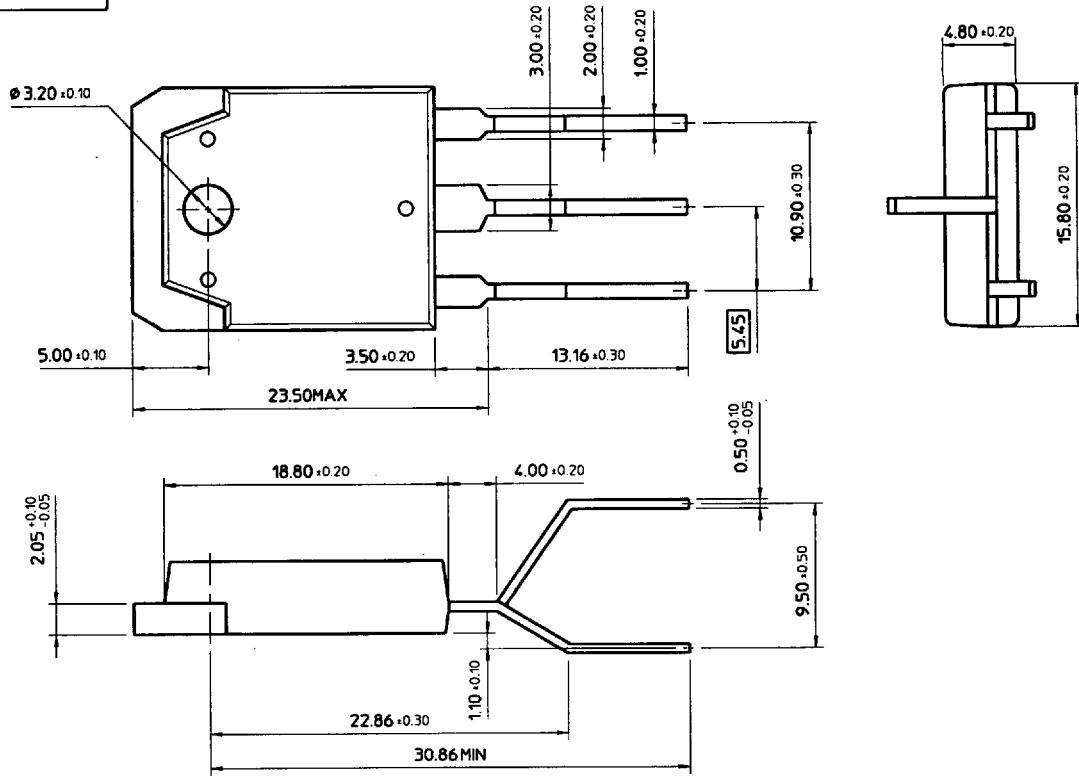

Fig 15. Peak Diode Recovery dv/dt Test Circuit & Waveforms



T0-3P (2)



T0-3PF (1)

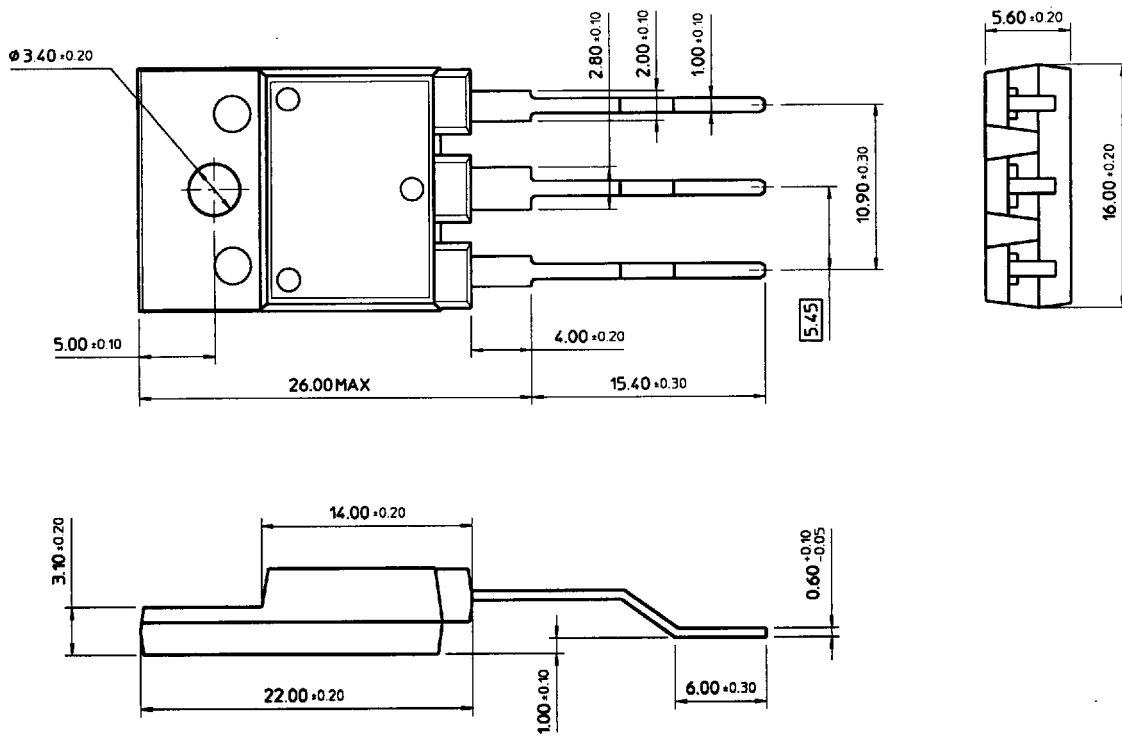

TO-3PF (2)

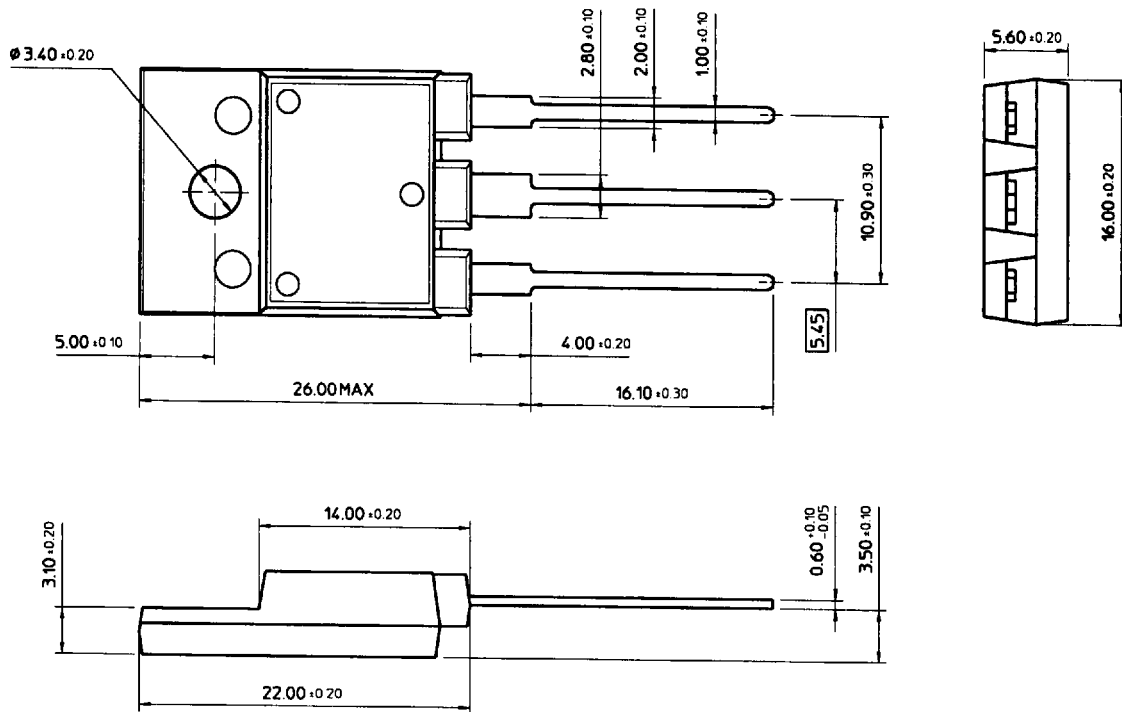

TO-3PF (3)

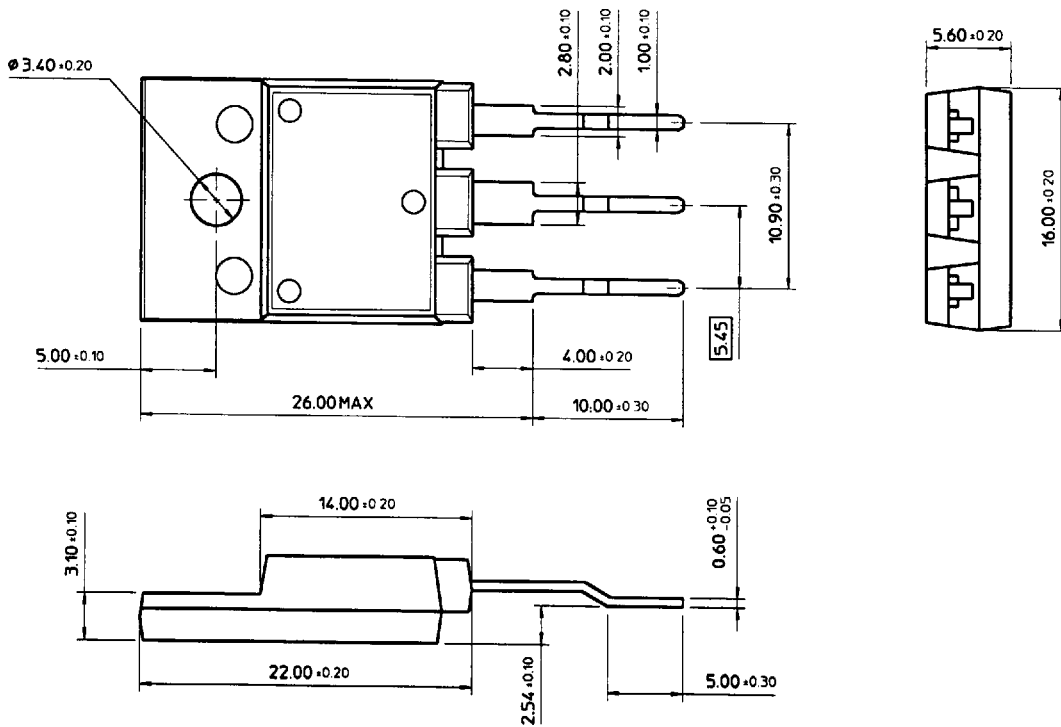

TO-3PF (4)

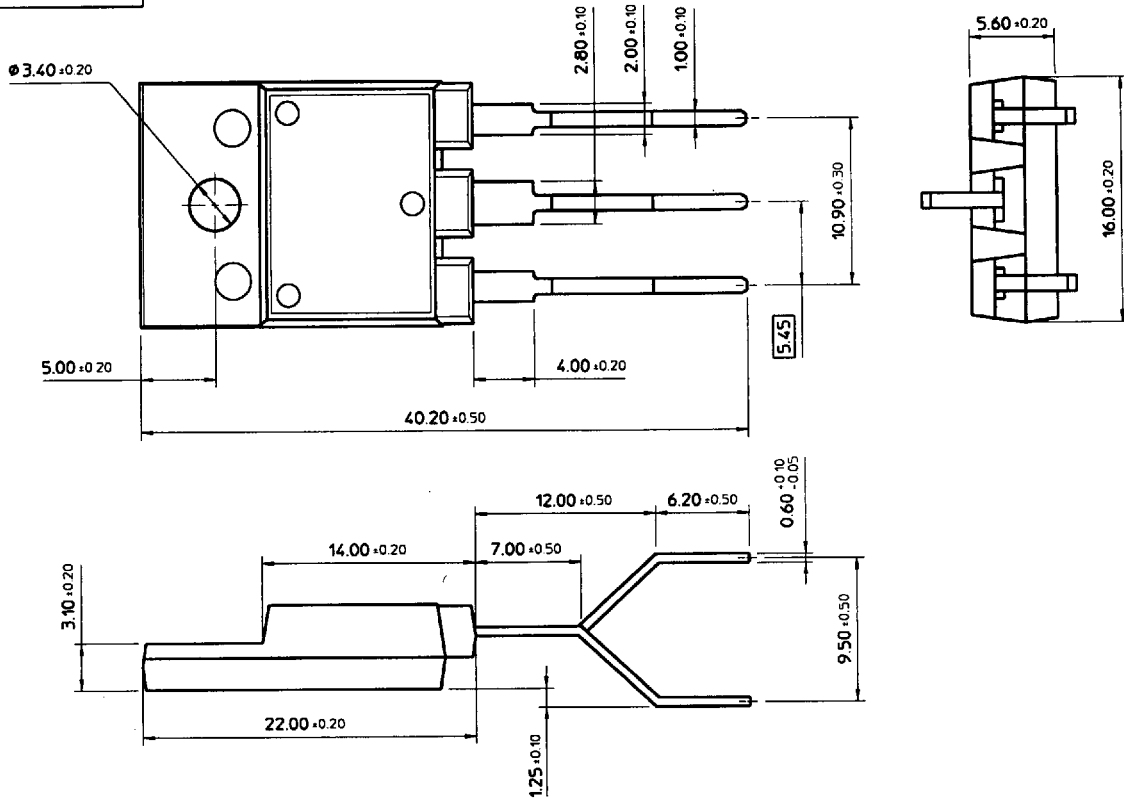

TO-3P-5L

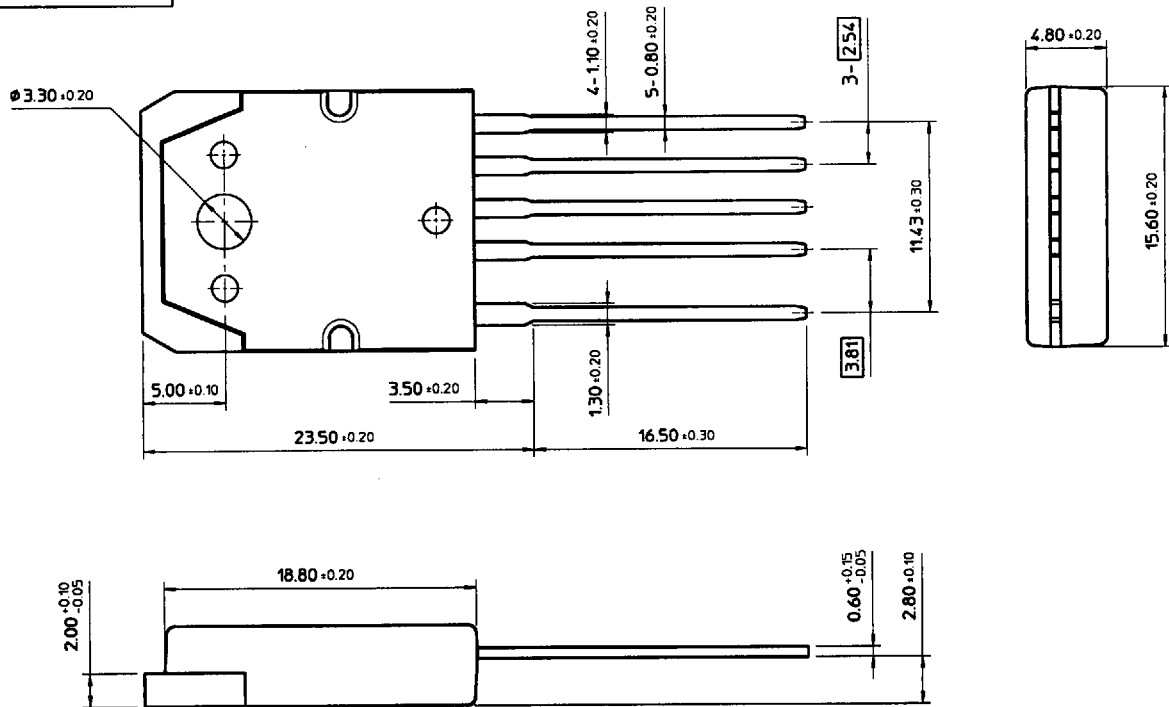

Under Development