

Surface Mount Microwave Schottky Mixer Diodes

Technical Data

HSMS-8101 Single
HSMS-8202 Series Pair
HSMS-8207 Ring Quad
HSMS-8209 Crossover Quad

Features

- Optimized for use at 10-14 GHz
- Low Capacitance
- Low Conversion Loss
- Low RD
- Low Cost Surface Mount Plastic Package
- Lead-free Option Available

Plastic SOT-23 Package

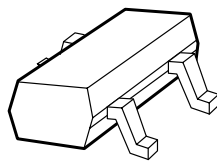

Plastic SOT-143 Package

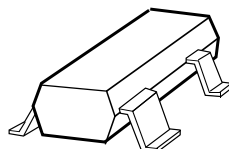

Description/Applications

These low cost microwave Schottky diodes are specifically designed for use at X/Ku-bands and are ideal for DBS and VSAT downconverter applications. They are available in SOT-23 and SOT-143 standard package configurations.

Note that Agilent's manufacturing techniques assure that dice found in pairs and quads are taken from adjacent sites on the wafer, assuring the highest degree of match.

Package Lead Code Identification (Top View)

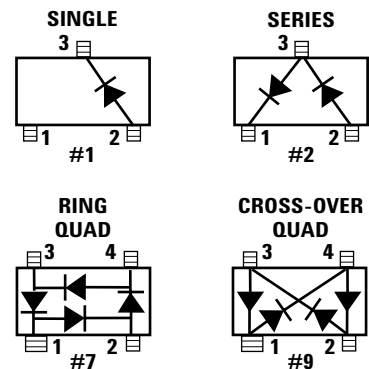

Absolute Maximum Ratings^[1], T_A = +25°C

Symbol	Parameter	Unit	Min.	Max.
P _T	Total Device Dissipation ^[2]	mW	—	75
P _{IV}	Peak Inverse Voltage	V	—	4
T _J	Junction Temperature	°C	—	+150
T _{STG} , T _{op}	Storage and Operating Temperature	°C	-65	+150

ESD WARNING:

Handling Precautions Should Be Taken To Avoid Static Discharge.

Notes:

1. Operation in excess of any one of these conditions may result in permanent damage to the device.
2. Measured in an infinite heat sink at T_{CASE} = 25°C. Derate linearly to zero at 150°C per diode.

DC Electrical Specifications, $T_A = 25^\circ\text{C}$

Symbol	Parameters and Test Conditions	Units	HSMS-8101		HSMS-8202		HSMS-8207		HSMS-8209	
			Min.	Max.	Min.	Max.	Min.	Max.	Min.	Max.
V_{BR}	Breakdown Voltage $I_R = 10 \mu\text{A}$	V	4		4		4		4	
C_T	Total Capacitance $V_R = 0 \text{ V}, f = 1 \text{ MHz}$	pF		0.26		0.26		0.26		0.26
ΔC_T	Capacitance Difference $V_R = 0 \text{ V}, f = 1 \text{ MHz}$	pF		—		0.04		0.04		0.04
R_D	Dynamic Resistance $I_F = 5 \text{ mA}$	Ω		14		14		14		14
ΔR_D	Dynamic Resistance Difference $I_F = 5 \text{ mA}$	Ω		—		2		2		2
V_F	Forward Voltage $I_F = 1 \text{ mA}$	mV	250	350	250	350	250	350	250	350
ΔV_F	Forward Voltage Difference $I_F = 1 \text{ mA}$	mV		—		20		20		20
Lead Code			1		2		7		9	
Package Marking Code in White where x is date code			R1x		2Rx		R7x		R9x	

RF Electrical Parameters, $T_A = 25^\circ\text{C}$

Symbol	Parameter	Units	Typical
L_c	Conversion Loss at 12 GHz	dB	6.3
Z_{IF}	IF Impedance	Ω	150
SWR	SWR at 12 GHz		1.2

Note:

DC Load Resistance = 0 Ω ; LO Power = 1 mW.

SPICE Parameters

$I_S = 4.6 \text{ E-}8$	$E_G = 0.69$	$TT = 0$
$R_S = 6$	$C_{JO} = 0.18 \text{ E-}12$	
$N = 1.09$	$P_B (V_J) = 0.5$	
$B_V = 7.3$	$M = 0.5$	
$I_{BV} = 10\text{E-}5$	$FC = 0.5$	

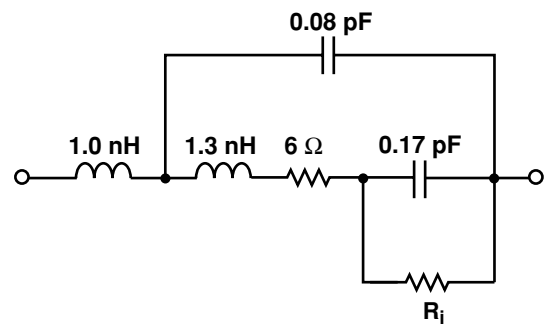
Linear Equivalent Circuit**Self Bias**

	1 mA	2.5 mA
R_j	263	142

Typical Performance, $T_C = 25^\circ\text{C}$

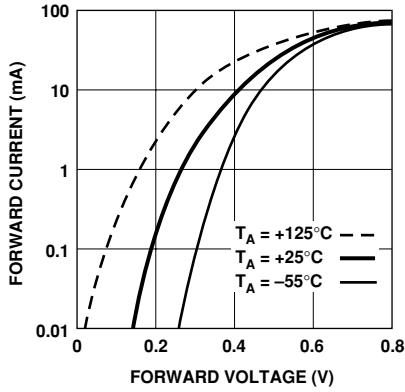

Figure 1. Typical Forward Current vs. Forward Voltage at Three Temperatures.

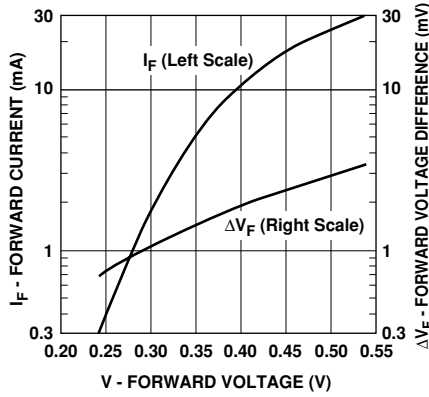

Figure 2. Typical VF Match, HSMS-820X Pairs and Quads.

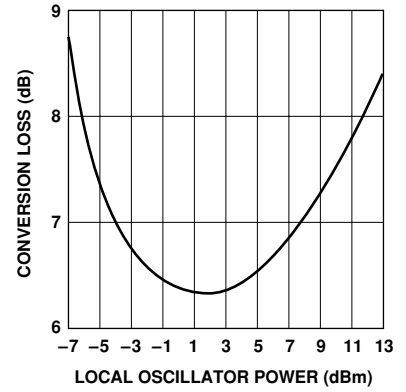
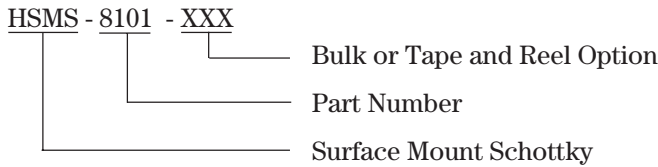

Figure 3. Typical Conversion Loss vs. Local Oscillator Power.

Ordering Information

Specify part number followed by option. For example:



Profile Option Descriptions

- BLK = Bulk
- TR1 = 3K pc. Tape and Reel, Device Orientation Figures 4, 5
- TR2 = 10K pc. Tape and Reel, Device Orientation Figures 4, 5

Tape and Reeling conforms to Electronic Industries RS-481, "Taping of Surface Mounted Components for Automated Placement."

For lead-free option, the part number will have the character "G" at the end, eg. -TR2G for a 10K pc lead-free reel.

Device Orientation

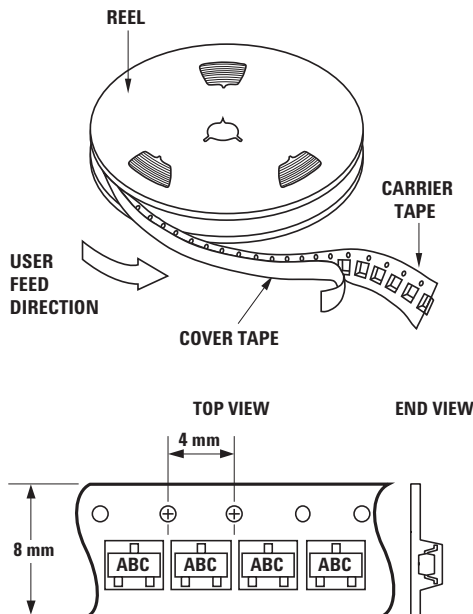

Note: "AB" represents package marking code.
"C" represents date code.

Figure 4. Option -TR1/-TR2 for SOT-23 Packages.

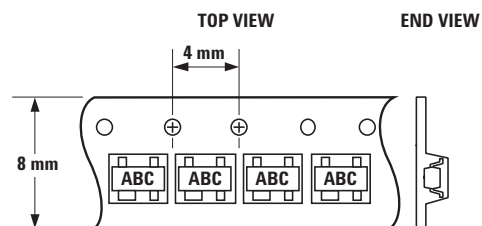

Note: "AB" represents package marking code.
"C" represents date code.

Figure 5. Option -TR1/-TR2 for SOT-143 Packages.

Package Characteristics

Lead Material	Alloy 42
Lead Finish	Tin-Lead 85-15%
Maximum Soldering Temperature	260°C for 5 seconds
Minimum Lead Strength	2 pounds pull
Typical Package Inductance	2 nH
Typical Package Capacitance	0.08 pF (opposite leads)

Package Dimensions Outline 23 (SOT-23)

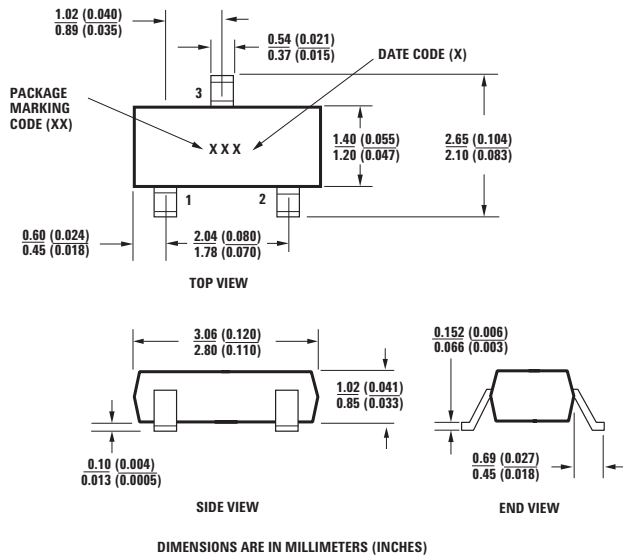

Outline 143 (SOT-143)

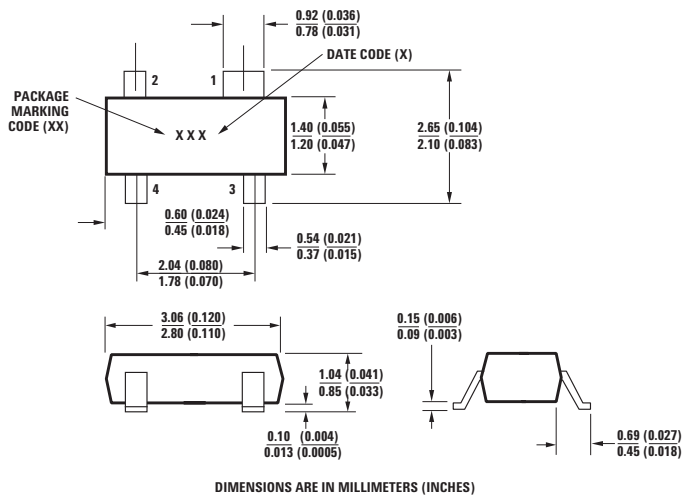

Tape Dimensions and Product Orientation For Outline SOT-23

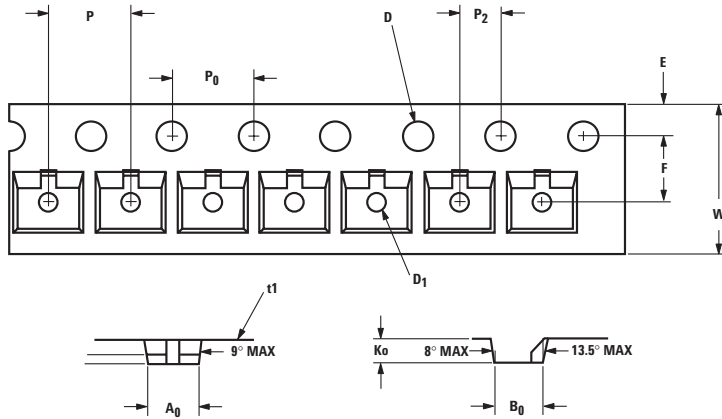

DESCRIPTION		SYMBOL	SIZE (mm)	SIZE (INCHES)
CAVITY	LENGTH	A ₀	3.15 ± 0.10	0.124 ± 0.004
	WIDTH	B ₀	2.77 ± 0.10	0.109 ± 0.004
	DEPTH	K ₀	1.22 ± 0.10	0.048 ± 0.004
	PITCH	P	4.00 ± 0.10	0.157 ± 0.004
	BOTTOM HOLE DIAMETER	D ₁	1.00 + 0.05	0.039 ± 0.002
PERFORATION	DIAMETER	D	1.50 + 0.10	0.059 + 0.004
	PITCH	P ₀	4.00 ± 0.10	0.157 ± 0.004
	POSITION	E	1.75 ± 0.10	0.069 ± 0.004
CARRIER TAPE	WIDTH	W	8.00 + 0.30 - 0.10	0.315 + 0.012 - 0.004
	THICKNESS	t ₁	0.229 ± 0.013	0.009 ± 0.0005
DISTANCE BETWEEN CENTERLINE	CAVITY TO PERFORATION (WIDTH DIRECTION)	F	3.50 ± 0.05	0.138 ± 0.002
	CAVITY TO PERFORATION (LENGTH DIRECTION)	P ₂	2.00 ± 0.05	0.079 ± 0.002

For Outline SOT-143

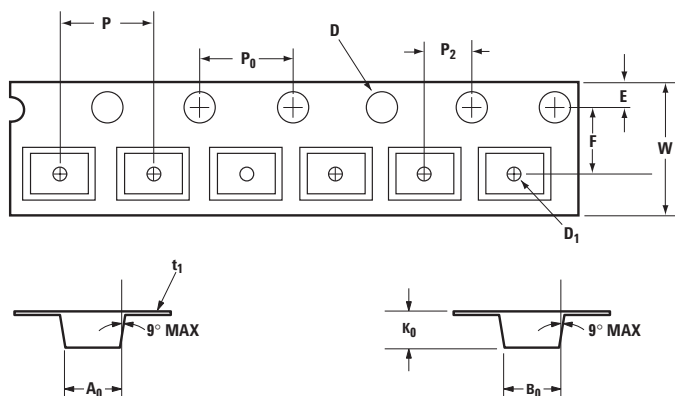

DESCRIPTION		SYMBOL	SIZE (mm)	SIZE (INCHES)
CAVITY	LENGTH	A ₀	3.19 ± 0.10	0.126 ± 0.004
	WIDTH	B ₀	2.80 ± 0.10	0.110 ± 0.004
	DEPTH	K ₀	1.31 ± 0.10	0.052 ± 0.004
	PITCH	P	4.00 ± 0.10	0.157 ± 0.004
	BOTTOM HOLE DIAMETER	D ₁	1.00 + 0.25	0.039 + 0.010
	PERFORATION	DIAMETER	D	1.50 + 0.10
PITCH		P ₀	4.00 ± 0.10	0.157 ± 0.004
POSITION		E	1.75 ± 0.10	0.069 ± 0.004
CARRIER TAPE	WIDTH	W	8.00 + 0.30 - 0.10	0.315 + 0.012 - 0.004
	THICKNESS	t ₁	0.254 ± 0.013	0.0100 ± 0.0005
DISTANCE	CAVITY TO PERFORATION (WIDTH DIRECTION)	F	3.50 ± 0.05	0.138 ± 0.002
	CAVITY TO PERFORATION (LENGTH DIRECTION)	P ₂	2.00 ± 0.05	0.079 ± 0.002

www.agilent.com/semiconductors

For product information and a complete list of distributors, please go to our web site.

For technical assistance call:

Americas/Canada: +1 (800) 235-0312 or (916) 788-6763

Europe: +49 (0) 6441 92460

China: 10800 650 0017

Hong Kong: (65) 6756 2394

India, Australia, New Zealand: (65) 6755 1939

Japan: (+81 3) 3335-8152(Domestic/International), or 0120-61-1280(Domestic Only)

Korea: (65) 6755 1989

Singapore, Malaysia, Vietnam, Thailand, Philippines, Indonesia: (65) 6755 2044

Taiwan: (65) 6755 1843

Data subject to change.

Copyright © 2004 Agilent Technologies, Inc.

Obsoletes 5988-3328EN

March 24, 2004

5989-0481EN