

# NE521

## High-Speed Dual-Differential Comparator/Sense Amp

### Features

- TTL-Compatible Strobes and Outputs
- Large Common-Mode Input Voltage Range
- Operates from Standard Supply Voltages
- Pb-Free Packages are Available

### Applications

- MOS Memory Sense Amp
- A-to-D Conversion
- High-Speed Line Receiver

### MAXIMUM RATINGS

Rating	Symbol	Value	Unit
Supply Voltage Positive Negative	V <sub>+</sub> V <sub>-</sub>	+7.0 -7.0	V
Differential Input Voltage	V <sub>IDR</sub>	±6.0	V
Input Voltage Common Mode Strobe/Gate	V <sub>IN</sub>	±5.0 +5.25	V
Maximum Power Dissipation (Note 1) T <sub>A</sub> = 25°C (Still-Air)	P <sub>D</sub>		mW
	N Package	1420	
	D Package	1040	
Thermal Resistance, Junction-to-Ambient	R <sub>θJA</sub>		°C/W
	N Package	100	
	D Package	145	
Operating Temperature Range	T <sub>A</sub>	0 to 70	°C
Storage Temperature Range	T <sub>stg</sub>	-65 to +150	°C
Operating Junction Temperature	T <sub>J</sub>	150	°C
Lead Soldering Temperature (10 sec max)	T <sub>slid</sub>	+230	°C

Stresses exceeding Maximum Ratings may damage the device. Maximum Ratings are stress ratings only. Functional operation above the Recommended Operating Conditions is not implied. Extended exposure to stresses above the Recommended Operating Conditions may affect device reliability.

1. Derate above 25°C at the following rates:

- N package at 10 mW/°C
- D package at 6.9 mW/°C.



ON Semiconductor®

<http://onsemi.com>

### MARKING DIAGRAMS

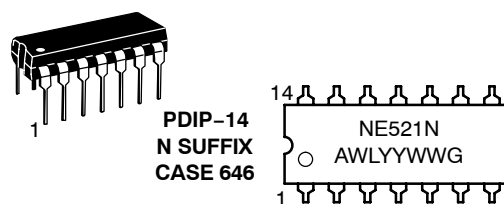
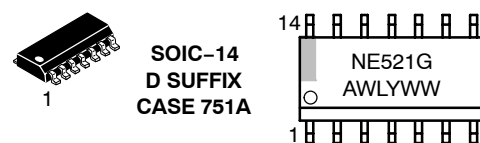

A = Assembly Location  
WL = Wafer Lot  
Y, YY = Year  
WW = Work Week  
G = Pb-Free Package

### PIN CONNECTIONS

#### D, N Packages

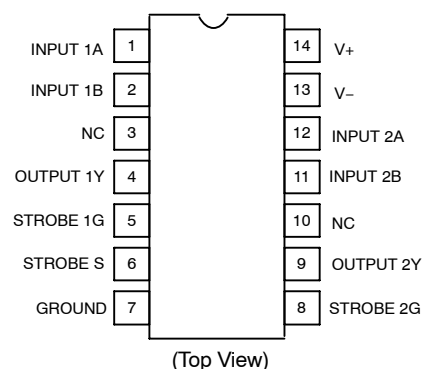

### ORDERING INFORMATION

See detailed ordering and shipping information in the package dimensions section on page 5 of this data sheet.

# NE521

## LOGIC FUNCTION TABLE

$V_{ID} (A^+, B)$	Strobe S	Strobe G	Output (Y)
$V_{ID} \leq -V_{OS}$	H	H	L
$-V_{OS} < V_{ID} < V_{OS}$	H	H	Undefined
$V_{ID} \geq V_{OS}$	H	H	H
X	L	X	H
X	X	L	H

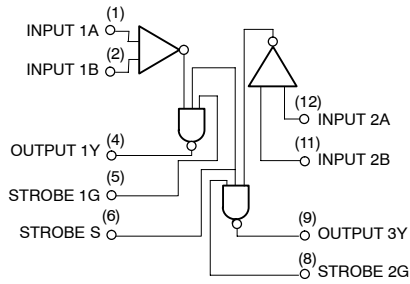

Figure 1. Block Diagram

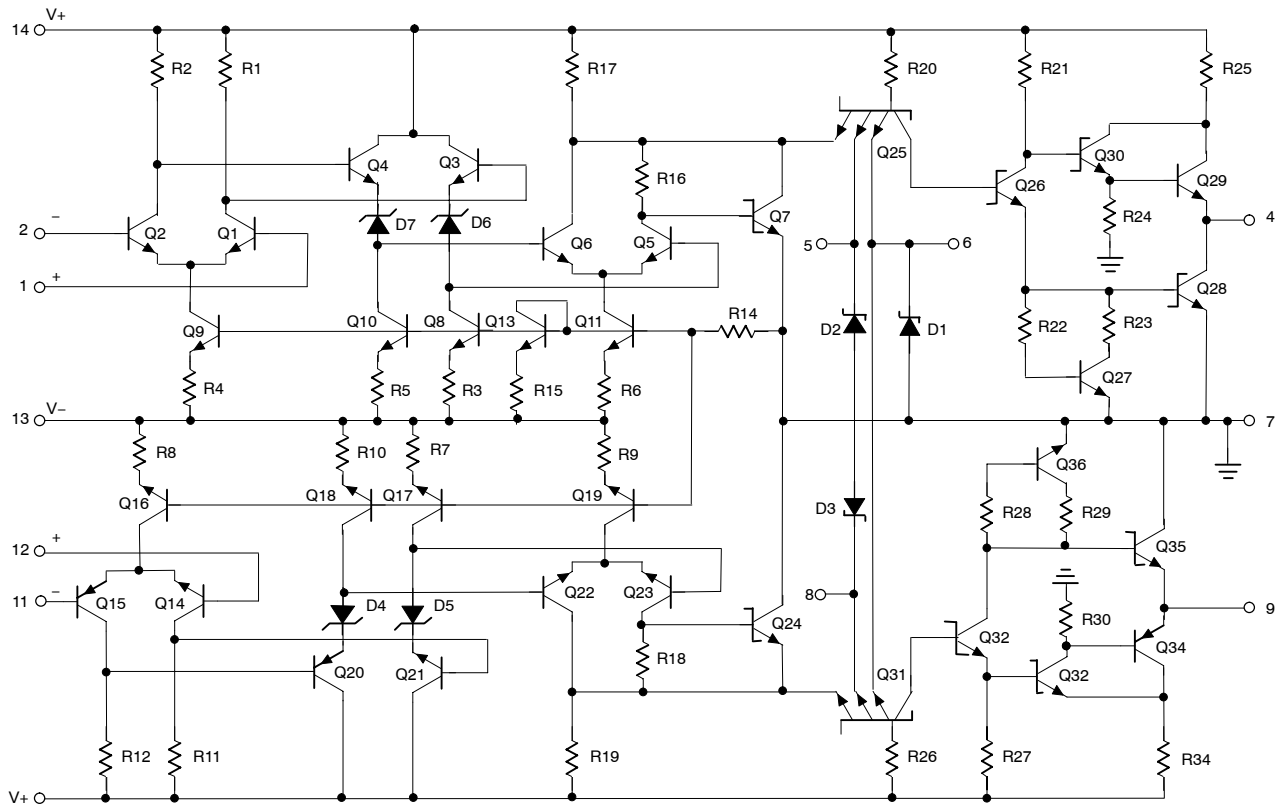

Figure 2. Equivalent Schematic

# NE521

## DC ELECTRICAL CHARACTERISTICS (V+ = +5.0 V; V- = -5.0 V, TA = 0°C to +70°C, unless otherwise noted.)

Characteristic	Test Conditions	Symbol	Limits			Unit
			Min	Typ	Max	
Input Offset Voltage At 25°C Overtemperature Range	V+ = +4.75 V; V- = -4.75 V	V <sub>OS</sub>	- -	6.0 -	7.5 10	mV
Input Bias Current At 25°C Overtemperature Range	V+ = +5.25 V; V- = -5.25 V	I <sub>BIAS</sub>	- -	7.5 -	20 40	μA
Input Offset Current At 25°C Overtemperature Range	V+ = +5.25 V; V- = -5.25 V	I <sub>OS</sub>	- -	1.0 -	5.0 12	μA
Common-Mode Voltage Range	V+ = +4.75 V; V- = -4.75 V	V <sub>CM</sub>	-3.0	-	+3.0	V
Input Current High	V+ = +5.25 V; V- = -5.25 V V <sub>IH</sub> = 2.7 V 1G or 2G Strobe Common Strobe S	I <sub>IH</sub>	- -	- -	50 100	μA
Input Current Low	V <sub>IL</sub> = 0.5 V 1G or 2G Strobe Common Strobe S	I <sub>IL</sub>	- -	- -	-2.0 -4.0	mA
Output Voltage High	V <sub>I(S)</sub> = 2.0 V V+ = +4.75 V; V- = -4.75 V; I <sub>LOAD</sub> = -1.0 mA	V <sub>OH</sub>	2.7	3.4		V
Low	V+ = +5.25 V; V- = -5.25 V; I <sub>LOAD</sub> = 20 mA	V <sub>OL</sub>			0.5	
Supply Voltage Positive Negative	-	V+ V-	4.75 -4.75	5.0 -5.0	5.25 -5.25	V
Supply Current Positive Negative	V+ = +5.25 V; V- = -5.25 V; TA = 25°C	I <sub>CC+</sub> I <sub>CC-</sub>	- -	27 -15	35 -28	mA
Short-Circuit Output Current	-	I <sub>SC</sub>	-40	-	-100	mA

## AC ELECTRICAL CHARACTERISTICS (TA = 25°C; RL = 280 Ω; CL = 15 pF, V+ = 5.0 V; V- = 5.0 V, guaranteed by characterization)

Characteristic	From Input	To Output	Symbol	Limits			Unit
				Min	Typ	Max	
<b>Large-Signal Switching Speed</b>							
Propagation Delay Low to High (Note 2)	Amp	Output	t <sub>PLH(D)</sub>	-	9.6	12	ns
High to Low (Note 2)	Amp	Output	t <sub>PHL(D)</sub>	-	8.2	9.0	
Low to High (Note 3)	Strobe	Output	t <sub>PLH(S)</sub>	-	4.8	10	
High to Low (Note 3)	Strobe	Output	t <sub>PHL(S)</sub>	-	3.9	6.0	
Max. Operating Frequency	-	-	f <sub>MAX</sub>	40	55	-	MHz

- Response time measured from 0 V point of ±100 mV<sub>P-P</sub> 10 MHz square wave to the 1.5 V point of the output.
- Response time measured from 1.5 V point of input to 1.5 V point of the output.

# NE521

## TYPICAL PERFORMANCE CHARACTERISTICS

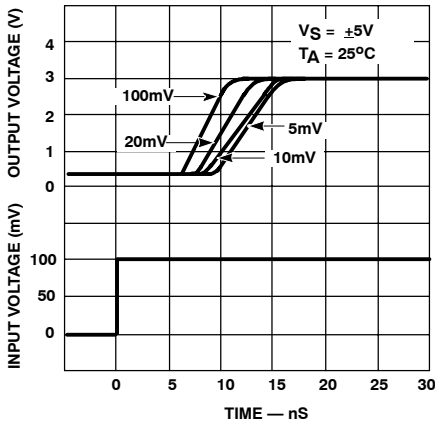

Figure 3. Response Time for Various Input Overdrives

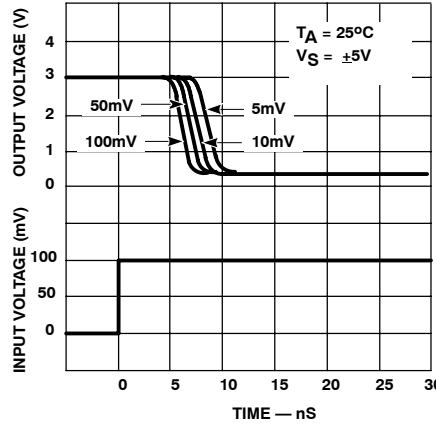

Figure 4. Response Time for Various Input Overdrives

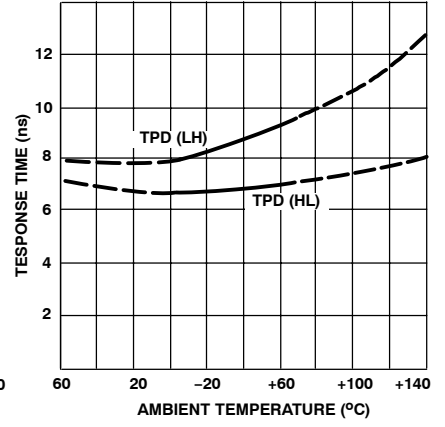

Figure 5. Response Time vs. Temperature

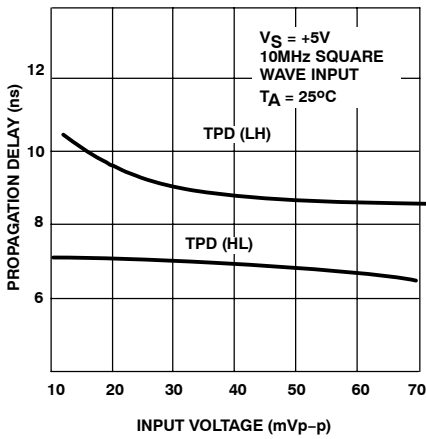

Figure 6. Propagation Delay for Various Input Voltages

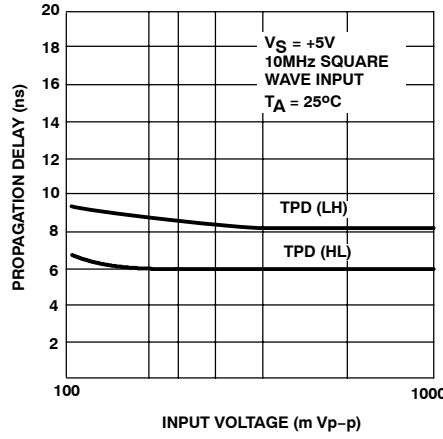

Figure 7. Propagation Delay for Various Input Voltages

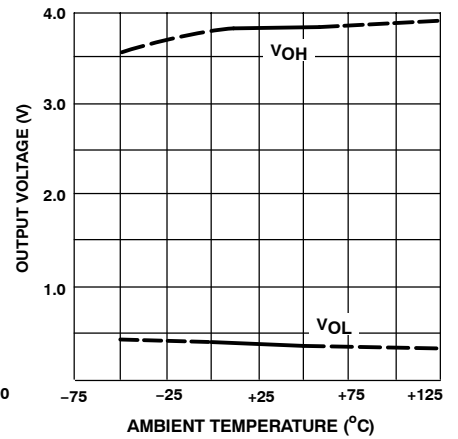

Figure 8. Output Voltage vs. Ambient Temperature

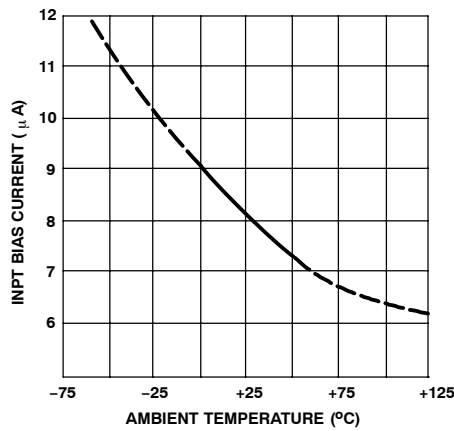

Figure 9. Input Bias Current vs. Ambient Temperature

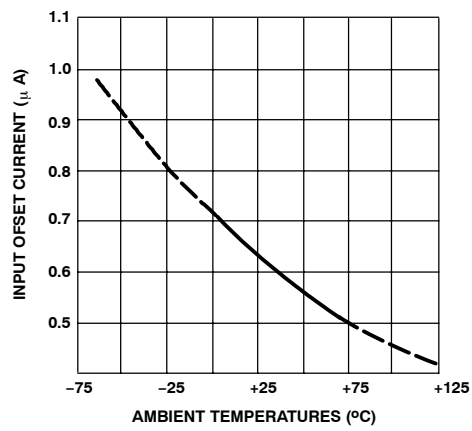

Figure 10. Input Offset Current vs. Ambient Temperature

## NE521

### ORDERING INFORMATION

Device	Temperature Range	Package	Shipping <sup>†</sup>
NE521D	0 to +70°C	SOIC-14	55 Units/Rail
NE521DG		SOIC-14 (Pb-Free)	
NE521DR2		SOIC-14	2500/Tape & Reel
NE521DR2G		SOIC-14 (Pb-Free)	
NE521N		PDIP-14	25 Units/Rail
NE521NG		PDIP-14 (Pb-Free)	

<sup>†</sup>For information on tape and reel specifications, including part orientation and tape sizes, please refer to our Tape and Reel Packaging Specification Brochure, BRD8011/D.

# NE521

## PACKAGE DIMENSIONS

SOIC-14  
CASE 751A-03  
ISSUE H

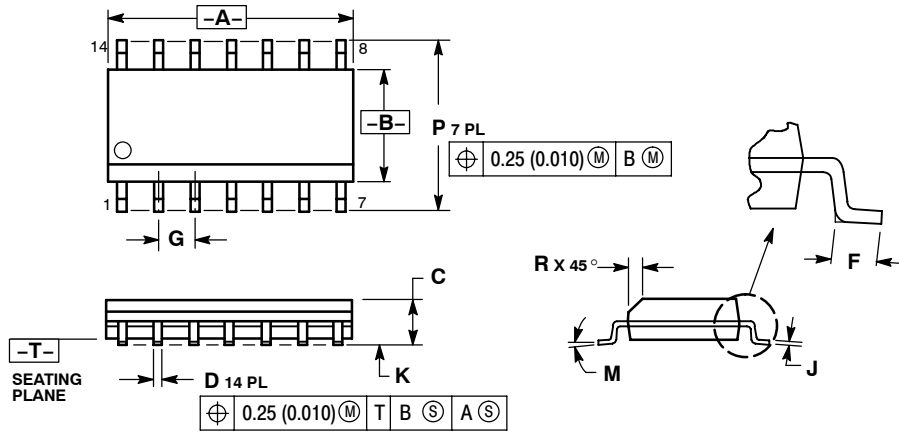

### NOTES:

1. DIMENSIONING AND TOLERANCING PER ANSI Y14.5M, 1982.
2. CONTROLLING DIMENSION: MILLIMETER.
3. DIMENSIONS A AND B DO NOT INCLUDE MOLD PROTRUSION.
4. MAXIMUM MOLD PROTRUSION 0.15 (0.006) PER SIDE.
5. DIMENSION D DOES NOT INCLUDE DAMBAR PROTRUSION. ALLOWABLE DAMBAR PROTRUSION SHALL BE 0.127 (0.005) TOTAL IN EXCESS OF THE D DIMENSION AT MAXIMUM MATERIAL CONDITION.

DIM	MILLIMETERS		INCHES	
	MIN	MAX	MIN	MAX
A	8.55	8.75	0.337	0.344
B	3.80	4.00	0.150	0.157
C	1.35	1.75	0.054	0.068
D	0.35	0.49	0.014	0.019
F	0.40	1.25	0.016	0.049
G	1.27	BSC	0.050	BSC
J	0.19	0.25	0.008	0.009
K	0.10	0.25	0.004	0.009
M	0°	7°	0°	7°
P	5.80	6.20	0.228	0.244
R	0.25	0.50	0.010	0.019

### SOLDERING FOOTPRINT\*

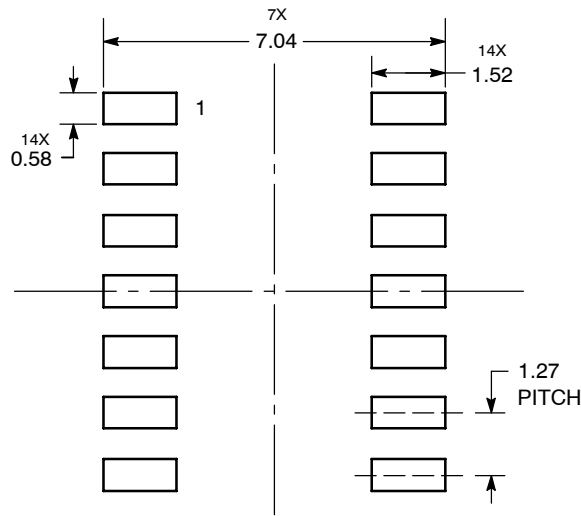

DIMENSIONS: MILLIMETERS

\*For additional information on our Pb-Free strategy and soldering details, please download the ON Semiconductor Soldering and Mounting Techniques Reference Manual, SOLDERRM/D.

# NE521

## PACKAGE DIMENSIONS

PDIP-14  
CASE 646-06  
ISSUE P

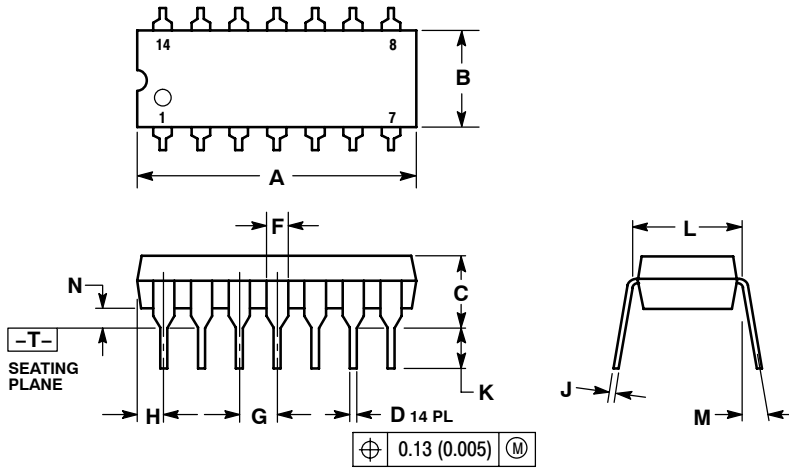

### NOTES:

1. DIMENSIONING AND TOLERANCING PER ANSI Y14.5M, 1982.
2. CONTROLLING DIMENSION: INCH.
3. DIMENSION L TO CENTER OF LEADS WHEN FORMED PARALLEL.
4. DIMENSION B DOES NOT INCLUDE MOLD FLASH.
5. ROUNDED CORNERS OPTIONAL.

DIM	INCHES		MILLIMETERS	
	MIN	MAX	MIN	MAX
A	0.715	0.770	18.16	19.56
B	0.240	0.260	6.10	6.60
C	0.145	0.185	3.69	4.69
D	0.015	0.021	0.38	0.53
F	0.040	0.070	1.02	1.78
G	0.100 BSC		2.54 BSC	
H	0.052	0.095	1.32	2.41
J	0.008	0.015	0.20	0.38
K	0.115	0.135	2.92	3.43
L	0.290	0.310	7.37	7.87
M	---	10°	---	10°
N	0.015	0.039	0.38	1.01

**ON Semiconductor** and  are registered trademarks of Semiconductor Components Industries, LLC (SCILLC). SCILLC reserves the right to make changes without further notice to any products herein. SCILLC makes no warranty, representation or guarantee regarding the suitability of its products for any particular purpose, nor does SCILLC assume any liability arising out of the application or use of any product or circuit, and specifically disclaims any and all liability, including without limitation special, consequential or incidental damages. "Typical" parameters which may be provided in SCILLC data sheets and/or specifications can and do vary in different applications and actual performance may vary over time. All operating parameters, including "Typicals" must be validated for each customer application by customer's technical experts. SCILLC does not convey any license under its patent rights nor the rights of others. SCILLC products are not designed, intended, or authorized for use as components in systems intended for surgical implant into the body, or other applications intended to support or sustain life, or for any other application in which the failure of the SCILLC product could create a situation where personal injury or death may occur. Should Buyer purchase or use SCILLC products for any such unintended or unauthorized application, Buyer shall indemnify and hold SCILLC and its officers, employees, subsidiaries, affiliates, and distributors harmless against all claims, costs, damages, and expenses, and reasonable attorney fees arising out of, directly or indirectly, any claim of personal injury or death associated with such unintended or unauthorized use, even if such claim alleges that SCILLC was negligent regarding the design or manufacture of the part. SCILLC is an Equal Opportunity/Affirmative Action Employer. This literature is subject to all applicable copyright laws and is not for resale in any manner.

### PUBLICATION ORDERING INFORMATION

#### LITERATURE FULFILLMENT:

Literature Distribution Center for ON Semiconductor  
P.O. Box 5163, Denver, Colorado 80217 USA  
Phone: 303-675-2175 or 800-344-3860 Toll Free USA/Canada  
Fax: 303-675-2176 or 800-344-3867 Toll Free USA/Canada  
Email: orderlit@onsemi.com

**N. American Technical Support:** 800-282-9855 Toll Free  
USA/Canada

**Europe, Middle East and Africa Technical Support:**  
Phone: 421 33 790 2910  
**Japan Customer Focus Center**  
Phone: 81-3-5773-3850

**ON Semiconductor Website:** [www.onsemi.com](http://www.onsemi.com)

**Order Literature:** <http://www.onsemi.com/orderlit>

For additional information, please contact your local  
Sales Representative