

**ISP815X, ISP825X, ISP845X**  
**ISP815, ISP825, ISP845**



**HIGH DENSITY MOUNTING  
 PHOTODARLINGTON OPTICALLY  
 COUPLED ISOLATORS**

**APPROVALS**

- UL recognised, File No. E91231

**'X' SPECIFICATION APPROVALS**

- VDE 0884 approval pending
- Certified to EN60950 by the following Test Bodies :-  
 Nemko - Certificate No. P96102022  
 Fimko - Registration No. 192313-01..25  
 Semko - Reference No. 9639052 01  
 Demko - Reference No. 305969

**DESCRIPTION**

The ISP815, ISP825, ISP845 series of optically coupled isolators consist of infrared light emitting diodes and NPN silicon photodarlington transistors in space efficient dual in line plastic packages.

**FEATURES**

- Options :-  
 10mm lead spread - add G after part no.  
 Surface mount - add SM after part no.  
 Tape&reel - add SMT&R after part no.
- High Current Transfer Ratio (600%min)
- High Isolation Voltage (5.3kV<sub>RMS</sub>, 7.5kV<sub>PK</sub>)
- All electrical parameters 100% tested
- Custom electrical selections available

**APPLICATIONS**

- Computer terminals
- Industrial systems controllers
- Measuring instruments
- Signal transmission between systems of different potentials and impedances

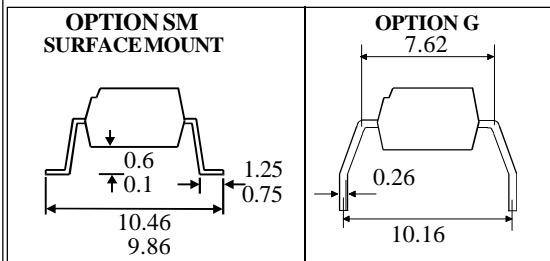

**ISP815X  
ISP815**

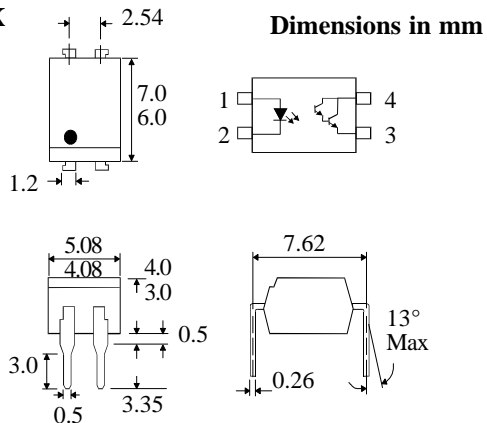

**ISP825X  
ISP825**

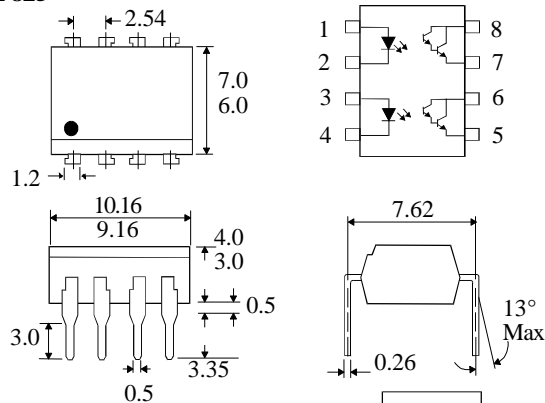

**ISP845X  
ISP845**

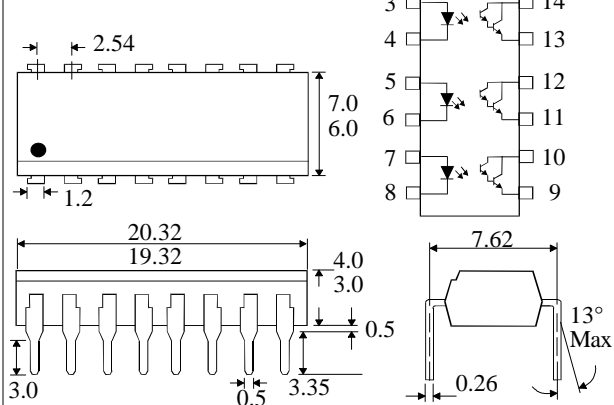

**ISOCOM COMPONENTS LTD**  
 Unit 25B, Park View Road West,  
 Park View Industrial Estate, Brenda Road  
 Hartlepool, Cleveland, TS25 1YD  
 Tel: (01429) 863609 Fax :(01429) 863581

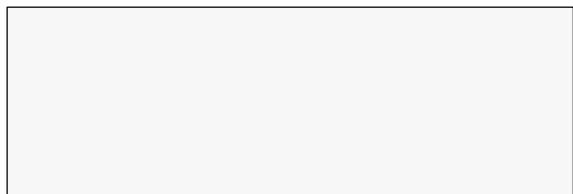

**ABSOLUTE MAXIMUM RATINGS**  
(25°C unless otherwise specified)

Storage Temperature \_\_\_\_\_ -55°C to + 125°C  
 Operating Temperature \_\_\_\_\_ -55°C to + 100°C  
 Lead Soldering Temperature  
 (1/16 inch (1.6mm) from case for 10 secs) 260°C

**INPUT DIODE**

Forward Current \_\_\_\_\_ 50mA  
 Reverse Voltage \_\_\_\_\_ 6V  
 Power Dissipation \_\_\_\_\_ 70mW

**OUTPUT TRANSISTOR**

Collector-emitter Voltage  $BV_{CEO}$  \_\_\_\_\_ 35V  
 Emitter-collector Voltage  $BV_{ECO}$  \_\_\_\_\_ 6V  
 Power Dissipation \_\_\_\_\_ 150mW

**POWER DISSIPATION**

Total Power Dissipation \_\_\_\_\_ 200mW  
 (derate linearly 2.67mW/°C above 25°C)

**ELECTRICAL CHARACTERISTICS (  $T_A = 25^\circ\text{C}$  Unless otherwise noted )**

PARAMETER		MIN	TYP	MAX	UNITS	TEST CONDITION
Input	Forward Voltage ( $V_F$ )		1.2	1.4	V	$I_F = 20\text{mA}$
	Reverse Voltage ( $V_R$ )	6			V	$I_R = 10\mu\text{A}$
	Reverse Current ( $I_R$ )			10	$\mu\text{A}$	$V_R = 6\text{V}$
Output	Collector-emitter Breakdown ( $BV_{CEO}$ ) ( Note 2 )	35			V	$I_C = 1\text{mA}$
	Emitter-collector Breakdown ( $BV_{ECO}$ )	6			V	$I_E = 100\mu\text{A}$
	Collector-emitter Dark Current ( $I_{CEO}$ )			100	nA	$V_{CE} = 20\text{V}$
Coupled	Current Transfer Ratio (CTR) (Note 2)	600		7500	%	$1\text{mA } I_F, 2\text{V } V_{CE}$
	Collector-emitter Saturation Voltage $V_{CE(SAT)}$			1.0	V	$20\text{mA } I_F, 5\text{mA } I_C$
	Input to Output Isolation Voltage $V_{ISO}$	5300 7500			$V_{RMS}$ $V_{PK}$	See note 1 See note 1
	Input-output Isolation Resistance $R_{ISO}$	$5 \times 10^{10}$			$\Omega$	$V_{IO} = 500\text{V}$ (note 1)
	Output Rise Time tr Output Fall Time tf		60 53	300 250	$\mu\text{s}$ $\mu\text{s}$	$V_{CE} = 2\text{V}$ , $I_C = 10\text{mA}, R_L = 100\Omega$

Note 1 Measured with input leads shorted together and output leads shorted together.

Note 2 Special Selections are available on request. Please consult the factory.

**Collector Power Dissipation vs. Ambient Temperature**

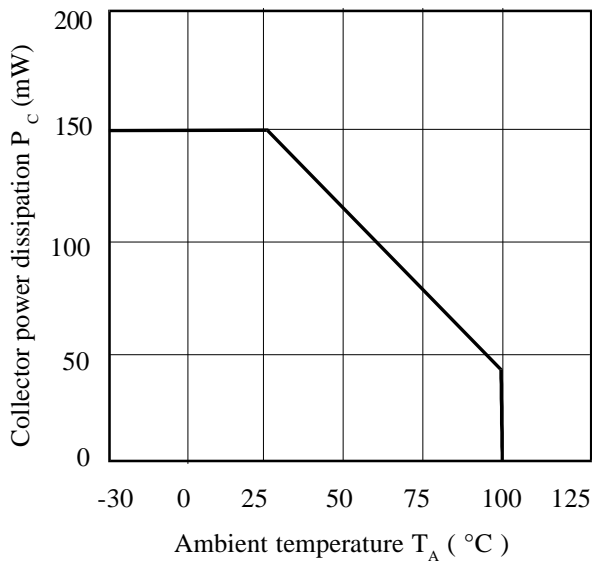

**Collector-emitter Saturation Voltage vs. Forward Current**

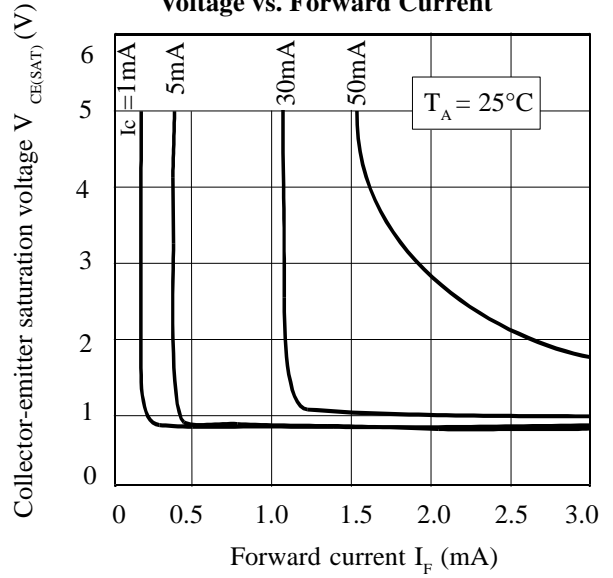

**Forward Current vs. Ambient Temperature**

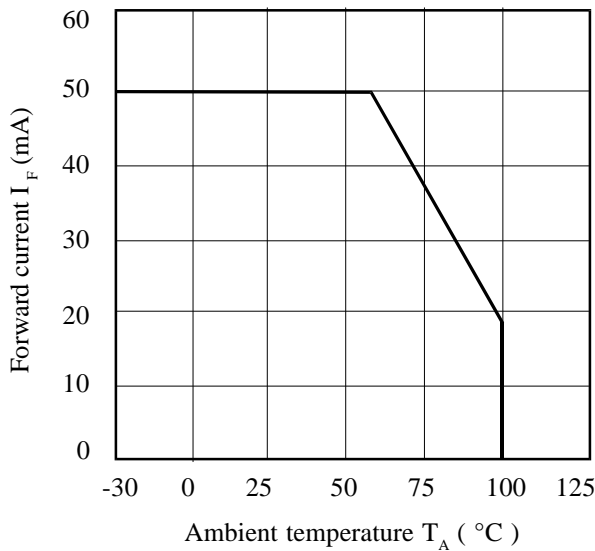

**Collector Current vs. Collector-emitter Voltage**

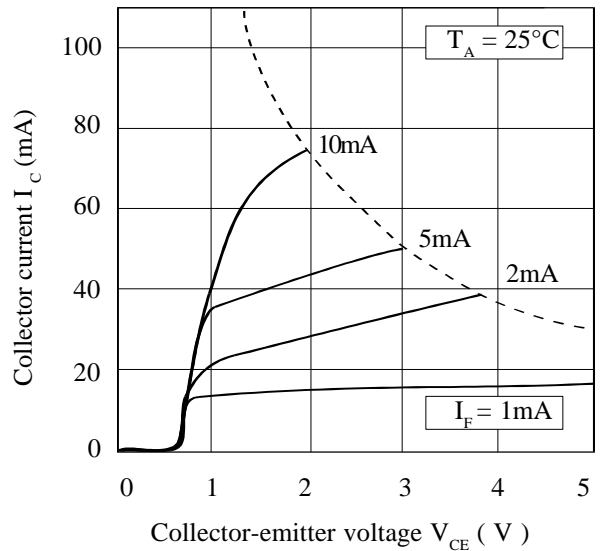

**Collector-emitter Saturation Voltage vs. Ambient Temperature**

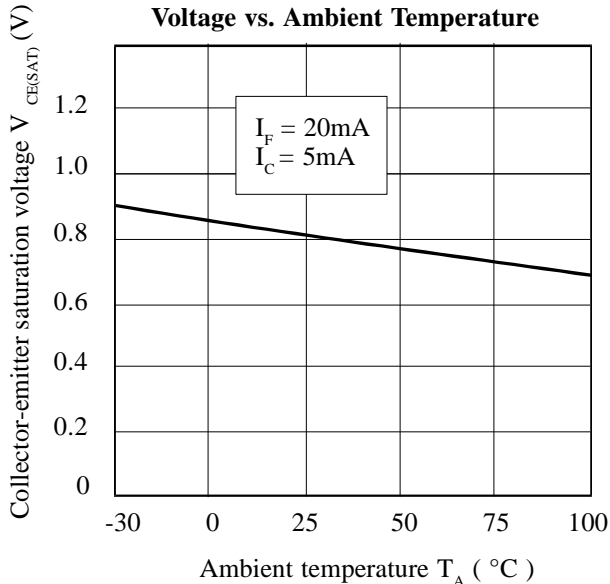

**Relative Current Transfer Ratio vs. Ambient Temperature**

