

FEATURES

- **Ultralow Quiescent Current: 8.5 μ A Max**
- **Reference Output Drives 0.01 μ F Capacitor**
- **Adjustable Hysteresis (LTC1444/LTC1445)**
- **Wide Supply Range**
 Single: 2V to 11V
 Dual: \pm 1V to \pm 5.5V
- **Input Voltage Range Includes the Negative Supply**
- **TTL/CMOS Compatible Outputs**
- **Propagation Delay: 12 μ s (Typ) (10mV Overdrive)**
- **No Crowbar Current**
- **40mA Continuous Source Current**
- **Pin Compatible Upgrades for MAX924 (LTC1443)**
- **Low Profile (5mm \times 4mm \times 0.8mm) DFN Package**

APPLICATIONS

- Battery-Powered System Monitoring
- Threshold Detectors
- Window Comparators
- Oscillator Circuits

LT, LT, LTC, LTM, Linear Technology and the Linear logo are registered trademarks of Linear Technology Corporation. All other trademarks are the property of their respective owners.

DESCRIPTION

The LTC[®]1443/LTC1444/LTC1445 are ultralow power quad comparators with a built-in reference. The comparators feature less than 8.5 μ A supply current over temperature, an internal reference (1.182V \pm 1% for LTC1443 or 1.221V \pm 1% for LTC1444/LTC1445), programmable hysteresis (LTC1444/LTC1445) and TTL/CMOS output (LTC1443/LTC1445) that sinks and sources current (open-drain output for LTC1444). The reference output can drive a bypass capacitor of up to 0.01 μ F without oscillation.

The comparators operate from a single 2V to 11V supply or a dual \pm 1V to \pm 5.5V supply (LTC1443). Comparator hysteresis is easily programmable using two resistors and the HYST pin (LTC1444/LTC1445). Each comparator's input operates from the negative supply to within 1.3V of the positive supply. The LTC1443/LTC1445 comparator output stage can continuously source up to 40mA. By eliminating the cross-conducting current that normally happens when the comparator changes logic states, power supply glitches are eliminated.

The LTC1443/LTC1444/LTC1445 are available in the 16-pin SO, PDIP and DFN packages.

TYPICAL APPLICATION

Reference Settling Test Circuit

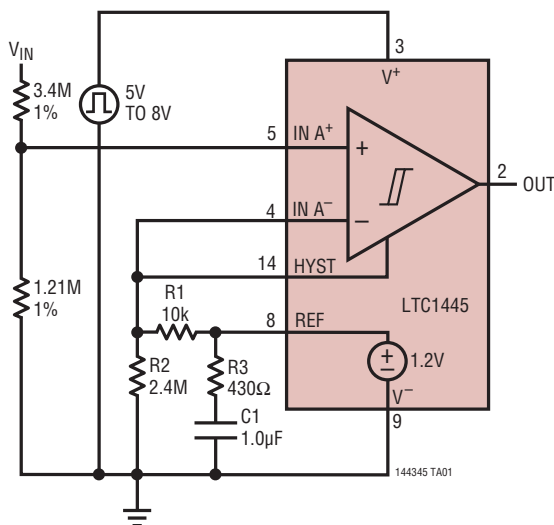

Reference Settling

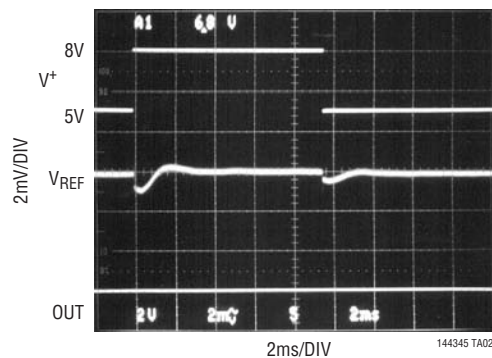

LTC1443/LTC1444/LTC1445

ABSOLUTE MAXIMUM RATINGS (Note 1)

Voltage:

V⁺ to V⁻, V⁺ to GND, GND to V⁻ 12V to -0.3V
 IN⁺, IN⁻, HYST (V⁺ + 0.3V) to (V⁻ - 0.3V)
 REF (V⁺ + 0.3V) to (V⁻ - 0.3V)
 OUT (LTC1443) (V⁺ + 0.3V) to (GND - 0.3V)
 OUT
 (LTC1444/LTC1445) (V⁺ + 0.3V) to (V⁻ - 0.3V)

Current:

IN⁺, IN⁻, HYST 20mA
 REF 20mA
 OUT 50mA

OUT Short-Circuit Duration (V⁺ ≤ 5.5V) Continuous
 Power Dissipation 500mW
 Operating Temperature Range
 Commercial 0°C to 70°C
 Industrial -40°C to 85°C
 Storage Temperature Range
 PDIP, SO -65°C to 150°C
 DFN -65°C to 150°C
 Lead Temperature Range (Soldering, 10 sec)
 PDIP, SO 300°C

PIN CONFIGURATION

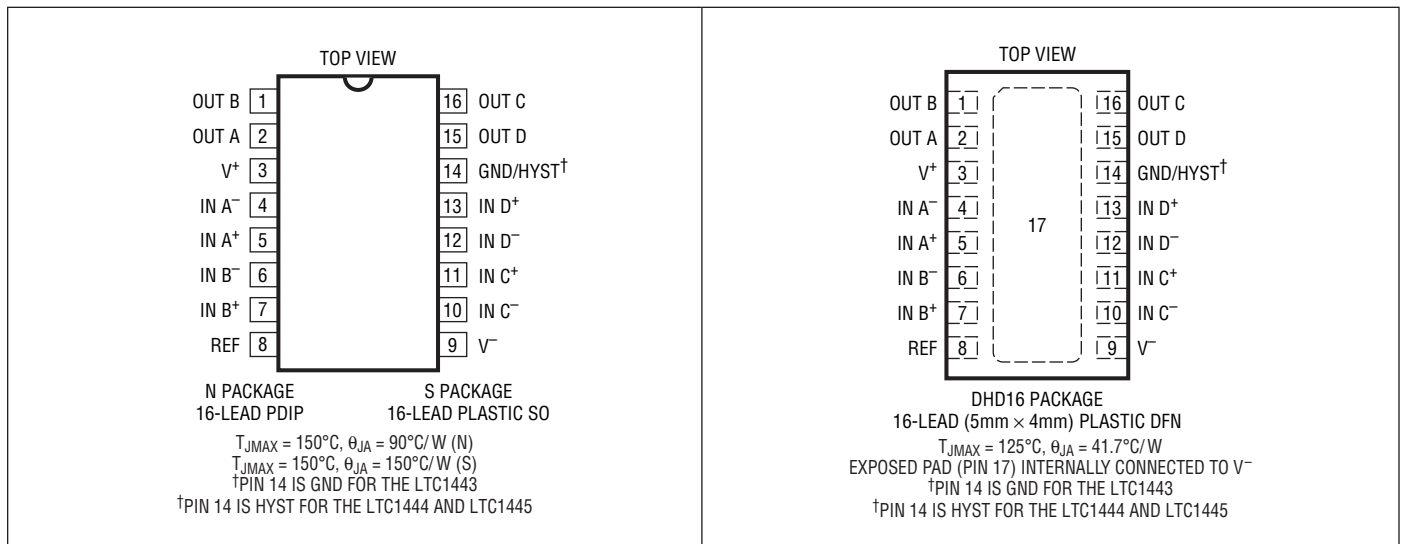

ORDER INFORMATION

| LEAD FREE FINISH | TAPE AND REEL | PART MARKING* | PACKAGE DESCRIPTION | SPECIFIED TEMPERATURE RANGE |
|------------------|-------------------|---------------|---------------------------------|-----------------------------|
| LTC1443CN#PBF | LTC1443CN#TRPBF | LTC1443CN | 16-Lead PDIP | 0°C to 70°C |
| LTC1443CS#PBF | LTC1443CS#TRPBF | LTC1443CS | 16-Lead Plastic SO | 0°C to 70°C |
| LTC1443IN#PBF | LTC1443IN#TRPBF | LTC1443IN | 16-Lead PDIP | -40°C to 85°C |
| LTC1443IS#PBF | LTC1443IS#TRPBF | LTC1443IS | 16-Lead Plastic SO | -40°C to 85°C |
| LTC1444CN#PBF | LTC1444CN#TRPBF | LTC1444CN | 16-Lead PDIP | 0°C to 70°C |
| LTC1444CS#PBF | LTC1444CS#TRPBF | LTC1444CS | 16-Lead Plastic SO | 0°C to 70°C |
| LTC1444IN#PBF | LTC1444IN#TRPBF | LTC1444IN | 16-Lead PDIP | -40°C to 85°C |
| LTC1444IS#PBF | LTC1444IS#TRPBF | LTC1444IS | 16-Lead Plastic SO | -40°C to 85°C |
| LTC1445CN#PBF | LTC1445CN#TRPBF | LTC1445CN | 16-Lead PDIP | 0°C to 70°C |
| LTC1445CS#PBF | LTC1445CS#TRPBF | LTC1445CS | 16-Lead Plastic SO | 0°C to 70°C |
| LTC1445IN#PBF | LTC1445IN#TRPBF | LTC1445IN | 16-Lead PDIP | -40°C to 85°C |
| LTC1445IS#PBF | LTC1445IS#TRPBF | LTC1445IS | 16-Lead Plastic SO | -40°C to 85°C |
| LTC1443CDHD#PBF | LTC1443CDHD#TRPBF | 1443 | 16-Lead (5mm × 4mm) Plastic DFN | 0°C to 70°C |
| LTC1443IDHD#PBF | LTC1443IDHD#TRPBF | 1443 | 16-Lead (5mm × 4mm) Plastic DFN | -40°C to 85°C |
| LTC1444CDHD#PBF | LTC1444CDHD#TRPBF | 1444 | 16-Lead (5mm × 4mm) Plastic DFN | 0°C to 70°C |
| LTC1444IDHD#PBF | LTC1444IDHD#TRPBF | 1444 | 16-Lead (5mm × 4mm) Plastic DFN | -40°C to 85°C |
| LTC1445CDHD#PBF | LTC1445CDHD#TRPBF | 1445 | 16-Lead (5mm × 4mm) Plastic DFN | 0°C to 70°C |
| LTC1445IDHD#PBF | LTC1445IDHD#TRPBF | 1445 | 16-Lead (5mm × 4mm) Plastic DFN | -40°C to 85°C |

Consult LTC Marketing for parts specified with wider operating temperature ranges. *The temperature grade is identified by a label on the shipping container. Consult LTC Marketing for information on nonstandard lead based finish parts.

For more information on lead free part marking, go to: <http://www.linear.com/leadfree/>

For more information on tape and reel specifications, go to: <http://www.linear.com/tapeandreel/>

ELECTRICAL CHARACTERISTICS

The ● denotes the specifications which apply over the full operating temperature range, otherwise specifications are at $T_A = 25^\circ\text{C}$. $V^+ = 5\text{V}$, $V^- = \text{GND} = 0\text{V}$, unless otherwise noted.

| SYMBOL | PARAMETER | CONDITIONS | MIN | TYP | MAX | UNITS |
|---------------------|---|---|---------|----------------------------|---------------------|---------------------|
| Power Supply | | | | | | |
| V^+ | Supply Voltage Range | | ● 2.0 | | 11.0 | V |
| I_{CC} | Supply Current | $I_{IN^+} = I_{IN^-} = 80\text{mV}$ $\text{HYST} = \text{REF}$ (LTC1444/LTC1445) | ● | 5.5 | 8.5 | μA |
| Comparator | | | | | | |
| V_{OS} | Comparator Input Offset Voltage | $V_{CM} = 2.5\text{V}$ | ● | ± 3.0 | ± 10.0 | mV |
| I_{IN} | Input Leakage Current (I_{IN^+} , I_{IN^-}) | $V_{IN^+} = V_{IN^-} = 2.5\text{V}$ | ● | ± 0.01 | ± 1.0 | nA |
| | Input Leakage Current (HYST) | LTC1444/LTC1445 | ● | ± 0.02 | ± 1.0 | nA |
| V_{CM} | Comparator Input Common Mode Range | | ● V^- | | $V^+ - 1.3\text{V}$ | V |
| CMRR | Common Mode Rejection Ratio | V^- to ($V^+ - 1.3\text{V}$) | | 0.1 | 1.0 | mV/V |
| PSRR | Power Supply Rejection Ratio | $V^+ = 2\text{V}$ to 11V | | 0.1 | 1.0 | mV/V |
| Noise | Voltage Noise | 100Hz to 100kHz | | 20 | | μV_{RMS} |
| V_{HYST} | Hysteresis Input Voltage Range | LTC1444, LTC1445 | ● | $\text{REF} - 50\text{mV}$ | REF | V |
| t_{PD} | Propagation Delay | Overdrive = 10mV, $C_{OUT} = 100\text{pF}$ | | 12 | | μs |
| | | Overdrive = 100mV, $C_{OUT} = 100\text{pF}$ | | 4 | | μs |

LTC1443/LTC1444/LTC1445

ELECTRICAL CHARACTERISTICS The ● denotes the specifications which apply over the full operating temperature range, otherwise specifications are at $T_A = 25^\circ\text{C}$. $V^+ = 5\text{V}$, $V^- = \text{GND} = 0\text{V}$, unless otherwise noted.

| SYMBOL | PARAMETER | CONDITIONS | | MIN | TYP | MAX | UNITS | |
|------------------|---------------------------------|--|--------------|-----------------------------------|-------|-------|---------------------|---|
| V_{OH} | Output High Voltage | $I_O = -15\text{mA}$; LTC1443/LTC1445 | ● | $V^+ - 0.4\text{V}$ | | | V | |
| V_{OL} | Output Low Voltage | $I_O = 1.8\text{mA}$; LTC1443 $I_O = 1.8\text{mA}$; LTC1444/LTC1445 | ● ● | GND + 0.4V $V^- + 0.4\text{V}$ | | | V V | |
| Reference | | | | | | | | |
| V_{REF} | Reference Voltage | No Load, LTC1443 | C Temp Range | ● | 1.170 | 1.182 | 1.194 | V |
| | | | I Temp Range | ● | 1.164 | | 1.200 | V |
| | | No Load, LTC1444/ LTC1445 | C Temp Range | ● | 1.209 | 1.221 | 1.233 | V |
| | | | I Temp Range | ● | 1.203 | | 1.239 | V |
| I_{SOURCE} | Reference Output Source Current | $\Delta V_{REF} \leq 1\text{mV}$ | ● | 100 | 200 | | μA | |
| I_{SINK} | Reference Output Sink Current | $\Delta V_{REF} \leq 2.5\text{mV}$ | | 10 | 15 | | μA | |
| | | $\Delta V_{REF} \leq 5\text{mV}$ | ● | 10 | 15 | | μA | |
| Noise | Voltage Noise | 100Hz to 100kHz | | | 100 | | μV_{RMS} | |

The ● denotes the specifications which apply over the full operating temperature range, otherwise specifications are at $T_A = 25^\circ\text{C}$. $V^+ = 3\text{V}$, $V^- = \text{GND} = 0\text{V}$, unless otherwise noted.

| SYMBOL | PARAMETER | CONDITIONS | | MIN | TYP | MAX | UNITS | |
|---------------------|---|--|--------------|---------------------|------------|---------------------|---------------------|---|
| Power Supply | | | | | | | | |
| V^+ | Supply Voltage Range | | ● | 2.0 | | 11.0 | V | |
| I_{CC} | Supply Current | $I_{IN^+} = I_{IN^-} = 80\text{mV}$, HYST = REF | ● | | 5 | 8 | μA | |
| Comparator | | | | | | | | |
| V_{OS} | Comparator Input Offset Voltage | $V_{CM} = 1.5\text{V}$ | ● | | ± 3.0 | ± 10.0 | mV | |
| I_{IN} | Input Leakage Current (I_{IN^+} , I_{IN^-}) | $V_{IN^+} = V_{IN^-} = 1.5\text{V}$ | ● | | ± 0.01 | ± 1.0 | nA | |
| | Input Leakage Current (HYST) | LTC1444/LTC1445 | ● | | ± 0.02 | ± 1.0 | nA | |
| V_{CM} | Comparator Input Common Mode Range | | ● | V^- | | $V^+ - 1.3\text{V}$ | V | |
| CMRR | Common Mode Rejection Ratio | V^- to $(V^+ - 1.3\text{V})$ | | | 0.1 | 1.0 | mV/V | |
| PSRR | Power Supply Rejection Ratio | $V^+ = 2\text{V}$ to 11V | | | 0.1 | 1.0 | mV/V | |
| Noise | Voltage Noise | 100Hz to 100kHz | | | 100 | | μV_{RMS} | |
| V_{HYST} | Hysteresis Input Voltage Range | LTC1444, LTC1445 | ● | REF - 50mV | | REF | V | |
| t_{PD} | Propagation Delay | Overdrive = 10mV, $C_{OUT} = 100\text{pF}$ | | | 14 | | μs | |
| | | Overdrive = 100mV, $C_{OUT} = 100\text{pF}$ | | | 5 | | μs | |
| V_{OH} | Output High Voltage | $I_O = -10\text{mA}$; LTC1443/LTC1445 | ● | $V^+ - 0.4\text{V}$ | | | V | |
| V_{OL} | Output Low Voltage | $I_O = 0.8\text{mA}$; LTC1443 | ● | GND + 0.4V | | | V | |
| | | $I_O = 0.8\text{mA}$; LTC1444/LTC1445 | ● | $V^- + 0.4\text{V}$ | | | V | |
| Reference | | | | | | | | |
| V_{REF} | Reference Voltage | No Load, LTC1443 | C Temp Range | ● | 1.170 | 1.182 | 1.194 | V |
| | | | I Temp Range | ● | 1.164 | | 1.200 | V |
| | | No Load, LTC1444/ LTC1445 | C Temp Range | ● | 1.209 | 1.221 | 1.233 | V |
| | | | I Temp Range | ● | 1.203 | | 1.239 | V |
| I_{SOURCE} | Reference Output Source Current | $\Delta V_{REF} \leq 1\text{mV}$ | ● | 60 | 120 | | μA | |
| I_{SINK} | Reference Output Sink Current | $\Delta V_{REF} \leq 2.5\text{mV}$ | | 10 | 15 | | μA | |
| | | $\Delta V_{REF} \leq 5\text{mV}$ | ● | 10 | 15 | | μA | |
| Noise | Noise Voltage | 100Hz to 100kHz | | | 100 | | μV_{RMS} | |

Note 1: Stresses beyond those listed under Absolute Maximum Ratings may cause permanent damage to the device. Exposure to any Absolute

Maximum Rating condition for extended periods may affect device reliability and lifetime.

TYPICAL PERFORMANCE CHARACTERISTICS

**LTC1444/LTC1445
Hysteresis Control**

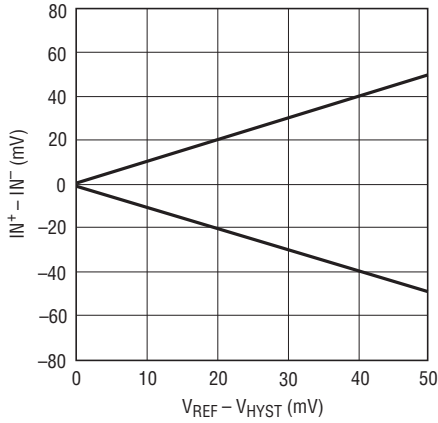

144345 G01

Supply Current vs Supply Voltage

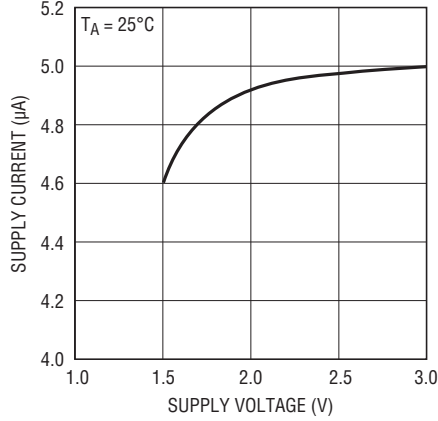

144345 G02

Supply Current vs Temperature

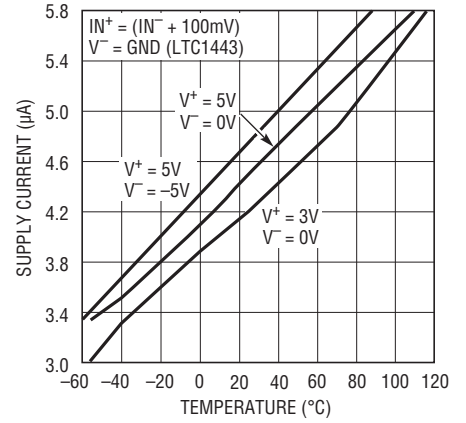

144345 G03

**LTC1444/LTC1445 Reference
Voltage vs Temperature**

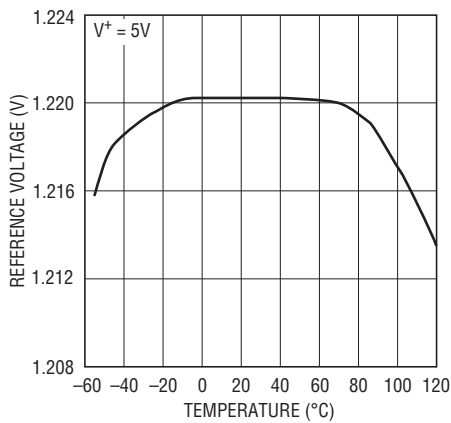

144345 G04

**LTC1443 Reference Voltage
vs Temperature**

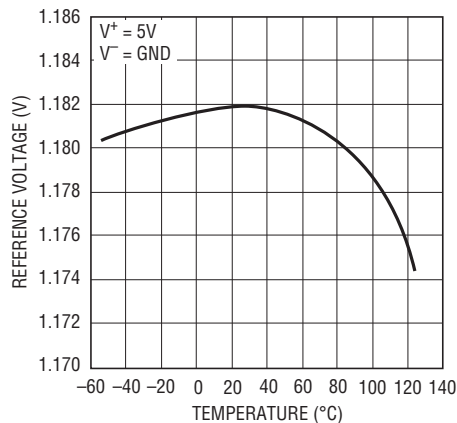

144345 G05

**LTC1443 Reference Output
Voltage vs Output Load Current**

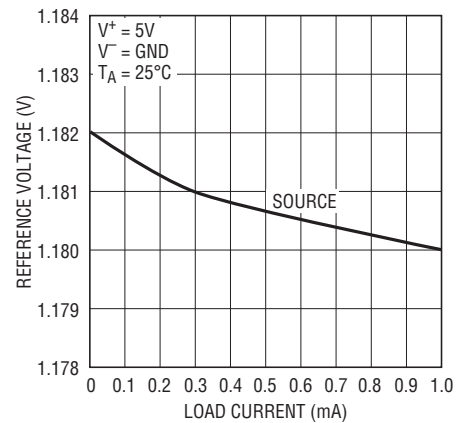

144345 G06

**LTC1443 Reference Output
Voltage vs Output Load Current**

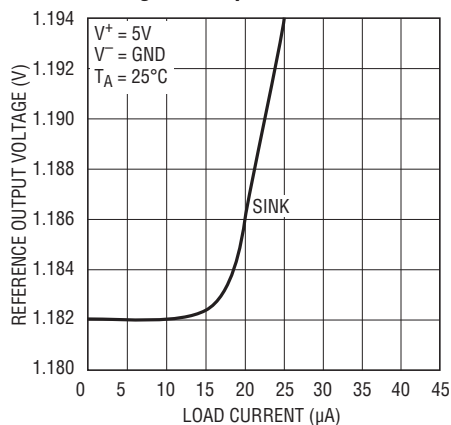

144345 G07

**Comparator Output Voltage High
vs Load Current**

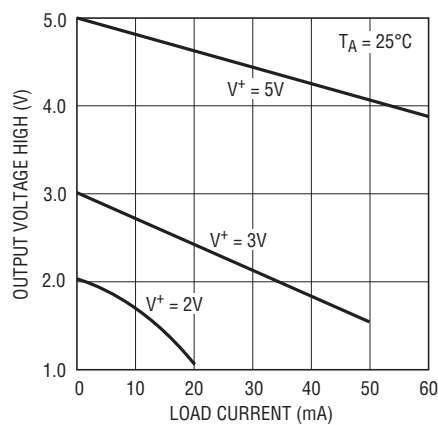

144345 G08

**Comparator Output Voltage Low
vs Load Current**

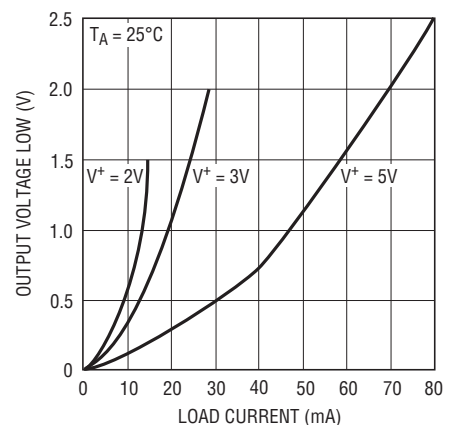

144345 G09

TYPICAL PERFORMANCE CHARACTERISTICS

Comparator Response Time vs Input Overdrive

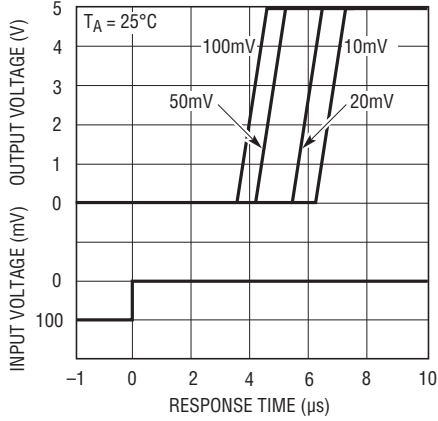

144345 G10

Comparator Response Time vs Input Overdrive

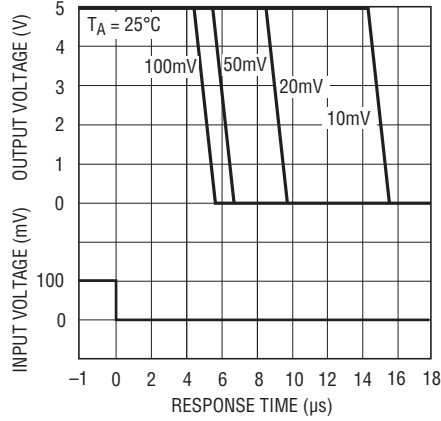

144345 G11

Comparator Short-Circuit Sink Current vs Supply Voltage

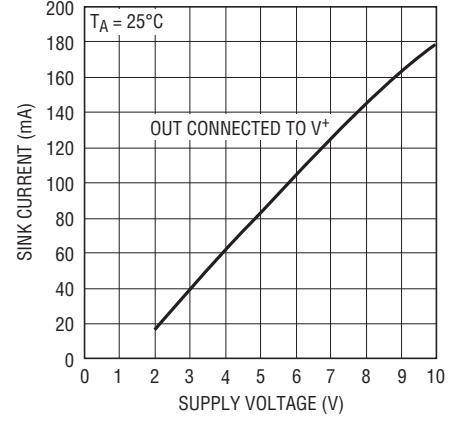

144345 G12

Comparator Short-Circuit Source Current vs Supply Voltage

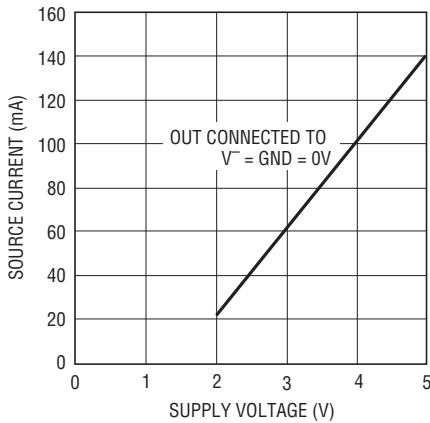

144345 G13

Comparator Response Time vs Load Capacitance

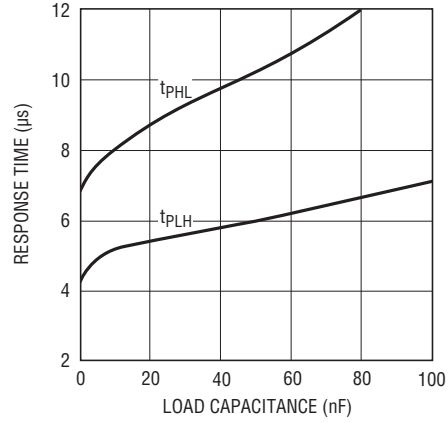

144345 G14

Supply Current vs Comparator Input Frequency

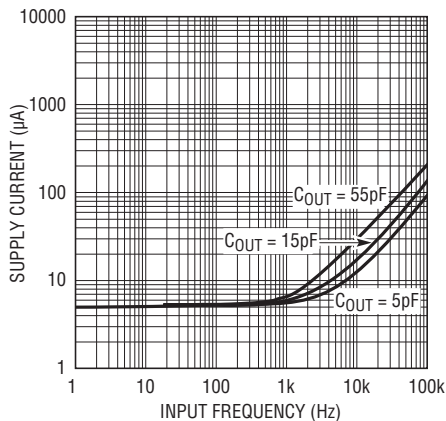

144345 G15

Comparator Response Time at Low Supply Voltage

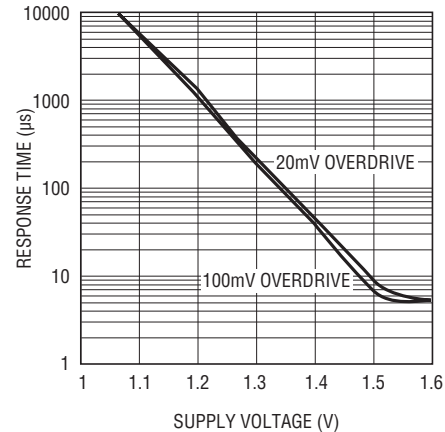

144345 G16

PIN FUNCTIONS

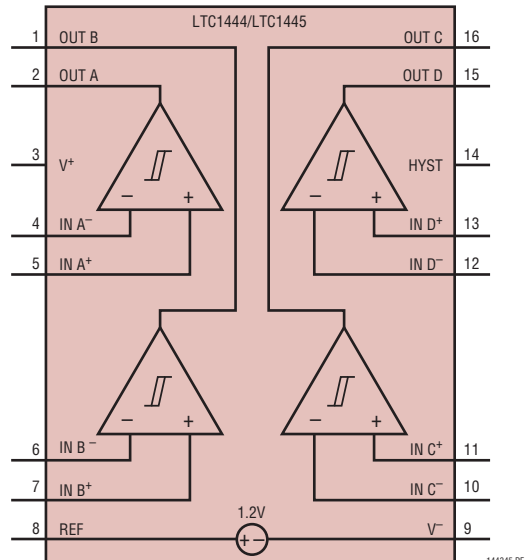
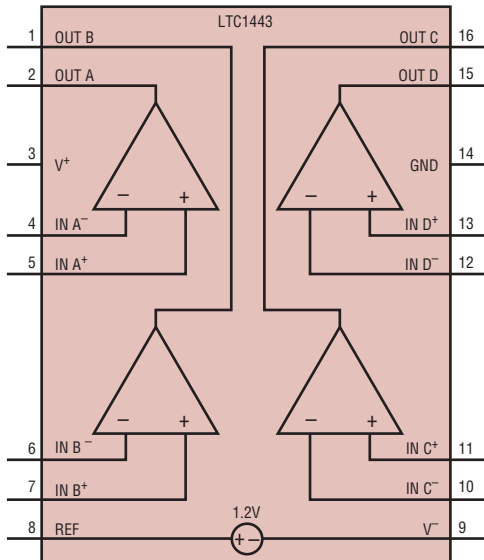

OUT B (Pin 1): Comparator B Output. (Open-drain output for LTC1444). Output can source up to 40mA (LTC1443, LTC1445) and sink 5mA.

OUT A (Pin 2): Comparator A Output. (Open-drain output for LTC1444). Output can source up to 40mA (LTC1443, LTC1445) and sink 5mA.

V⁺ (Pin 3): Positive Supply.

IN A⁻ (Pin 4): Inverting Input of Comparator A. Input common mode range from V⁻ to V⁺ – 1.3V. Input current typically 10pA at 25°C.

IN A⁺ (Pin 5): Noninverting Input of Comparator A. Input common mode range from V⁻ to V⁺ – 1.3V. Input current typically 10pA at 25°C.

IN B⁻ (Pin 6): Inverting Input of Comparator B. Input common mode range from V⁻ to V⁺ – 1.3V. Input current typically 10pA at 25°C.

IN B⁺ (Pin 7): Noninverting Input of Comparator B. Input common mode range from V⁻ to V⁺ – 1.3V. Input current typically 10pA at 25°C.

REF (Pin 8): Reference Output. With respect to V⁻. Can source up to 200μA and sink 15μA at 25°C. Drive 0.01μF bypass capacitor without oscillation.

V⁻ (Pin 9): Negative Supply. Connect to ground for single supply operation on LTC1443.

IN C⁻ (Pin 10): Inverting Input of Comparator C. Input common mode range from V⁻ to V⁺ – 1.3V. Input current typically 10pA at 25°C.

IN C⁺ (Pin 11): Noninverting Input of Comparator C. Input common mode range from V⁻ to V⁺ – 1.3V. Input current typically 10pA at 25°C.

IN D⁻ (Pin 12): Inverting Input of Comparator D. Input common mode range from V⁻ to V⁺ – 1.3V. Input current typically 10pA at 25°C.

IN D⁺ (Pin 13): Noninverting Input of Comparator D. Input common mode range from V⁻ to V⁺ – 1.3V. Input current typically 10pA at 25°C.

GND (Pin 14): LTC1443 Ground. Connect to V⁻ for single supply operation.

HYST (Pin 14): LTC1444/LTC1445 Hysteresis Input. Connect to REF if not used. Input voltage range is from V_{REF} to V_{REF} – 50mV.

OUT D (Pin 15): Comparator D Output. (Open-drain output for LTC1444). Output can source up to 40mA (LTC1443, LTC1445) and sink 5mA.

OUT C (Pin 16): Comparator C Output. (Open-drain output for LTC1444). Output can source up to 40mA (LTC1443, LTC1445) and sink 5mA.

Exposed Pad (Pin 17, DFN Package): This pin is internally connected to V⁻. Connection is optional, but will improve thermal dissipation.

APPLICATIONS INFORMATION

The LTC1443/LTC1444/LTC1445 is a family of quad micropower comparators with a built-in reference (1.182V for the LTC1443 and 1.221V for the LTC1444/LTC1445). Features include programmable hysteresis (LTC1444/LTC1445), wide supply voltage range (2V to 11V) and the ability of the reference to drive up to a 0.01 μ F capacitor without oscillation. The comparator CMOS outputs (LTC1443/LTC1445) can source up to 40mA while the LTC1444 has an open-drain output to V^- . The supply current glitches that normally occur when the comparator output switches states have been eliminated.

Power Supplies

The comparator family operates from a single 2V to 11V supply. The LTC1443 includes a separate ground for the comparator output stage, allowing a split supply ranging from ± 1 V to ± 5.5 V. Connecting V^- to GND on the LTC1443 allows single supply operation. If the comparator output is required to source more than 1mA or the supply source impedance is high, V^+ should be bypassed with a 0.1 μ F capacitor.

Comparator Inputs

The comparator inputs can swing from the negative supply (V^-) to within 1.3V maximum of the positive supply (V^+). The inputs can be forced 300mV below V^- or above V^+ without damage, and the typical input leakage current is only ± 10 pA.

Comparator Outputs

The LTC1443 comparator output swings between GND and V^+ to assure TTL compatibility with a split supply. The LTC1444 and LTC1445 outputs swing between V^- and V^+ . The outputs are capable of sourcing up to 40mA (LTC1443/LTC1445) and sinking up to 5mA while still maintaining microampere quiescent currents. The output stage does not generate crowbar switching currents during transitions which helps minimize parasitic feedback through the supply pins.

Voltage Reference

The internal bandgap reference has a voltage of 1.182V for LTC1443 or 1.221V for LTC1444/LTC1445 referenced to V^- . The reference accuracy is 1.5% from -40°C to 85°C . It can source up to 200 μ A and sink up to 15 μ A with a 5V supply. The reference can drive a bypass capacitor of up to 0.01 μ F without oscillation and by inserting a series resistor, capacitance values up to 100 μ F can be used (Figure 1).

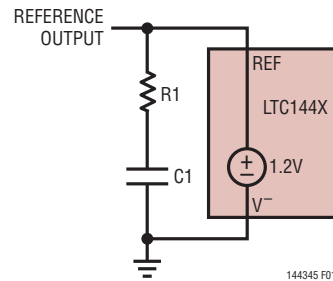

Figure 1. Damping the Reference Output

Figure 2 shows the resistor value required for different capacitor values to achieve critical damping.

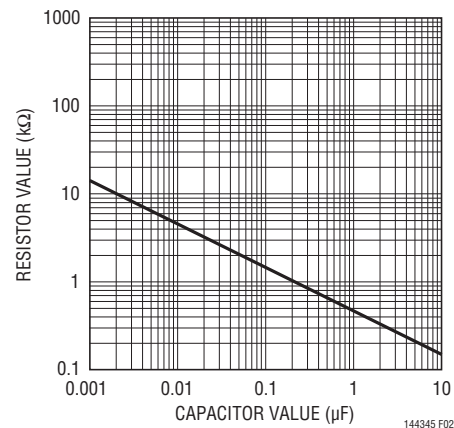

Figure 2. Damping Resistance vs Bypass Capacitor Value

APPLICATIONS INFORMATION

Bypassing the reference can help prevent false tripping of the comparators by preventing glitches on the V⁺ or the reference output voltage. Figure 3 shows the bypassed reference output with a square wave applied to the V⁺ pin. Resistors R1 and R2 set 10mV of hysteresis, while R3 damps the reference response. Note that the comparator output doesn't trip.

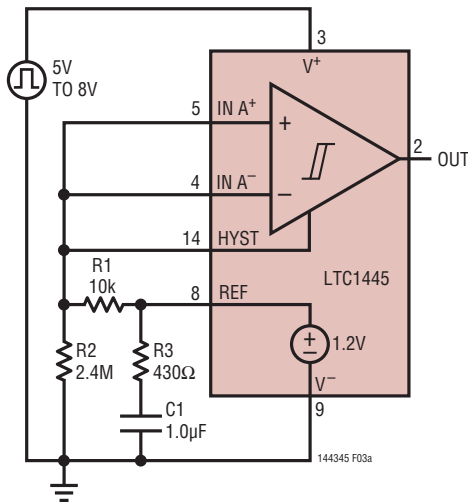

Figure 3a. V⁺ Glitching Test Circuit

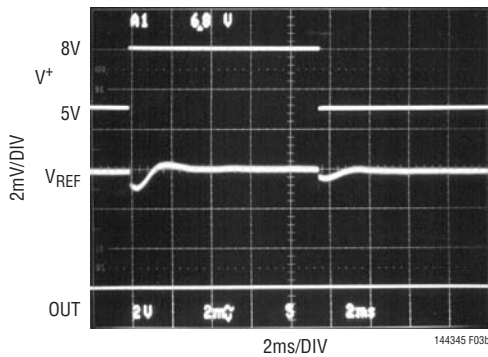

Figure 3b. V⁺ Glitching Response

Hysteresis

Hysteresis can be added to the LTC1444/LTC1445 by connecting a resistor (R1) between the REF and HYST pins, and a second resistor (R2) from HYST to V⁻ (Figure 4).

The difference between the upper and lower threshold voltages or hysteresis voltage band (V_{HB}) is equal to twice the voltage difference between the REF and HYST pins. When more hysteresis is added, the upper threshold increases the same amount as the lower threshold decreases. The maximum voltage allowed between REF and HYST is 50mV, producing a maximum hysteresis voltage band of 100mV. If hysteresis is not wanted, the HYST pin should be shorted to REF. Acceptable values for I_{REF} range from 0.1μA to 5μA. If 2.4M is chosen for R2, then R1(kΩ) = V_{HB} (mV).

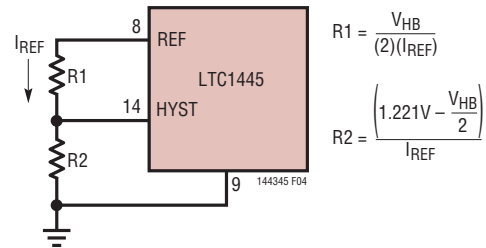

Figure 4. Programmable Hysteresis

APPLICATIONS INFORMATION

Level Detector

The LTC1444 is ideal for use as a multisupply micropower level detector as shown in Figure 5.

R1 and R2 form a voltage divider from V1 to the non-inverting comparator A input. R6 and R7 are used to divide down V2, while R8 is the output pull-up resistor for the comparator outputs. R3 and R4 set the hysteresis voltage and R5 and C1 bypass the reference output.

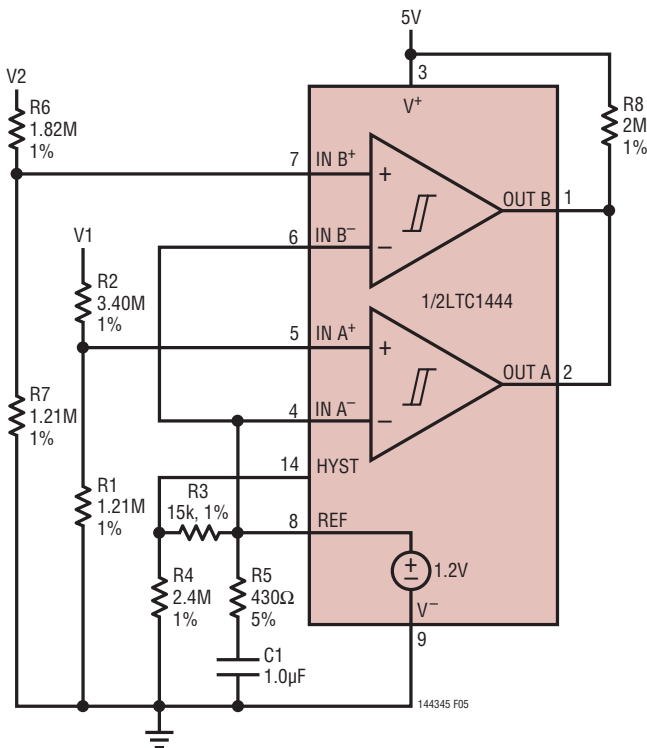

Figure 5. Glitch-Free Level Detector with Hysteresis

The following design procedure can be used to select the component values:

1. Choose the V1 voltage trip level, in this example 4.65V.
2. Calculate the required resistive divider ratio.

$$\text{Ratio} = V_{REF}/V_{IN}$$

$$\text{Ratio} = 1.221V/4.65V = 0.263$$

3. Choose the required hysteresis voltage band at the input, V_{HBIN} , in this example 60mV. Calculate the hysteresis voltage band referred to the comparator input V_{HB} .

$$V_{HB} = (V_{HBIN})(\text{Ratio})$$

$$V_{HB} = (60mV)(0.263)$$

$$V_{HB} = 15.78mV$$

4. Choose the values for R3 and R4 to set the hysteresis.

$$R4 = 2.4M$$

$$R3(k\Omega) = V_{HB} = 15k$$

5. Choose the values for R1 and R2 to set the trip point.

$$R1 = V_{REF}/I_{BIAS} = 1.221V/1\mu A \approx 1.21M$$

$$R2 = (R1) \left[\frac{V_{IN}}{V_{REF} + \frac{V_{HB}}{2}} - 1 \right]$$

$$R2 = (1.21M) \left[\frac{4.65V}{1.221V + \frac{15mV}{2}} - 1 \right]$$

$$R2 = 3.40M$$

Using the same equations, R6 and R7 are 1.82M and 1.21M, respectively, to set the trip level at 3V for V2.

PACKAGE DESCRIPTION

N Package
16-Lead PDIP (Narrow .300 Inch)
 (Reference LTC DWG # 05-08-1510 Rev I)

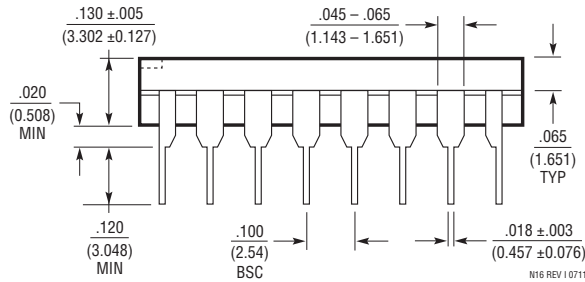
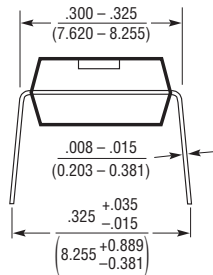
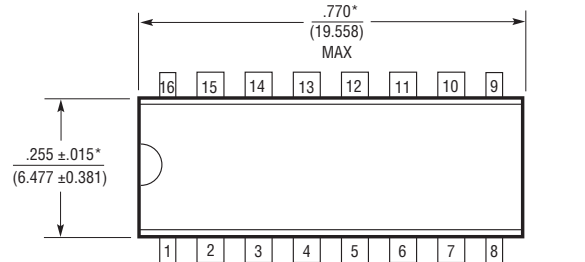

NOTE:
 1. DIMENSIONS ARE $\frac{\text{INCHES}}{\text{MILLIMETERS}}$
 *THESE DIMENSIONS DO NOT INCLUDE MOLD FLASH OR PROTRUSIONS.
 MOLD FLASH OR PROTRUSIONS SHALL NOT EXCEED .010 INCH (0.254mm)

S Package
16-Lead Plastic Small Outline (Narrow .150 Inch)
 (Reference LTC DWG # 05-08-1610 Rev G)

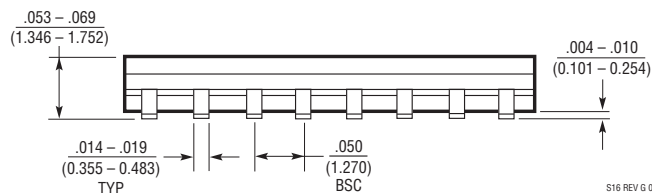
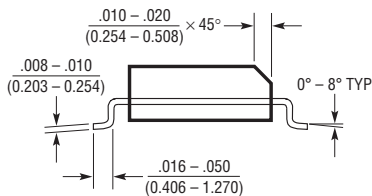
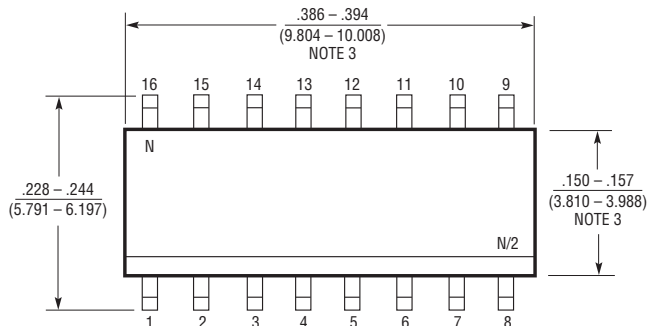
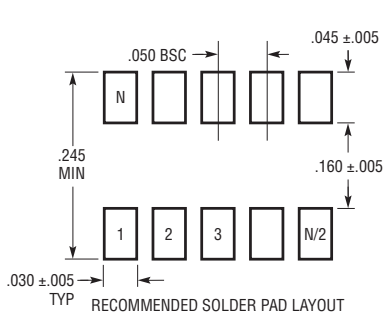

NOTE:
 1. DIMENSIONS IN $\frac{\text{INCHES}}{\text{MILLIMETERS}}$
 2. DRAWING NOT TO SCALE
 3. THESE DIMENSIONS DO NOT INCLUDE MOLD FLASH OR PROTRUSIONS.
 MOLD FLASH OR PROTRUSIONS SHALL NOT EXCEED .006" (0.15mm)
 4. PIN 1 CAN BE BEVEL EDGE OR A DIMPLE

REVISION HISTORY (Revision history begins at Rev D)

| REV | DATE | DESCRIPTION | PAGE NUMBER |
|-----|------|--|--------------------|
| D | 4/11 | Minor update to Figure 5 in the Applications Information section | 10 |
| E | 5/12 | Internal Voltage Reference Symbol Updated | 1, 7, 8, 9, 10, 14 |
| | | DFN Package Description Corrected | 2 |
| | | DFN Storage Temperature Range Increased to 150°C | 2 |
| | | Order Information Corrected | 3 |
| | | Related Parts Updated | 14 |

LTC1443/LTC1444/LTC1445

TYPICAL APPLICATION

Single Cell to 5V Supply

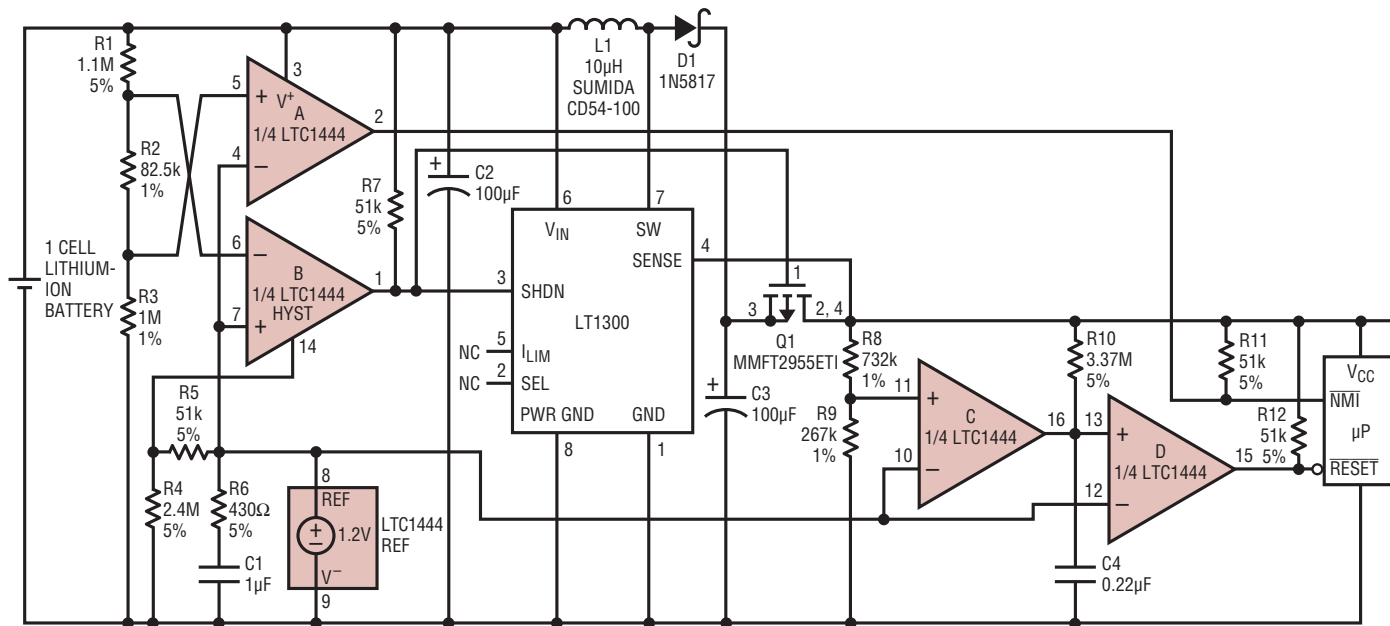

C2, C3: AUX TPSD107M010R0100 OR
SANYO OS-CON 16SA100M

144345 T403

RELATED PARTS

| PART NUMBER | DESCRIPTION | COMMENTS |
|----------------------|--|--|
| LTC1041 | Bang-Bang Controller with 1nA Off Current | 2.8V to 18V, Ideal for Temperature or Motor Control Circuit |
| LTC1042 | Micropower, High Accuracy Window Comparator | Fault Detect, Go/No Go Test, Supply Monitor |
| LTC1440/LTC1540 | Ultralow Power Comparator with Reference | 1.128V \pm 1% Reference, \pm 10mV (Max) Input Offset |
| LTC1441/LTC1442 | Dual Ultralow Power Comparators with Reference | 1.182V \pm 1% Reference, 8 μ s Prop Delay, 5.7 μ A |
| LTC1541/LTC1542 | Combined Amplifier, Comparator and Reference | 1.2V \pm 0.8 Reference, Amplifier Stable with 1000pF Load |
| LTC1842/LTC1843 | Dual Ultralow Power Comparators with Reference | 1.182V \pm 1% Reference, 4 μ s, 3.5 μ A, Open-Drain Out |
| LTC1921 | Dual Independent Monitors for -48V Supply and Fuse | -48V Telecom and Network Backplane Monitor |
| LTC1998 | High Accuracy Comparator with 1.2V Reference | Adjustable Threshold and Hysteresis, 2.5mA Supply |
| LT [®] 6700 | Dual Comparators with 400mV Reference | 1.4V to 18V Operation, 18 μ s Prop Delay, Available in SOT-23 and 2mm \times 3mm DFN Packages |
| LT6703 | Single Comparator with 400mV Reference | 1.4V to 18V Operation, 6.5 μ A Supply Current, Available in SOT-23 and 2mm \times 2mm DFN Packages |

144345fe