

DC-6.0 GHz InGaP HBT MMIC Matched Gain Block Amplifier

Mimix
BROADBAND™

April 2007 - Rev 04-Apr-07

CGB7016-BD
RoHS

Features

- ✕ Low Operating Voltage: 5V
- ✕ 34.0 dBm Output IP3 @ 850 MHz
- ✕ 3.8 dB Noise Figure @ 850 MHz
- ✕ 22.4 dB Gain @ 850 MHz
- ✕ 18.4 dBm P1dB @ 850 MHz
- ✕ Low Performance Variation Over Temperature
- ✕ 100% DC On-Wafer Testing
- ✕ ESD Protection on All Die: >1000V HBM
- ✕ Low Thermal Resistance: <85°C/Watt

Description

The CGB7016-BD is a Darlington Configured, high dynamic range, utility gain block amplifier. Designed for applications operating within the DC to 6.0 GHz frequency range, Mimix's broadband, cascadable, gain block amplifiers are ideal solutions for transmit, receive and IF applications.

These MMIC amplifiers are available in bare die form. Mimix's InGaP HBT technology and an industry low thermal resistance offers a thermally robust and reliable gain block solution.

The InGaP HBT die have extra pads to enable thorough DC testing. This unique test capability and the inclusion of ESD protection on all die, significantly enhances the quality, reliability and ruggedness of these products.

With a single bypass capacitor, optional RF choke and two DC blocking capacitors, this gain block amplifier offers significant ease of use in a broad range of applications.

Typical Performance

Parameter	Temperature (°C)	500 MHz			850 MHz			1950 MHz			2400 MHz			3500 MHz			Units
		Min.	Typ.	Max.	Min.	Typ.	Max.	Min.	Typ.	Max.	Min.	Typ.	Max.	Min.	Typ.	Max.	
Small Signal Gain	+25		23.4		21.4	22.4	23.4	18.0	19.0	20.0	16.8	17.8	18.8		14.6		dB
	-40 to +85		24.0		21.1	22.4	23.7	17.7	19.0	20.3	16.5	17.8	19.1		14.6		dB
Output P1dB	+25		18.6		17.4	18.4		16.2	17.2		15.1	16.1			13.5		dBm
	-40 to +85		21.2		17.1	18.4		15.9	17.2		14.8	16.1			13.5		dBm
Output IP3	+25		34.5		32.5	34.0		29.0	30.5		28.0	29.5			26.5		dBm
	-40 to +85		37.0		32.0	34.0		28.0	30.5		27.0	29.5			26.5		dBm
Noise Figure	+25		3.8			3.8	4.6		4.1	4.9		4.3	5.3		4.5		dB
	-40 to +85		3.8			3.8	5.0		4.1	5.3		4.3	5.7		4.5		dB
Operating Current	+25	73	78	83	73	78	83	73	78	83	73	78	83	73	78	83	mA
	-40 to +85	69	78	92	69	78	92	69	78	92	69	78	92	69	78	92	mA
Input Return Loss	+25		12		11	15		17	25		16	24			25		dB
	-40 to +85		12		10	15		16	25		15	24			25		dB
Output Return Loss	+25		12		10	13		13	18		13	18			12.5		dB
	-40 to +85		12		9	13		12	18		12	18			12.5		dB
Pout @ -45 dBc, ACP IS-95, 9 Forward Channels	+25					11.5			11.5								dBm
	-40 to +85					11.5			11.5								dBm

Notes: 1. Performance in Mimix eval board, $V_s = 5\text{ V}$, $I_d = 78\text{ mA}$ Typ., $R_{bias} = 12\ \Omega$, $Z_s = Z_l = 50\ \Omega$, OIP3 tone spacing = 1 MHz, Pout per tone = 6 dBm.
2. Values reflect performance in recommended application circuit.
3. Only on-wafer DC test is done. Devices are not tested for RF performance.

Chip Layout

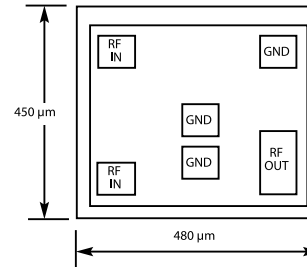

Absolute Maximum Ratings

Max Device Voltage	+6.0 V
Max Device Current	130 mA
Max Device Dissipated Power	0.65 W
RF Input Power	+17 dBm
Storage Temperature	-55°C to 150°C
Junction Temperature	150°C
Operating Temperature	-40°C to +85°C
Thermal Resistance	85° C/W
ESD (HBM)	1000 V

Operation of this device above any of these parameters may cause permanent damage.

Applications

- ✕ PA Driver Amp, IF Amp, LO Buffer Amp
- ✕ Cellular, PCS, GSM, UMTS
- ✕ Wireless Data and SATCOM
- ✕ Transmit and Receive Functions
- ✕ CATV

Mimix Broadband, Inc., 10795 Rockley Rd., Houston, Texas 77099
Tel: 281.988.4600 Fax: 281.988.4615 mimixbroadband.com

Page 1 of 7

Characteristic Data and Specifications are subject to change without notice. ©2007 Mimix Broadband, Inc.
Export of this item may require appropriate export licensing from the U.S. Government. In purchasing these parts, U.S. Domestic customers accept their obligation to be compliant with U.S. Export Laws.

DC-6.0 GHz InGaP HBT MMIC Matched Gain Block Amplifier



April 2007 - Rev 04-Apr-07

CGB7016-BD
RoHS

Typical S-Parameter and Noise Performance

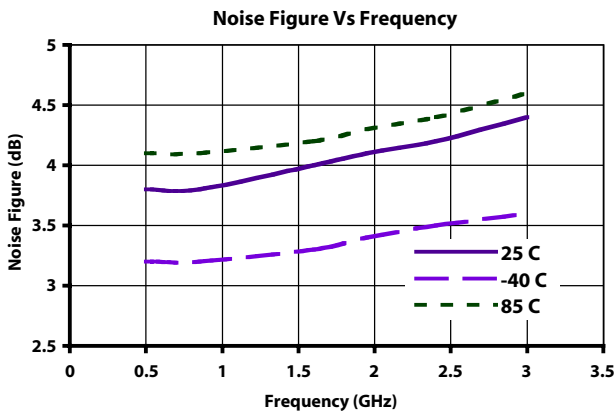
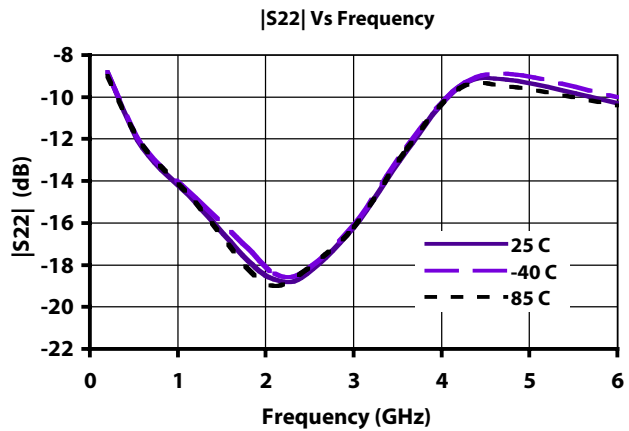
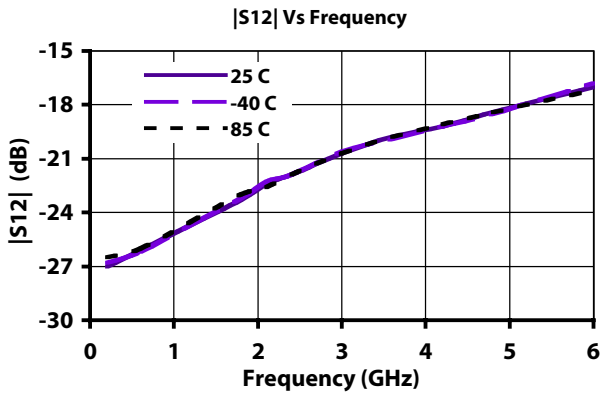
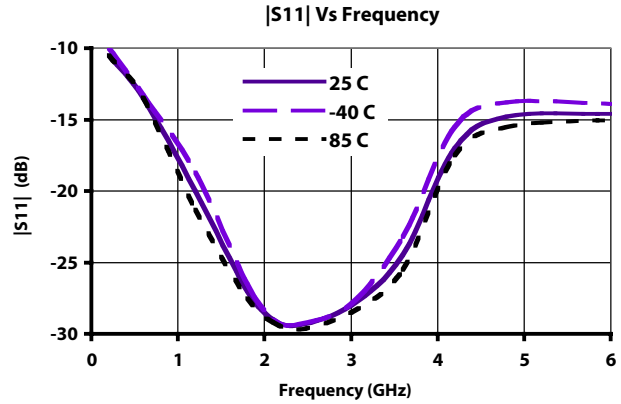
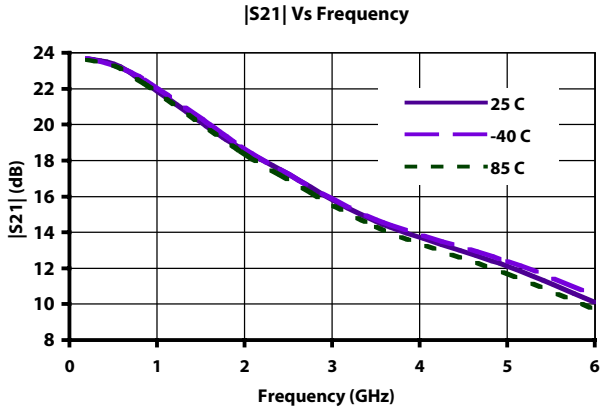

DC-6.0 GHz InGaP HBT MMIC Matched Gain Block Amplifier



April 2007 - Rev 04-Apr-07

CGB7016-BD
RoHS

Typical Power and Linearity Performance

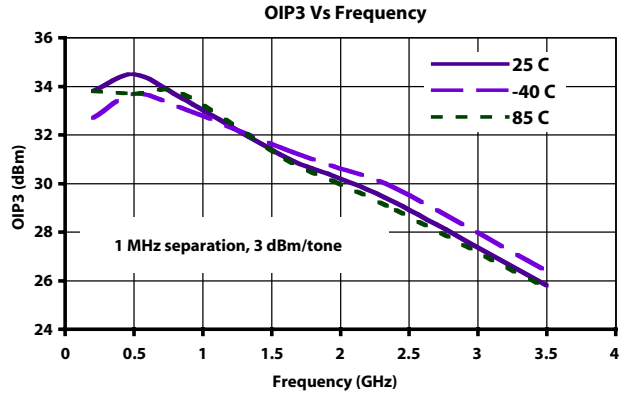
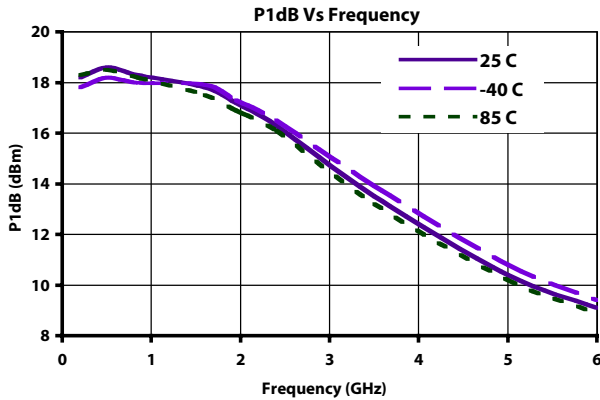

Linearity Performance - Base Station ACP - IS-95

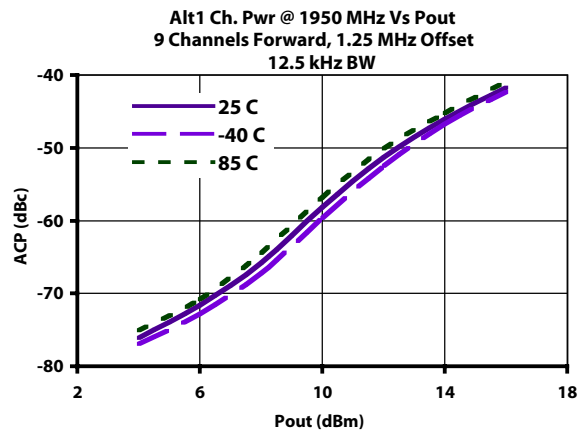
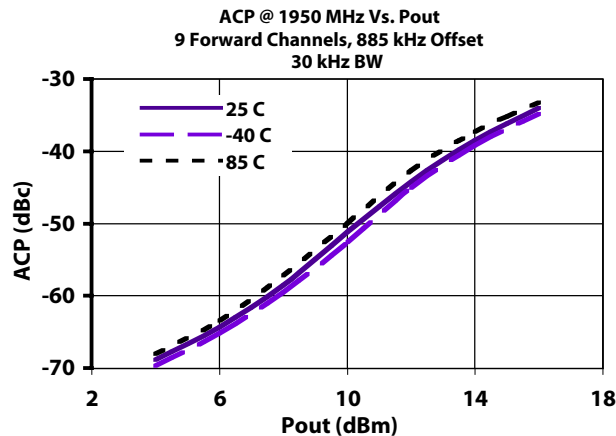
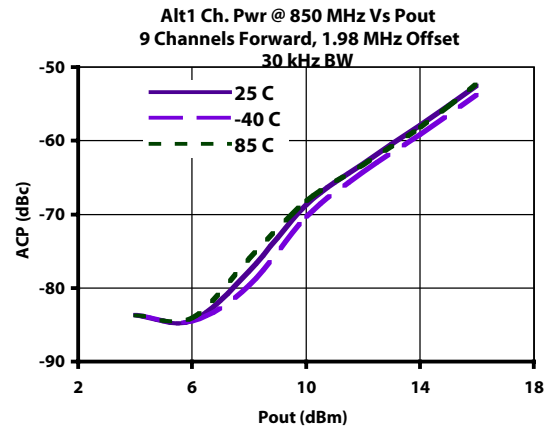
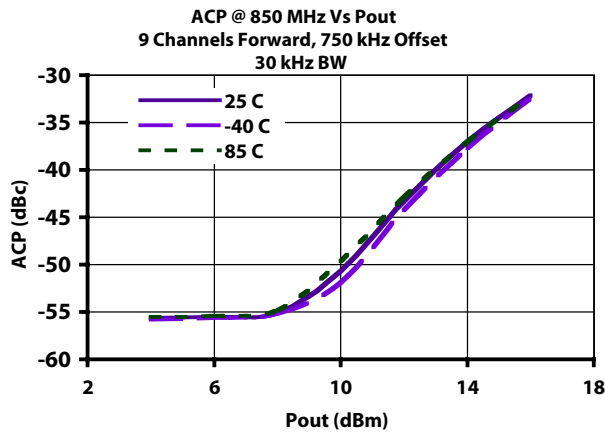

DC-6.0 GHz InGaP HBT MMIC Matched Gain Block Amplifier



April 2007 - Rev 04-Apr-07

CGB7016-BD
RoHS

Typical Scattering Parameters (Vd = +4.3V, Icc = 77 mA, T = 23°C, device in a 50 ohm system)

Frequency (MHz)	S ₁₁		S ₂₁		S ₁₂		S ₂₂	
	(Mag)	(Ang)	(Mag)	(Ang)	(Mag)	(Ang)	(Mag)	(Ang)
100	0.23	173	16.8	172	0.05	1	0.20	178
200	0.23	167	16.5	164	0.05	1	0.20	176
300	0.22	161	16.3	157	0.05	2	0.20	173
400	0.21	154	15.9	149	0.05	2	0.20	171
500	0.20	148	15.5	142	0.05	3	0.20	169
600	0.19	142	15.1	135	0.05	3	0.20	167
700	0.18	137	14.7	128	0.05	3	0.20	164
800	0.17	132	14.2	122	0.05	3	0.20	162
900	0.16	127	13.7	115	0.05	3	0.20	160
1000	0.15	122	13.2	109	0.06	3	0.20	158
1100	0.14	117	12.8	103	0.06	2	0.20	155
1200	0.12	112	12.3	97	0.06	2	0.20	153
1300	0.11	107	11.9	92	0.06	1	0.20	150
1400	0.10	102	11.4	86	0.06	1	0.20	148
1500	0.09	98	11.0	81	0.06	0	0.19	145
1600	0.08	94	10.6	76	0.07	-1	0.19	143
1700	0.07	89	10.2	70	0.07	-2	0.19	140
1800	0.06	85	9.9	66	0.07	-3	0.19	137
1900	0.05	80	9.5	61	0.07	-4	0.19	135
2000	0.04	75	9.2	56	0.07	-6	0.19	132
2100	0.03	70	8.9	51	0.08	-7	0.19	129
2200	0.03	64	8.6	47	0.08	-9	0.19	127
2300	0.02	57	8.3	42	0.08	-10	0.18	124
2400	0.01	45	8.0	38	0.08	-12	0.18	121
2500	0.01	17	7.8	33	0.08	-13	0.18	119
2600	0.01	-46	7.5	29	0.09	-15	0.18	116
2700	0.01	-85	7.3	25	0.09	-17	0.18	113
2800	0.01	-99	7.1	20	0.09	-19	0.18	110
2900	0.02	-112	6.9	16	0.09	-20	0.18	108
3000	0.02	-118	6.7	12	0.09	-22	0.18	105
3100	0.03	-124	6.5	8	0.10	-24	0.18	102
3200	0.03	-129	6.4	4	0.10	-26	0.18	100
3300	0.03	-135	6.2	0	0.10	-28	0.18	97
3400	0.03	-142	6.0	-4	0.10	-31	0.18	94
3500	0.04	-147	5.9	-8	0.10	-33	0.18	91
3600	0.04	-151	5.7	-12	0.11	-35	0.18	88
3700	0.04	-156	5.6	-16	0.11	-37	0.18	85
3800	0.04	-162	5.5	-20	0.11	-39	0.19	82
3900	0.04	-170	5.4	-24	0.11	-42	0.19	79
4000	0.04	-177	5.2	-28	0.12	-44	0.19	76
4100	0.03	175	5.1	-32	0.12	-46	0.20	73
4200	0.03	167	5.0	-36	0.12	-49	0.20	70
4300	0.03	158	4.9	-39	0.12	-51	0.21	67
4400	0.03	145	4.8	-43	0.12	-54	0.21	63
4500	0.03	130	4.7	-47	0.13	-56	0.22	60
4600	0.03	115	4.6	-51	0.13	-58	0.23	56
4700	0.03	100	4.5	-55	0.13	-61	0.23	53
4800	0.03	85	4.4	-59	0.13	-64	0.24	50
4900	0.04	71	4.3	-63	0.13	-66	0.25	47
5000	0.04	58	4.2	-67	0.14	-69	0.26	43

Continues Next Page. S-Parameter Data Files are available online at: www.mimixbroadband.com

Mimix Broadband, Inc., 10795 Rockley Rd., Houston, Texas 77099
Tel: 281.988.4600 Fax: 281.988.4615 mimixbroadband.com

Page 4 of 7

Characteristic Data and Specifications are subject to change without notice. ©2007 Mimix Broadband, Inc.
Export of this item may require appropriate export licensing from the U.S. Government. In purchasing these parts, U.S. Domestic customers accept their obligation to be compliant with U.S. Export Laws.

DC-6.0 GHz InGaP HBT MMIC Matched Gain Block Amplifier



April 2007 - Rev 04-Apr-07

CGB7016-BD
RoHS

Typical Scattering Parameters (Vd = +4.3V, Icc = 77 mA, T = 23°C, device in a 50 ohm system)

Frequency (MHz)	S ₁₁		S ₂₁		S ₁₂		S ₂₂	
	(Mag)	(Ang)	(Mag)	(Ang)	(Mag)	(Ang)	(Mag)	(Ang)
5100	0.05	48	4.1	-70	0.14	-72	0.27	39
5200	0.06	39	4.1	-74	0.14	-74	0.28	36
5300	0.07	32	4.0	-78	0.14	-77	0.29	33
5400	0.08	25	3.9	-82	0.14	-80	0.30	29
5500	0.09	19	3.8	-86	0.14	-82	0.31	26
5600	0.10	13	3.8	-90	0.15	-85	0.32	22
5700	0.11	8	3.7	-94	0.15	-88	0.33	19
5800	0.12	4	3.6	-98	0.15	-91	0.35	15
5900	0.14	-2	3.5	-102	0.15	-94	0.36	12
6000	0.15	-6	3.5	-106	0.15	-96	0.37	8
6100	0.16	-10	3.4	-109	0.15	-99	0.38	5
6200	0.18	-14	3.3	-113	0.15	-102	0.40	1
6300	0.19	-18	3.2	-117	0.15	-105	0.41	-2
6400	0.20	-22	3.2	-121	0.15	-108	0.43	-5
6500	0.22	-26	3.1	-125	0.15	-111	0.44	-9
6600	0.23	-30	3.0	-129	0.15	-114	0.45	-12
6700	0.25	-33	3.0	-133	0.16	-117	0.47	-15
6800	0.26	-37	2.9	-137	0.16	-120	0.48	-19
6900	0.28	-40	2.8	-141	0.16	-123	0.49	-22
7000	0.29	-44	2.8	-144	0.16	-126	0.51	-25
7100	0.30	-47	2.7	-148	0.15	-129	0.52	-28
7200	0.32	-51	2.6	-152	0.15	-132	0.53	-31
7300	0.33	-54	2.6	-156	0.15	-134	0.55	-35
7400	0.34	-57	2.5	-160	0.15	-137	0.56	-38
7500	0.35	-61	2.4	-163	0.15	-140	0.57	-41
7600	0.37	-64	2.4	-167	0.15	-143	0.58	-44
7700	0.38	-67	2.3	-171	0.15	-146	0.59	-47
7800	0.39	-70	2.2	-174	0.15	-149	0.60	-50
7900	0.40	-73	2.2	-178	0.15	-151	0.61	-52
8000	0.41	-76	2.1	-179	0.15	-154	0.62	-55
8100	0.42	-79	2.1	-175	0.15	-157	0.63	-58
8200	0.43	-82	2.0	-171	0.15	-159	0.64	-61
8300	0.43	-85	1.9	-168	0.15	-162	0.65	-63
8400	0.44	-88	1.9	-164	0.14	-165	0.66	-66
8500	0.45	-91	1.8	-161	0.14	-167	0.67	-69
8600	0.45	-94	1.8	-158	0.14	-170	0.67	-71
8700	0.46	-97	1.7	-154	0.14	-173	0.68	-74
8800	0.46	-99	1.7	-151	0.14	-175	0.68	-76
8900	0.47	-102	1.6	-148	0.14	-178	0.69	-79
9000	0.47	-105	1.6	-144	0.14	-180	0.70	-81
9100	0.47	-107	1.6	-141	0.14	-178	0.70	-83
9200	0.47	-110	1.5	-138	0.13	-175	0.71	-86
9300	0.48	-112	1.5	-135	0.13	-173	0.71	-88
9400	0.48	-115	1.4	-131	0.13	-170	0.71	-90
9500	0.48	-117	1.4	-128	0.13	-168	0.72	-92
9600	0.48	-120	1.4	-125	0.13	-166	0.72	-94
9700	0.47	-122	1.3	-122	0.13	-163	0.73	-96
9800	0.47	-125	1.3	-119	0.13	-161	0.73	-98
9900	0.47	-127	1.3	-116	0.12	-158	0.73	-100
10000	0.47	-130	1.2	-112	0.12	-156	0.73	-102

S-Parameter Data Files are available online at: www.mimixbroadband.com

Mimix Broadband, Inc., 10795 Rockley Rd., Houston, Texas 77099
Tel: 281.988.4600 Fax: 281.988.4615 mimixbroadband.com

Page 5 of 7

Characteristic Data and Specifications are subject to change without notice. ©2007 Mimix Broadband, Inc.
Export of this item may require appropriate export licensing from the U.S. Government. In purchasing these parts, U.S. Domestic customers accept their obligation to be compliant with U.S. Export Laws.

DC-6.0 GHz InGaP HBT MMIC Matched Gain Block Amplifier

April 2007 - Rev 04-Apr-07

Application Circuit

Note: This schematic represents the topology of the application circuit recommended by Mimix.

Recommended Bias Resistor Values for $I_D = 78 \text{ mA}$				
Supply Voltage (V_s)	5V	7V	8V	10V
Rbias (1/4W)	12 Ω	37 Ω	—	—
Rbias (1/2W)	—	—	50 Ω	76 Ω

Note: Rbias provides DC bias stability over temperature.

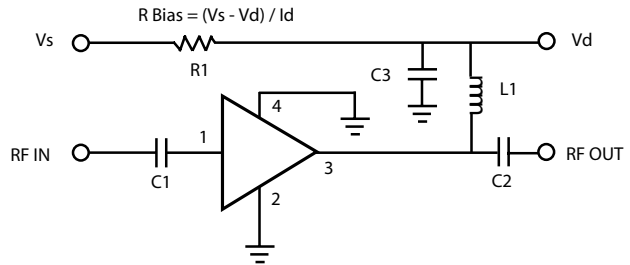

Physical Dimensions - BD (Bare Die)

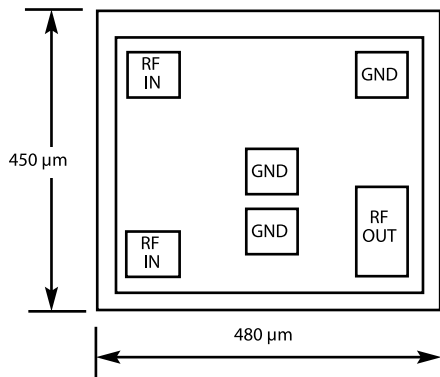

Notes:
RF OUT bonding pad is 75 μm x 155 μm .
All other pads are 75 μm x 75 μm .

Ref Designator	Value
C1, C2	1000 pF
C3	1.0 μF
L1	56 nH
R1	$R_{\text{Bias}} = (V_s - V_d) / I_d$

Bonding Configuration

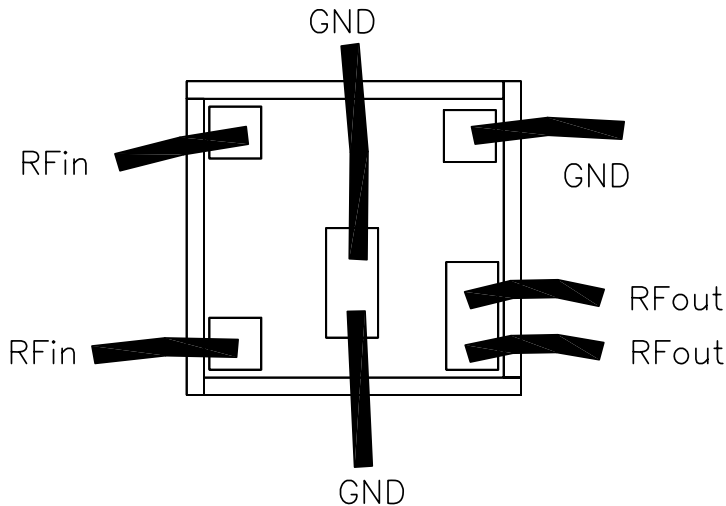

Caution: ESD Sensitive
Appropriate precautions in handling, packaging
and testing devices must be observed.

DC-6.0 GHz InGaP HBT MMIC Matched Gain Block Amplifier

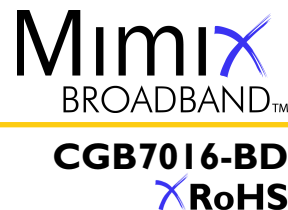

April 2007 - Rev 04-Apr-07

Handling and Assembly Information

CAUTION! - Mimix Broadband MMIC Products contain gallium arsenide (GaAs) which can be hazardous to the human body and the environment. For safety, observe the following procedures:

- *Do not ingest.*
- *Do not alter the form of this product into a gas, powder, or liquid through burning, crushing, or chemical processing as these by-products are dangerous to the human body if inhaled, ingested, or swallowed.*
- *Observe government laws and company regulations when discarding this product. This product must be discarded in accordance with methods specified by applicable hazardous waste procedures.*

Life Support Policy - Mimix Broadband's products are not authorized for use as critical components in life support devices or systems without the express written approval of the President and General Counsel of Mimix Broadband. As used herein: (1) Life support devices or systems are devices or systems which, (a) are intended for surgical implant into the body, or (b) support or sustain life, and whose failure to perform when properly used in accordance with instructions for use provided in the labeling, can be reasonably expected to result in a significant injury to the user. (2) A critical component is any component of a life support device or system whose failure to perform can be reasonably expected to cause the failure of the life support device or system, or to affect its safety or effectiveness.

ESD - Gallium Arsenide (GaAs) devices are susceptible to electrostatic and mechanical damage. Die are supplied in antistatic containers, which should be opened in cleanroom conditions at an appropriately grounded anti-static workstation. Devices need careful handling using correctly designed collets, vacuum pickups or, with care, sharp tweezers.

Die Attachment - GaAs Products from Mimix Broadband are 0.100 mm (0.004") thick. Microstrip substrates should be brought as close to the die as possible. The mounting surface should be clean and flat. If using conductive epoxy, recommended epoxies are Tanaka TS3332LD, Die Mat DM6030HK or DM6030HK-Pt cured in a nitrogen atmosphere per manufacturer's cure schedule. Apply epoxy sparingly to avoid getting any on to the top surface of the die. An epoxy fillet should be visible around the total die periphery. For additional information please see the Mimix "Epoxy Specifications for Bare Die" application note.

Wire Bonding - Windows in the surface passivation above the bond pads are provided to allow wire bonding to the die's gold bond pads. The recommended wire bonding procedure uses Gold 0.025 mm (0.001") diameter ball bonds. Aluminum wire should be avoided. Thermo-compression bonding is recommended though thermosonic bonding may be used providing the ultrasonic content of the bond is minimized. Bond force, time and ultrasonics are all critical parameters. Bonds should be made from the bond pads on the die to the package or substrate. All bonds should be as short as possible.

Part Number for Ordering	Description
CGB7016-BD-000V	RoHS compliant die packed in vacuum release gel paks