

Description

The GMM7402000DS/SG is a 2M x 40 bits Dynamic RAM MODULE which is assembled 20 pieces of 1M x 4 bit DRAMs in 20/26 pin SOJ package on both side the printed circuit board with decoupling capacitors. The GMM7402000DS/SG is optimized for application to the systems which are required high density and large capacity such as main memory of the computers and an image memory systems, and to the others which are requested compact size. The GMM7402000DS/SG provides common data inputs and outputs.

• GMM7402000DS/SG (Both Side)

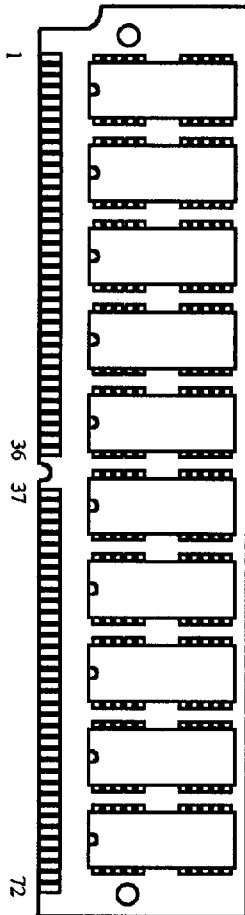

Features

- 72 pins Single In-Line Package
 - GMM7402000DS : Solder plating
 - GMM7402000DSG : Gold plating
- Fast Page Mode Capability
- Single Power Supply
- Fast Access Time & Cycle Time

(Unit: ns)

	t _{TRAC}	t _{CAC}	t _{RC}	t _{PC}
GMM7402000DS/SG-60	60	15	110	40
GMM7402000DS/SG-70	70	20	130	45
GMM7402000DS/SG-80	80	20	150	50

- Low Power
 - Active : 6,160/5,610/5,060 mW (MAX)
 - Standby : 110 mW (CMOS level : MAX)
- RAS Only Refresh, CAS before RAS Refresh, Hidden Refresh Capability
- All inputs and outputs TTL Compatible
- 1024 Refresh Cycles/16ms

Pin Configuration (Top View)

Pin	Symbol	Pin	Symbol	Pin	Symbol	Pin	Symbol
1	V _{SS}	19	\overline{OE}	37	DQ ₁₉	55	DQ ₂₈
2	DQ ₀	20	DQ ₈	38	DQ ₂₀	56	DQ ₂₉
3	DQ ₁	21	DQ ₉	39	$\overline{V_{SS}}$	57	DQ ₃₀
4	DQ ₂	22	DQ ₁₀	40	$\overline{CAS_0}$	58	DQ ₃₁
5	DQ ₃	23	DQ ₁₁	41	NC	59	V _{CC}
6	DQ ₄	24	DQ ₁₂	42	NC	60	DQ ₃₂
7	DQ ₅	25	DQ ₁₃	43	$\overline{CAS_1}$	61	DQ ₃₃
8	DQ ₆	26	DQ ₁₄	44	$\overline{RAS_0}$	62	DQ ₃₄
9	DQ ₇	27	DQ ₁₅	45	$\overline{RAS_1}$	63	DQ ₃₅
10	V _{CC}	28	A ₇	46	$\overline{DQ_{21}}$	64	DQ ₃₆
11	NC	29	DQ ₁₆	47	\overline{WE}	65	DQ ₃₇
12	A ₀	30	V _{CC}	48	V _{SS}	66	DQ ₃₈
13	A ₁	31	A ₈	49	DQ ₂₂	67	PD ₁
14	A ₂	32	A ₉	50	DQ ₂₃	68	PD ₂
15	A ₃	33	NC	51	DQ ₂₄	69	PD ₃
16	A ₄	34	NC	52	DQ ₂₅	70	PD ₄
17	A ₅	35	DQ ₁₇	53	DQ ₂₆	71	DQ ₃₉
18	A ₆	36	DQ ₁₈	54	DQ ₂₇	72	V _{SS}

Block Diagram

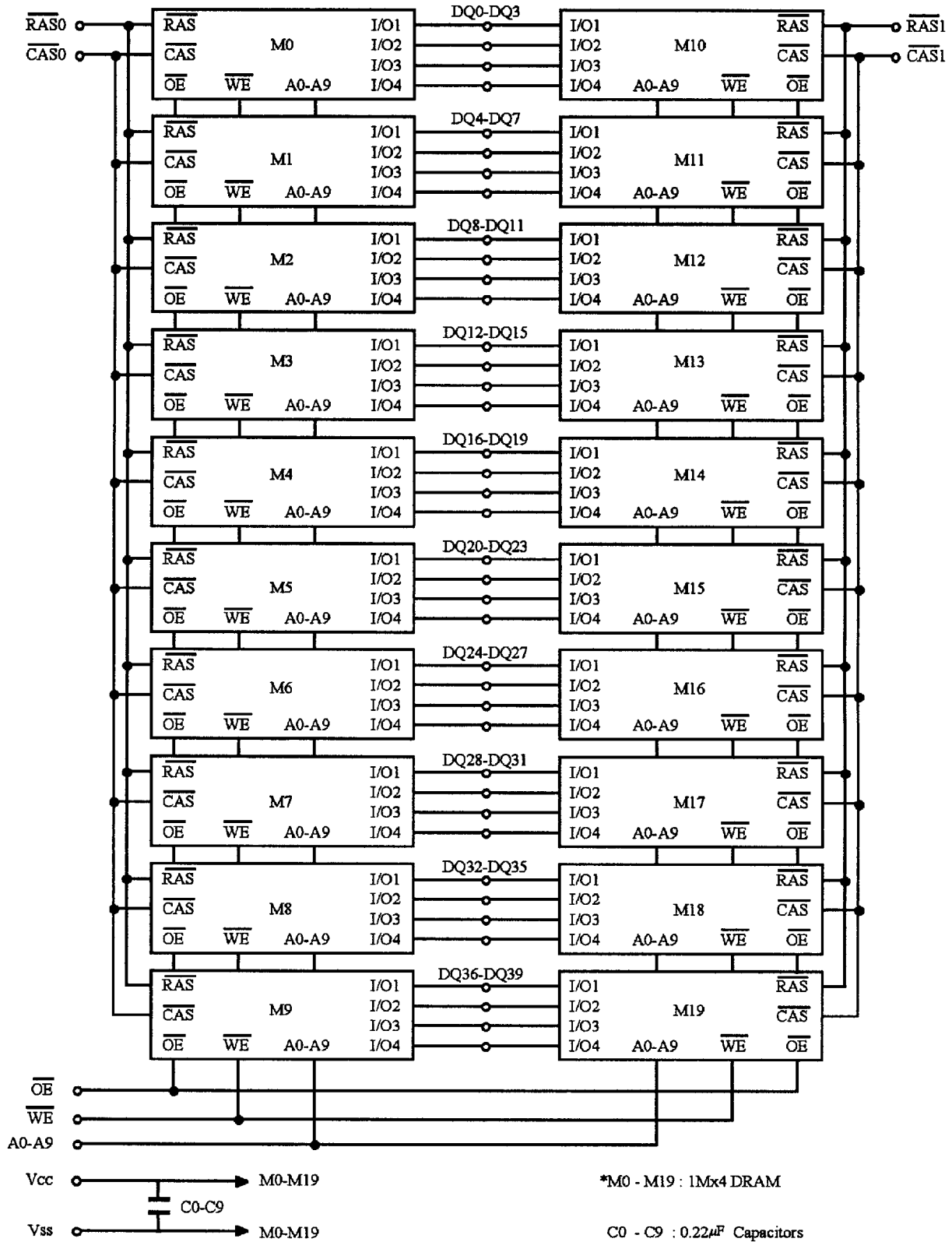

Pin Description

Pin	Function	Pin	Function
A0-A9	Address Inputs	PD1-PD4	Presence Detect
DQ0-DQ39	Data Input/Output	$\overline{\text{OE}}$	Output Enable
$\overline{\text{RAS0}}, \overline{\text{RAS1}}$	Row Address Strobe	V _{cc}	Power (+5V)
$\overline{\text{CAS0}}, \overline{\text{CAS1}}$	Column Address Strobe	V _{ss}	Ground
$\overline{\text{WE}}$	Read/Write Enable	NC	No Connection

Presence Detect Pins (Optional)

Pin	60ns	70ns	80ns
PD1	NC	NC	NC
PD2	NC	NC	NC
PD3	NC	V _{ss}	NC
PD4	NC	NC	V _{ss}

Absolute Maximum Ratings*¹

Symbol	Parameter	Rating	Unit
T _A	Ambient Temperature under Bias	0 ~ 70	°C
T _{STG}	Storage Temperature (Plastic)	-55 ~ 125	°C
V _{IN} /V _{OUT}	Voltage on any Pin Relative to V _{ss}	-1.0 ~ 7.0	V
V _{CC}	Power Supply Voltage	-1.0 ~ 7.0	V
I _{OUT}	Short Circuit Output Current	50	mA
P _D	Power Dissipation	20	W

*Note: 1. Stress greater than above "Absolute Maximum Ratings" may cause permanent damage to the device.

Recommended DC Operating Conditions (T_A = 0 ~ 70°C)

Symbol	Parameter	Min	Typ	Max	Unit	Note
V _{CC}	Supply Voltage	4.5	5.0	5.5	V	1
V _{IH}	Input High Voltage	2.4	-	6.5	V	1
V _{IL}	Input Low Voltage	-1.0	-	0.8	V	1

*Note: 1. All voltages referenced to V_{ss}.

DC Electrical Characteristics ($V_{CC} = 5V \pm 10\%$, $T_A = 0 \sim 70^\circ C$)

Symbol	Parameter	Min	Max	Unit	Note	
V_{OH}	Output Level Output "H" Level Voltage ($I_{OUT} = -5mA$)	2.4	V_{CC}	V		
V_{OL}	Output Level Output "L" Level Voltage ($I_{OUT} = 4.2mA$)	0	0.4	V		
I_{CC1}	Operating Current Average Power Supply Operating Current (\overline{RAS} , \overline{CAS} , Address Cycling: $t_{RC} = t_{RC \min}$)	60 ns	-	1120	mA	1, 2
		70 ns	-	1020		
		80 ns	-	920		
I_{CC2}	Standby Current (TTL) Power Supply Standby Current (\overline{RAS} , $\overline{CAS} = V_{IH}$)	-	40	mA		
I_{CC3}	\overline{RAS} Only Refresh Current Average Power Supply Current \overline{RAS} Only Mode (\overline{RAS} Cycling, $\overline{CAS} = V_{IH}$, $t_{RC} = t_{RC \min}$)	60 ns	-	1120	mA	2
		70 ns	-	1020		
		80 ns	-	920		
I_{CC4}	Fast Page Mode Current Average Power Supply Current Fast Page Mode ($\overline{RAS} = V_{IL}$, \overline{CAS} , Address Cycling: $t_{RC} = t_{RC \min}$)	60 ns	-	1120	mA	1, 3
		70 ns	-	1020		
		80 ns	-	920		
I_{CC5}	Standby Current (CMOS) Power Supply Standby Current (\overline{RAS} , $\overline{CAS} \geq V_{CC} - 0.2V$)	-	20	mA		
I_{CC6}	\overline{CAS} before \overline{RAS} Refresh Current ($t_{RC} = t_{RC \min}$)	60 ns	-	1120	mA	
		70 ns	-	1020		
		80 ns	-	920		
I_{CC7}	Standby Current $\overline{RAS} = V_{IH}$ $\overline{CAS} = V_{IL}$ $D_{OUT} = \text{Enable}$	-	100	mA	1	
I_{IL}	Input Leakage Current Any Input ($0V \leq V_{IN} \leq 7V$) All Other Pins Not Under Test = 0V	-200	200	μA		
I_{OL}	Output Leakage Current (D_{OUT} is Disabled, $0V \leq V_{OUT} \leq 7V$)	-20	20	μA		

Note: 1. I_{CC} depends on output load condition when the device is selected. $I_{CC}(\max)$ is specified at the output open condition.

2. Address can be changed once or less while $\overline{RAS} = V_{IL}$.
3. Address can be changed once or less while $\overline{CAS} = V_{IH}$.

Capacitance ($V_{CC} = 5V \pm 10\%$, $T_A = 25^\circ C$, $f = 1MHz$)

Symbol	Parameter	Min	Max	Unit	Note
C _{I1}	Input Capacitance (A0~A9)	-	130	pF	1
C _{I2}	Input Capacitance (\overline{WE} , \overline{OE})	-	160	pF	1, 2
C _{I3}	Input Capacitance ($\overline{RAS0}$, $\overline{RAS1}$)	-	90	pF	1, 2
C _{I4}	Input Capacitance ($\overline{CAS0}$, $\overline{CAS1}$)	-	90	pF	1, 2
C _{I/O}	I/O Capacitance (DQ0~DQ39)	-	25	pF	1, 2

Note: 1. Capacitance measured with Boonton Meter or effective capacitance measuring method.

2. $\overline{CAS} = V_{IH}$ to disable Dour.

AC Electrical Characteristics ($V_{CC} = 5V \pm 10\%$, $T_A = 0 \sim 70^\circ C$, Notes 1, 14)

The GMM7402000DS/SG writes data only in early write cycle ($twcs \geq twcs(\min)$).

Delayed write cycle is not available because of I/O common.

Read, Write and Refresh Cycle (Common Parameters)

Symbol	Parameter	GMM7402000 DS/SG-60		GMM7402000 DS/SG-70		GMM7402000 DS/SG-80		Unit	Note
		Min	Max	Min	Max	Min	Max		
t _{RC}	Random Read or Write Cycle Time	110	-	130	-	150	-	ns	
t _{RP}	\overline{RAS} Precharge Time	40	-	50	-	60	-	ns	
t _{RAS}	\overline{RAS} Pulse Width	60	10,000	70	10,000	80	10,000	ns	
t _{CAS}	\overline{CAS} Pulse Width	15	10,000	20	10,000	20	10,000	ns	
t _{ASR}	Row Address Setup Time	0	-	0	-	0	-	ns	
t _{RAH}	Row Address Hold Time	10	-	10	-	10	-	ns	
t _{ASC}	Column Address Setup Time	0	-	0	-	0	-	ns	
t _{CAH}	Column Address Hold Time	15	-	15	-	15	-	ns	
t _{RCD}	\overline{RAS} to \overline{CAS} Delay Time	20	45	20	50	20	60	ns	8
t _{RAD}	\overline{RAS} to Column Address Delay Time	15	30	15	35	15	40	ns	9
t _{RSH}	\overline{RAS} Hold Time	15	-	20	-	20	-	ns	
t _{CSH}	\overline{CAS} Hold Time	60	-	70	-	80	-	ns	
t _{CRP}	\overline{CAS} to \overline{RAS} Precharge Time	10	-	10	-	10	-	ns	
t _{ODD}	\overline{OE} to D _{IN} Delay Time	15	-	20	-	20	-	ns	
t _{DZO}	\overline{OE} Delay Time from D _{IN}	0	-	0	-	0	-	ns	
t _{DZC}	\overline{CAS} Set-up Time from D _{IN}	0	-	0	-	0	-	ns	
t _T	Transition Time (Rise and Fall)	3	50	3	50	3	50	ns	7
t _{REF}	Refresh Period (1024 Cycles)	-	16	-	16	-	16	ms	

Read Cycle

Symbol	Parameter	GMM7402000 DS/SG-60		GMM7402000 DS/SG-70		GMM7402000 DS/SG-80		Unit	Note
		Min	Max	Min	Max	Min	Max		
t _{TRAC}	Access Time from $\overline{\text{RAS}}$	-	60	-	70	-	80	ns	2, 3
t _{TCAC}	Access Time from $\overline{\text{CAS}}$	-	15	-	20	-	20	ns	3, 4
t _{TAA}	Access Time from Column Address	-	30	-	35	-	40	ns	3, 5
t _{TRCS}	Read Command Setup Time	0	-	0	-	0	-	ns	
t _{TRCH}	Read Command Hold Time to $\overline{\text{CAS}}$	0	-	0	-	0	-	ns	
t _{TRRH}	Read Command Hold Time to $\overline{\text{RAS}}$	0	-	0	-	0	-	ns	
t _{TRAL}	Column Address to $\overline{\text{RAS}}$ Lead Time	30	-	35	-	40	-	ns	
t _{TOAC}	Access Time from $\overline{\text{OE}}$	-	15	-	20	-	20	ns	3
t _{TOFF1}	Output Buffer Turn-off Time	0	15	0	20	0	20	ns	6
t _{TOFF2}	Output Buffer Turn-off Time from $\overline{\text{OE}}$	0	15	0	20	0	20	ns	6
t _{TCDD}	$\overline{\text{CAS}}$ to D _{IN} Delay Time	15	-	20	-	20	-	ns	

Write Cycle

Symbol	Parameter	GMM7402000 DS/SG-60		GMM7402000 DS/SG-70		GMM7402000 DS/SG-80		Unit	Note
		Min	Max	Min	Max	Min	Max		
t _{twcs}	Write Command Setup Time	0	-	0	-	0	-	ns	10
t _{twch}	Write Command Hold Time	15	-	15	-	15	-	ns	
t _{twp}	Write Command Pulse Width	10	-	10	-	10	-	ns	
t _{trwl}	Write Command to $\overline{\text{RAS}}$ Lead Time	15	-	20	-	20	-	ns	
t _{tcwl}	Write Command to $\overline{\text{CAS}}$ Lead Time	15	-	20	-	20	-	ns	
t _{tds}	Data-in Setup Time	0	-	0	-	0	-	ns	11
t _{tdh}	Data-in Hold Time	15	-	15	-	20	-	ns	11

Refresh Cycle

Symbol	Parameter	GMM7402000 DS/SG-60		GMM7402000 DS/SG-70		GMM7402000 DS/SG-80		Unit	Note
		Min	Max	Min	Max	Min	Max		
t _{CSR}	$\overline{\text{CAS}}$ Set-up Time ($\overline{\text{CAS}}$ -before- $\overline{\text{RAS}}$ Refresh Cycle)	10	-	10	-	10	-	ns	
t _{CHR}	$\overline{\text{CAS}}$ Hold Time ($\overline{\text{CAS}}$ -before- $\overline{\text{RAS}}$ Refresh Cycle)	10	-	10	-	10	-	ns	
t _{RPC}	$\overline{\text{RAS}}$ Precharge to $\overline{\text{CAS}}$ Hold Time	10	-	10	-	10	-	ns	
t _{CPN}	$\overline{\text{CAS}}$ Precharge Time in Normal Mode	10	-	10	-	10	-	ns	

Fast Page Mode Cycle

Symbol	Parameter	GMM7402000 DS/SG-60		GMM7402000 DS/SG-70		GMM7402000 DS/SG-80		Unit	Note
		Min	Max	Min	Max	Min	Max		
t _{PC}	Fast Page Mode Cycle Time	40	-	45	-	50	-	ns	
t _{CP}	Fast Page Mode $\overline{\text{CAS}}$ Precharge Time	10	-	10	-	10	-	ns	
t _{RASP}	Fast Page Mode $\overline{\text{RAS}}$ Pulse Width	-	100,000	-	100,000	-	100,000	ns	12
t _{ACP}	Access Time from $\overline{\text{CAS}}$ Precharge	-	35	-	40	-	45	ns	13
t _{RHCP}	$\overline{\text{RAS}}$ Hold Time from $\overline{\text{CAS}}$ Precharge	35	-	40	-	45	-	ns	

Notes:

1. AC measurements assume $t_r = 5 \text{ ns}$.
2. Assumes that $t_{rCD} \leq t_{rCD(\text{max})}$ and $t_{rAD} \leq t_{rAD(\text{max})}$. If t_{rCD} or t_{rAD} is greater than the maximum recommended value shown in this table, t_{rAC} exceeds the value shown.
3. Measured with a load circuit equivalent to 2TTL loads and 100pF.
4. Assumes that $t_{rCD} \geq t_{rCD(\text{max})}$ and $t_{rAD} \leq t_{rAD(\text{max})}$.
5. Assumes that $t_{rCD} \leq t_{rCD(\text{max})}$ and $t_{rAD} \geq t_{rAD(\text{max})}$.
6. $t_{\text{off}(\text{max})}$ defines the time at which the outputs achieve the open circuit condition and is not referenced to output voltage levels.
7. $V_{IH(\text{min})}$ and $V_{IL(\text{max})}$ are reference levels for measuring timing of input signals. Also, transition times are measured between V_{IH} and V_{IL} .
8. Operation with the $t_{rCD(\text{max})}$ limit insures that $t_{rAC(\text{max})}$ can be met, $t_{rCD(\text{max})}$ is specified as a reference point only, if t_{rCD} is greater than the specified $t_{rCD(\text{max})}$ limit, then access time is controlled exclusively by t_{CAC} .
9. Operation with the $t_{rAD(\text{max})}$ limit insures that $t_{rAC(\text{max})}$ can be met, $t_{rAD(\text{max})}$ is specified as a reference point only, if t_{rAD} is greater than the specified $t_{rAD(\text{max})}$ limit, then access time is controlled exclusively by t_{AA} .
10. t_{wCS} is not restrictive operating parameter. It is included in the data sheet as electrical characteristics only; If $t_{wCS} \geq w_{CS(\text{min})}$, the cycle is an early write cycle and the data out pin will remain open circuit (high impedance) throughout the entire cycle.
11. These parameters are referenced to $\overline{\text{CAS}}$ leading edge in early write cycles.
12. t_{trASP} is defines $\overline{\text{RAS}}$ pulse width in Fast Page Mode cycles.
13. Access time is determined by the longer of t_{AA} or t_{CAC} or t_{ACP} .
14. An initial pause of 100 μs is required after power up followed by a minimum of eight initialization cycles (any combination of cycles containing $\overline{\text{RAS}}$ clock such as $\overline{\text{RAS}}$ only refresh). If the internal refresh counter is used, a minimum of eight $\overline{\text{CAS}}$ before $\overline{\text{RAS}}$ refresh cycles are required.

Timing Waveforms

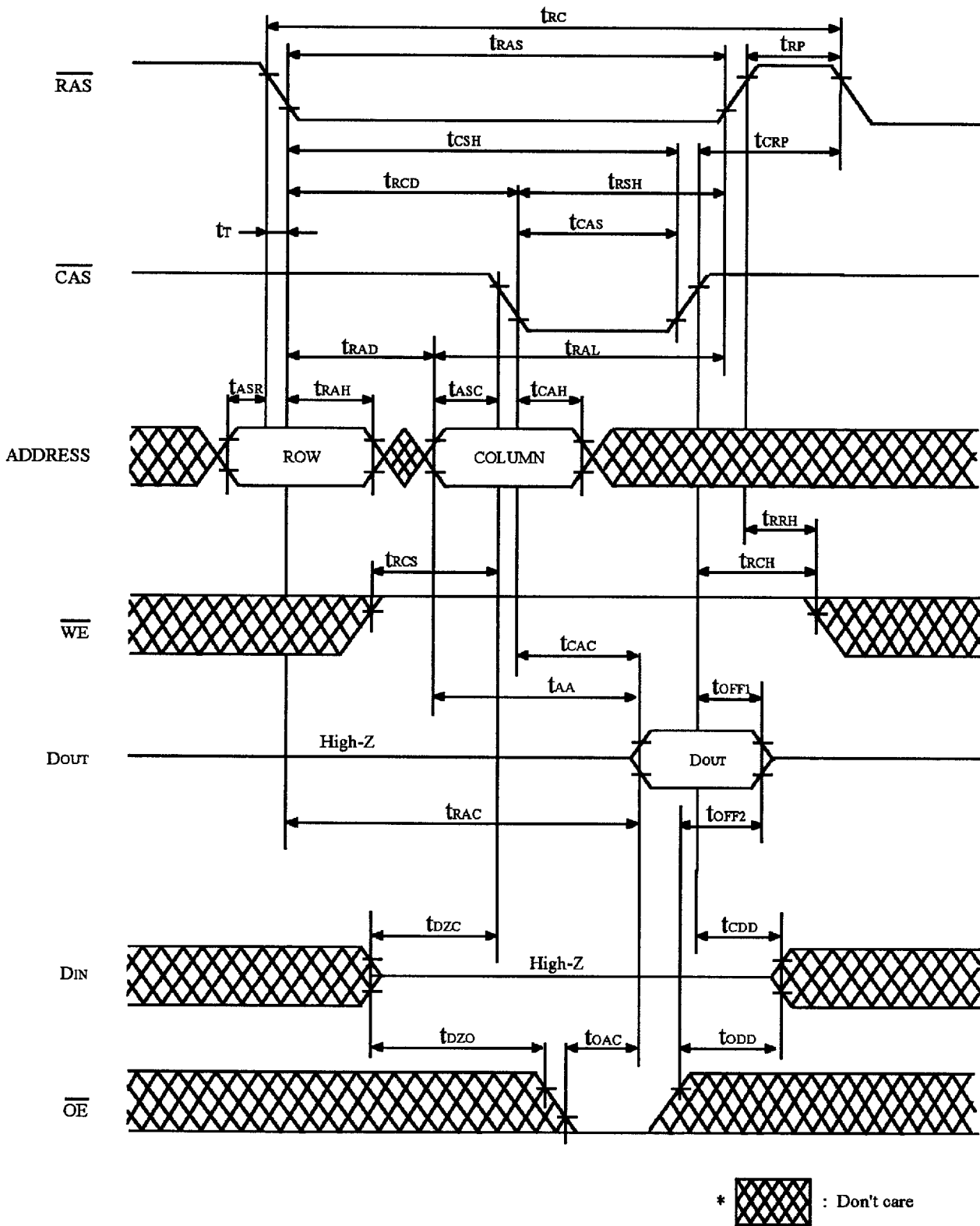
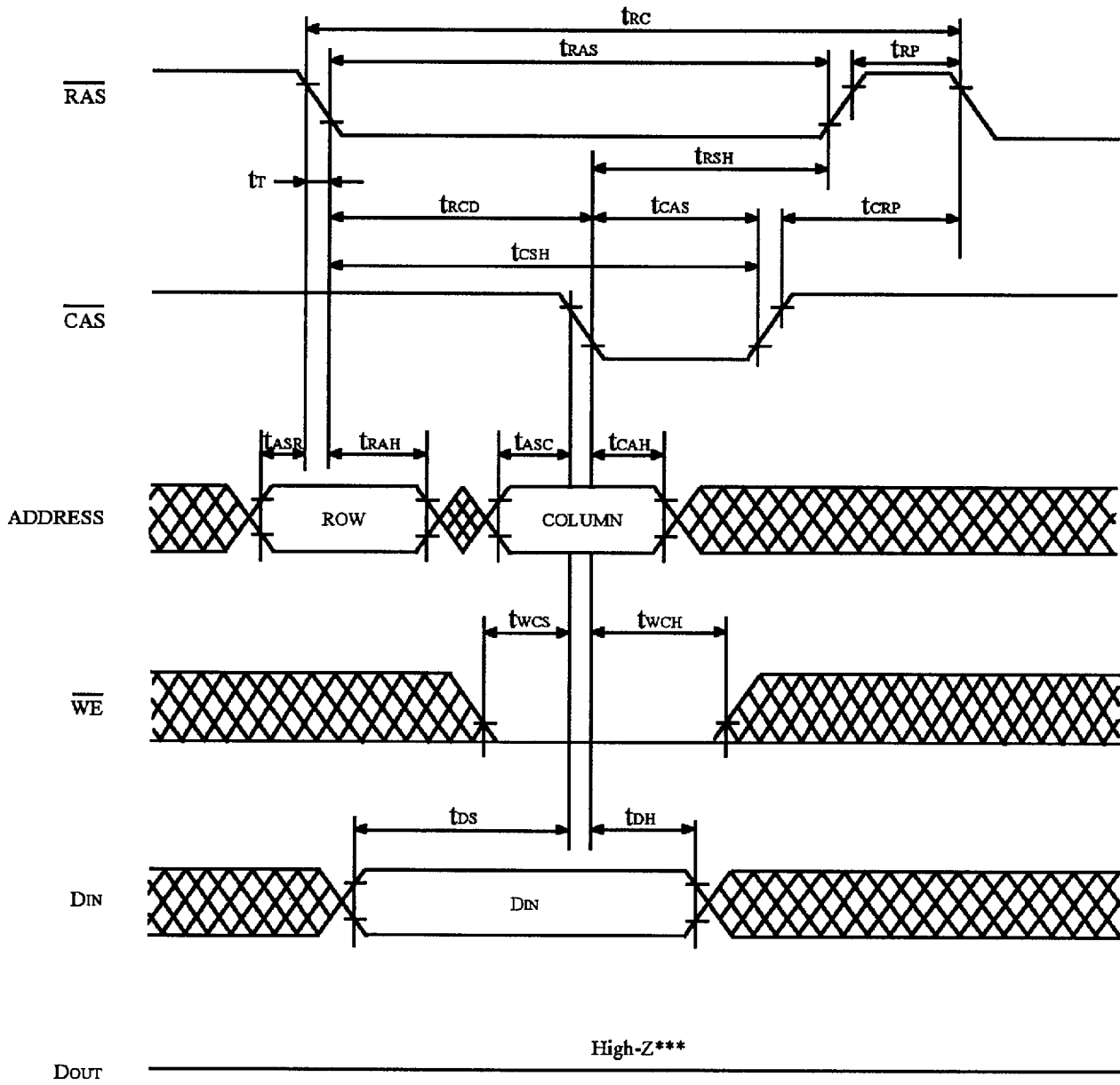

FIGURE 1. READ CYCLE



- *  : Don't care
- ** \overline{OE} : Don't care
- *** $t_{wcs} \geq t_{wcs}(\text{min})$

FIGURE 2. EARLY WRITE CYCLE



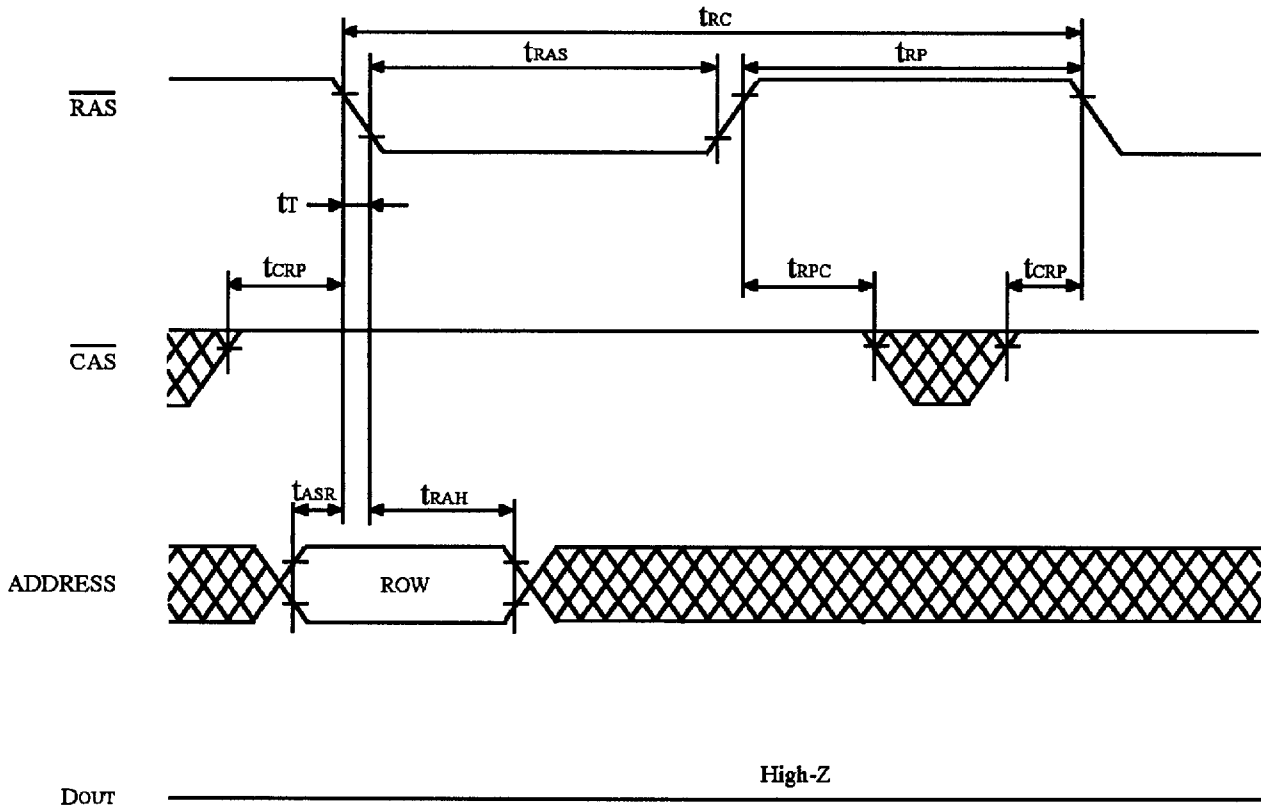

- *  : Don't care
- ** \overline{OE} , \overline{WE} : Don't care
- *** Refresh Address: A0-A9

FIGURE 3. \overline{RAS} ONLY REFRESH CYCLE

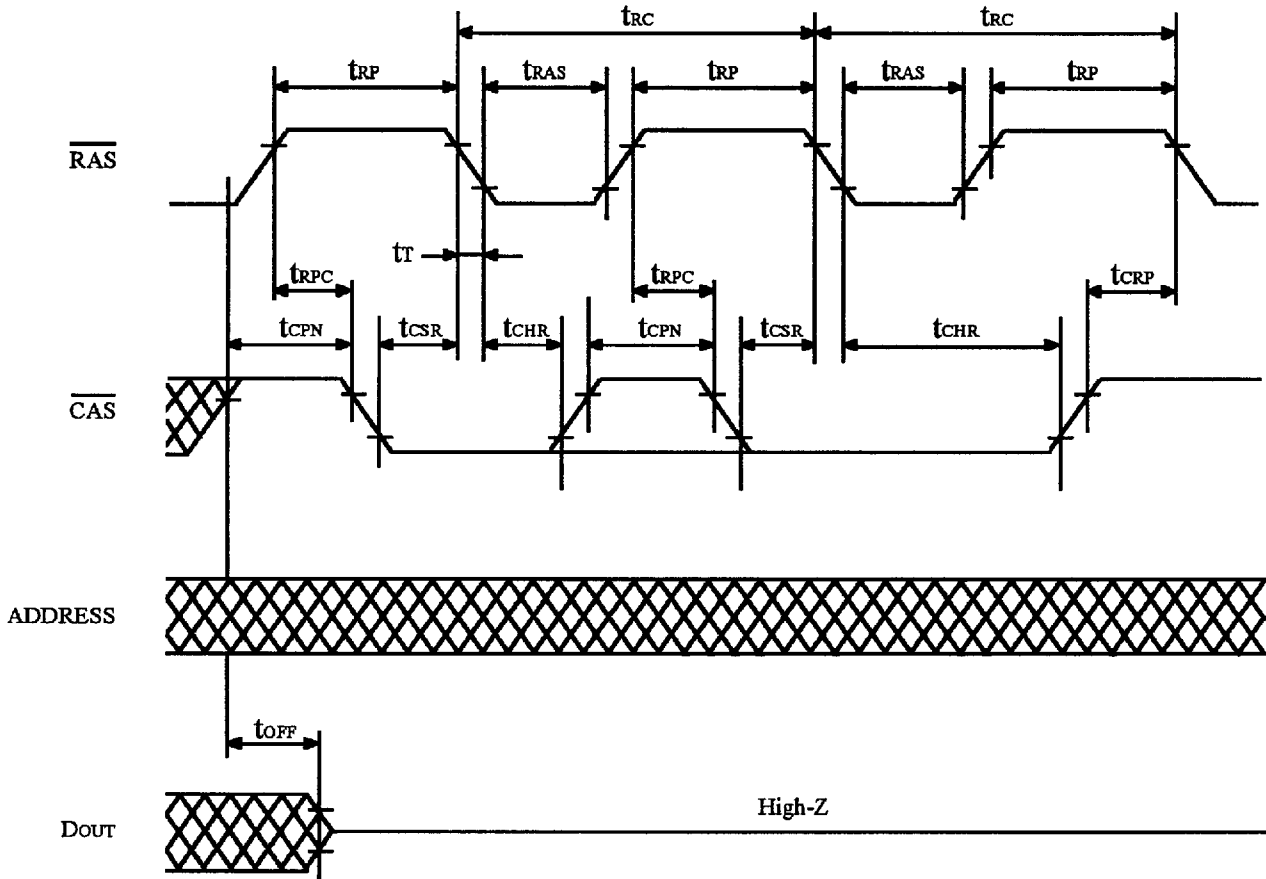

*  : Don't care

** \overline{WE} : V_{IH}

FIGURE 4. \overline{CAS} BEFORE \overline{RAS} REFRESH CYCLE

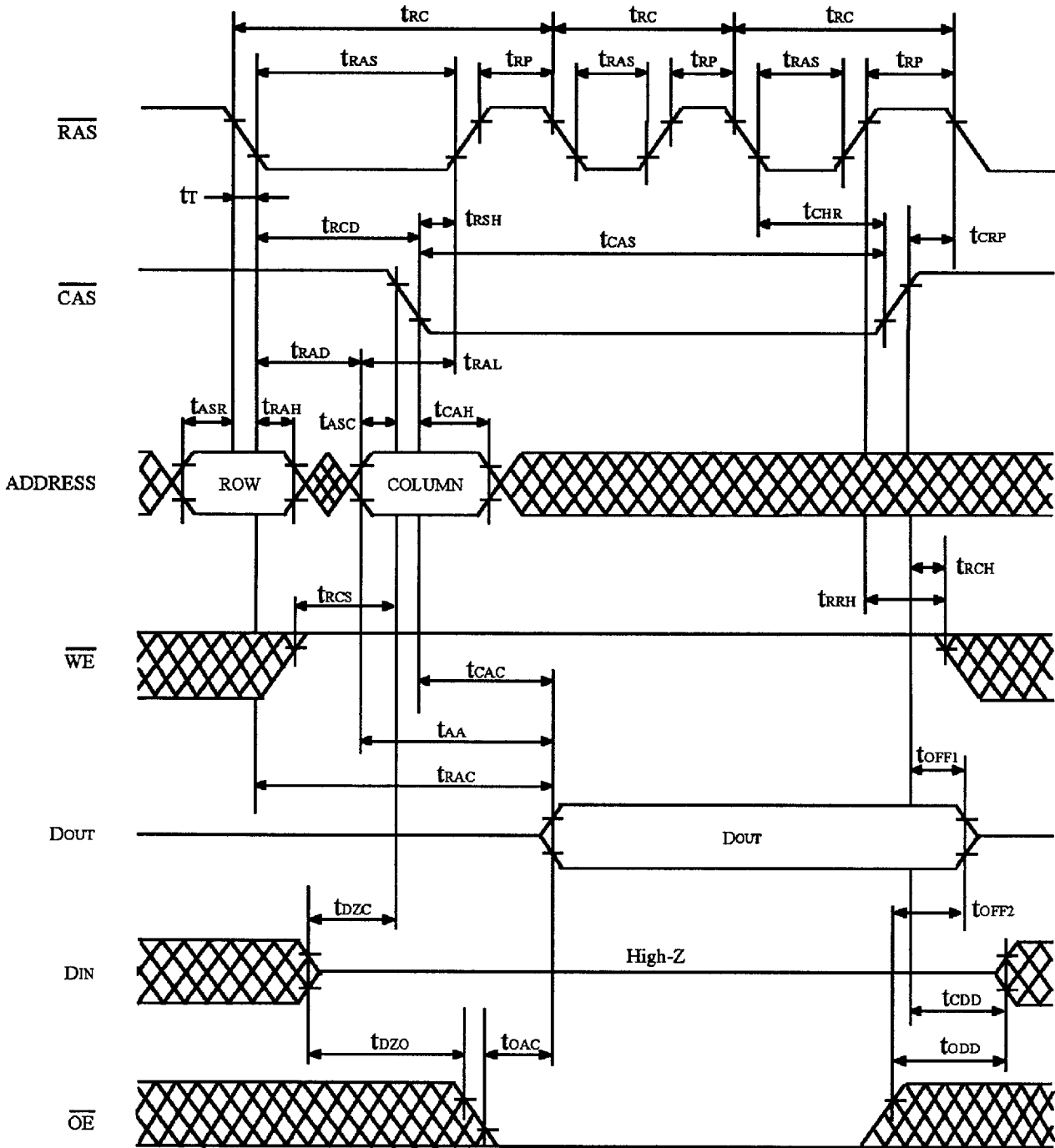

*  : Don't care

FIGURE 5. HIDDEN REFRESH CYCLE



*  : Don't care

FIGURE 6. FAST PAGE MODE READ CYCLE

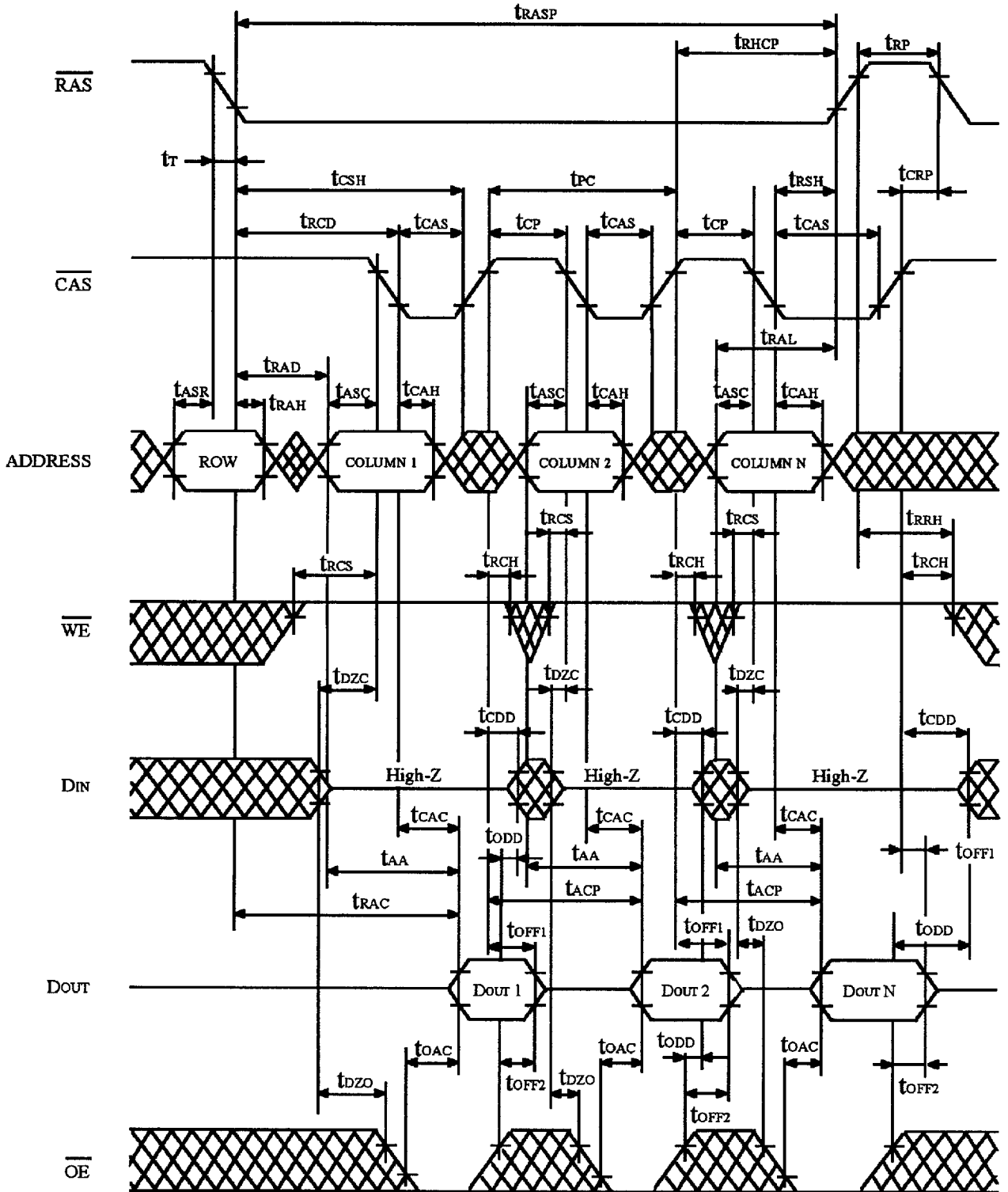
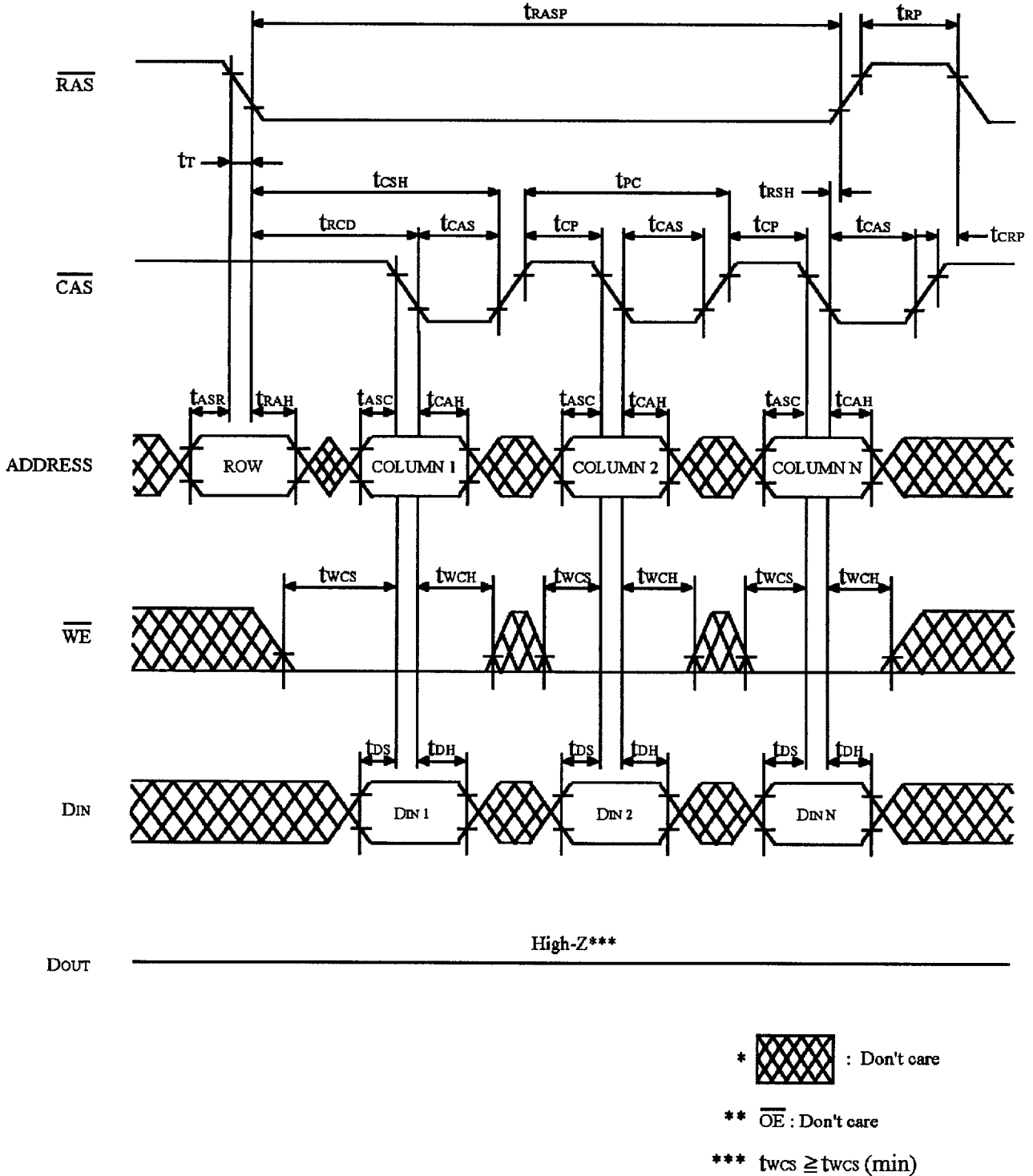
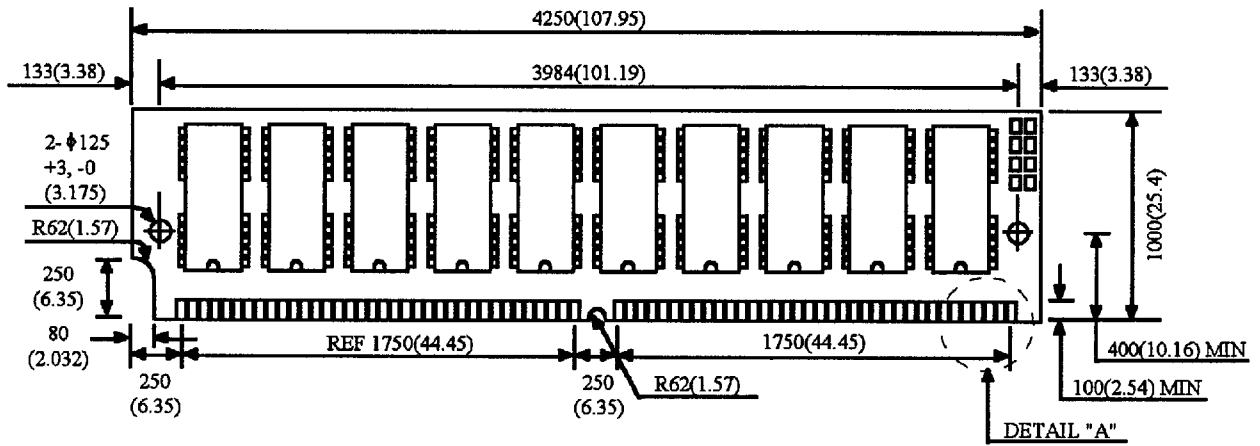

FIGURE 7. FAST PAGE MODE EARLY WRITE CYCLE

Package Dimensions

Unit: mil (mm)
 * (1mil = 1/1000 inches)

FRONT



REAR

