

ELECTRICAL SPECIFICATIONS:

- | | | |
|-----|--|---|
| 1.0 | 1.0 TURNS RATIO (P4-P5-P6) : (J3-J6) | : 1CT : 1CT ± 3% |
| | (P3-P2-P1) : (J1-J2) | : 1CT : 1CT ± 3% |
| 2.0 | 2.0 INDUCTANCE (P6-P4) | : 350uH MIN. @ 0.1V , 100KHz, 8mA DC Bias |
| | (P3-P1) | : 350uH MIN. @ 0.1V, 100KHz, 8mA DC Bias |
| 3.0 | 3.0 LEAKAGE INDUCTANCE P6-P5-P4 (WITH J6 AND J3 SHORT) | : 0.3 MAX. @ 1MHZ |
| | P3-P2-P1 (WITH J2 AND J1 SHORT) | : 0.3 MAX. @ 1MHZ |
| 4.0 | 4.0 INTERWINDING CAPACITANCE (P6,P5,P4) TO (J6,J3) | : 25pf TYP @ 1MHZ |
| | (P3,P2,P1) TO (J2,J1) | : 25pf TYP @ 1MHZ |
| 5.0 | 5.0 DC RESISTANCE (J6-J3)=(J2-J1) | : 1.2 ohms Max. |

NOTES

1.0 PINS
CONNEC

Stewart C
http://www
InNet Tec
http://www

SHEET
1 OF 4 DRAWING

6.0 RETURN LOSS: (P7-P8)=100 OHMS AND (P1-P2)=100 OHM REF.

1MHz TO 30MHz

: 18dB MIN.

30MHz TO 80MHz

: 12dB MIN.

NOTE: 100 OHMS CONNECTED TO (J2-J1) OR (J6-J3).

7.0 VOLTAGE WITHSTAND:

(J1, J2) TO (P1, P2)

: 1500 VAC

(J3, J6) TO (P7,P8)

: 1500 VAC

8.0 INSERTION LOSS: RS=RL=100 ohms

100KHz TO 100MHz

1.1 dB TYP

9.0 RISE TIME: RS=100 OHMS AND RL = 100 OHMS

OUTPUT VOLTAGE = 1 V peak

3.0 nS MAX

PULSE WIDTH= 112nS

3.0 nS MAX

10.0 CROSS TALK:

1-100 MHz

30 dB TYP

11.0 COMMON TO COMMON MODE ATTENUATION:

1MHz TO 100MHz

35dB TYP

Stewart C

<http://www>

InNet Tec

<http://www>

SHEET

2 OF 4

DRAWING

STANDARD LED	WAVELENGTH
YELLOW	590 nm
GREEN	565 nm

* WITH A FORWARD CURRENT

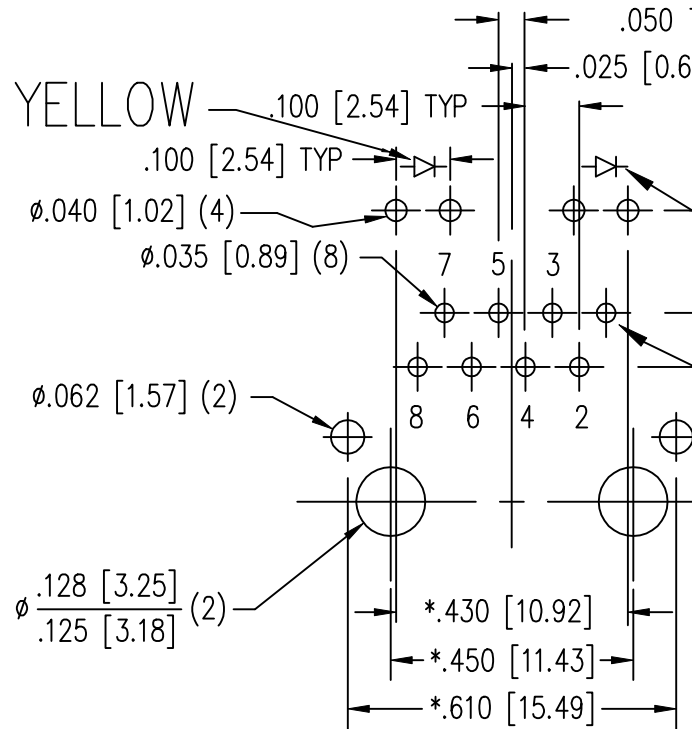
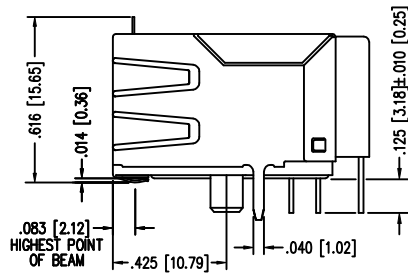
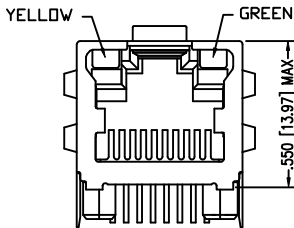
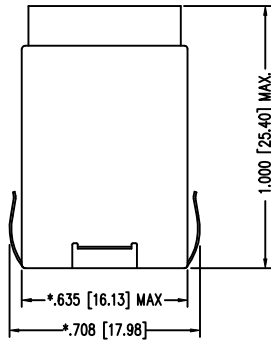

P.C.B. RECOMMENDED HOLE LAYOUT
 SEEN FROM COMPONENT SIDE
 TOLERANCE $\pm .003 [0.08]$ UNLESS OTHERWISE SPECIFIED

NOTES:

- TOLERANCES COMPLY WITH F.C.C. DIMENSION REQUIREMENTS
- DIMENSIONS SHOWN WITH "*" TO BE CENTRAL ABOUT CENTER LINE
- DIMENSIONS SHOWN ARE SUBJECT TO CHANGE WITHOUT NOTICE.
- PIN NOT ELECTRICALLY CONNECTED MAYBE OMITTED. SEE ELECTRICAL DRAWING FOR OMITTED PINS.

AVAILABLE WITH:

- STANDARD 50 MICRO-INCH SELECTIVE GOLD PLATING

CT750006

InNet http://www.innet.com	
Stewart http://www.stewart.com	
SHEET	D
3 of 4	

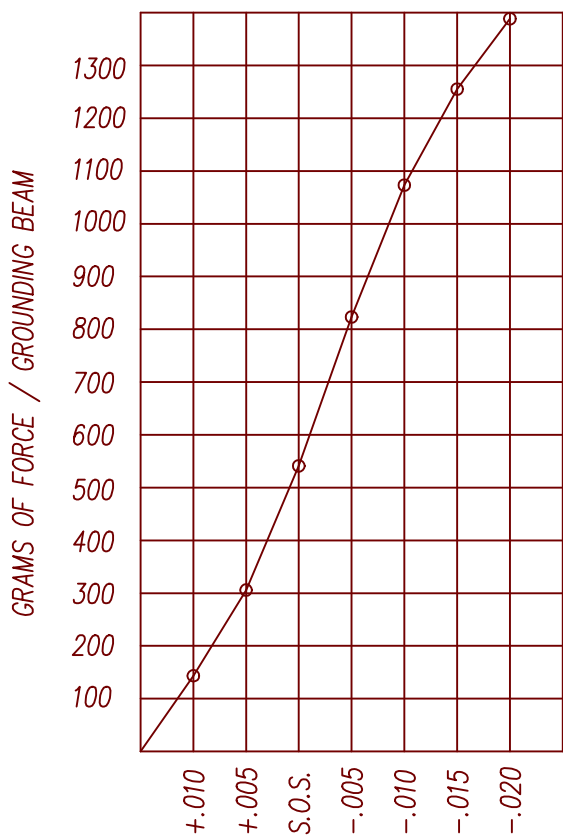

PANEL GROUNDING BEAM DEFLECTION
S.O.S. = SUGGESTED OPENING SIZE

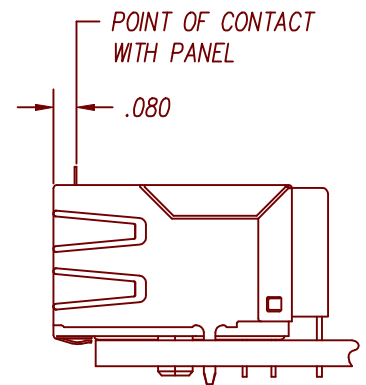

THE SUGGESTED PANEL OPENING IS INTENDED TO GIVE THE USER THE ABILITY TO HAVE REASONABLE JACK / PANEL CLEARANCES YET MAINTAIN RELIABLE GROUNDING CAPABILITY. THESE VARIABLES CAN BE ADJUSTED IN EITHER DIRECTION BUT MAY CARRY SOME CONSEQUENCES IN THE FORM OF LOWER MATING FORCES OR TIGHTER ASSEMBLY TOLERANCES. FORCE VALUES ON THE GRAPH ARE GENERAL AVERAGES TAKEN AT THE POINT OF CONTACT SHOWN ABOVE. THE SUGGESTED PANEL OPENING INCLUDES APPROXIMATELY .020 CLEARANCE ON THE SIDES AND TOP AND .013 ON THE BOTTOM, AT PANEL OPENING.

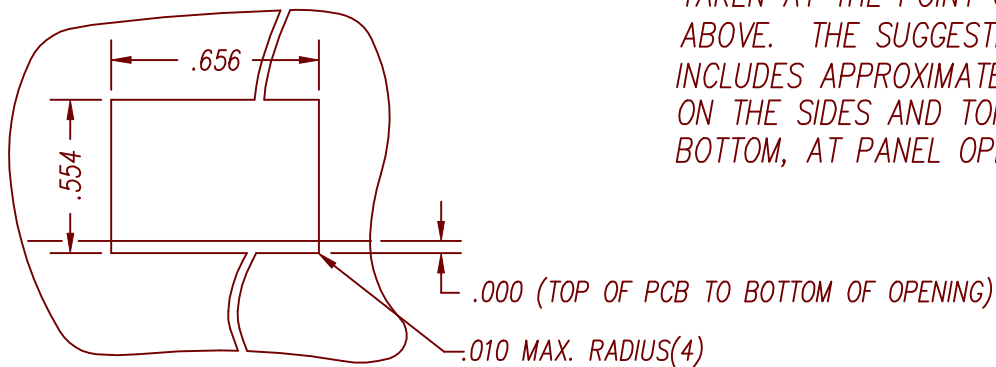

SUGGESTED PANEL OPENING