

PLEASE CHECK WWW.MOLEX.COM FOR LATEST PART INFORMATION

Part Number: [0026481206](#)
Status: **Active**
Description: 3.96mm (.156") Pitch KK® Header, Breakaway, Right Angle, with Friction Lock, 20 Circuits, Tin (Sn) Plating

Documents:

[3D Model](#) [Product Specification PS-08-50 \(PDF\)](#)
[Drawing \(PDF\)](#) [RoHS Certificate of Compliance \(PDF\)](#)
[Packaging Specification \(PDF\)](#)

Agency Certification

CSA LR19980
 UL E29179

General

Product Family PCB Headers
 Series [41672](#)
 Application Wire-to-Board
 Product Name KK®

Physical

Breakaway Yes
 Circuits (Loaded) 20
 Circuits (maximum) 20
 Color - Resin Black
 Durability (mating cycles max) 25
 Flammability 94V-0
 Glow-Wire Compliant No
 Lock to Mating Part Yes
 Material - Metal Brass
 Material - Plating Mating Tin
 Material - Plating Termination Tin
 Material - Resin Polyester
 Number of Rows 1
 Orientation Right Angle
 PC Tail Length (in) 0.212 In
 PC Tail Length (mm) 5.38 mm
 PCB Locator No
 PCB Retention None
 PCB Thickness Recommended (in) 0.062 In
 PCB Thickness Recommended (mm) 1.60 mm
 Packaging Type Bag
 Pitch - Mating Interface (in) 0.156 In
 Pitch - Mating Interface (mm) 3.96 mm
 Plating min: Mating (µin) 200
 Plating min: Mating (µm) 5
 Plating min: Termination (µin) 200
 Plating min: Termination (µm) 5
 Polarized to Mating Part No
 Polarized to PCB Yes
 Shrouded No
 Stackable No
 Temperature Range - Operating 0°C to +75°C
 Termination Interface: Style Through Hole

Electrical



image - Reference only

Series

EU RoHS

ELV and RoHS Compliant
REACH SVHC Contains SVHC: No
Halogen-Free Status
Not Reviewed

China RoHS



Need more information on product environmental compliance?

Email productcompliance@molex.com
 For a multiple part number RoHS Certificate of Compliance, [click here](#)

Please visit the [Contact Us](#) section for any non-product compliance questions.

Search Parts in this Series

[41672Series](#)

Mates With

[3069](#) , [3215](#) , [2139](#) , [2145](#) , [6442](#) , [7674](#) , [7675](#) , [41695](#) , [41815](#)

Current - Maximum per Contact	7A
Voltage - Maximum	250V

Solder Process Data

Duration at Max. Process Temperature (seconds)	5
Lead-free Process Capability	Wave Capable (TH only)
Max. Cycles at Max. Process Temperature	1
Process Temperature max. C	235

Material Info

Old Part Number	A-41672-A20A102
-----------------	-----------------

Reference - Drawing Numbers

Product Specification	PS-08-50
Sales Drawing	SD-41672-001, SD-41672-002

This document was generated on 03/22/2010

PLEASE CHECK WWW.MOLEX.COM FOR LATEST PART INFORMATION

CENTERLINE OF PIN IN AREA SHOWN NOT TO VARY FROM CENTERLINE OF PIN AT -D- BY MORE THAN 0.13/.005 IN ANY DIRECTION.

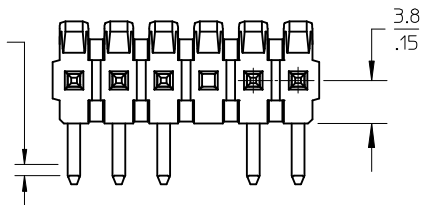

A-41672- * N * * * *
 OPTION - PACKING
 A= 2161 PIN- BULK PACK
 B= 43294 PIN- BULK PACK
 NO OF CKTS
 DIM M.L.P
 PLATING
 VOID LOCATIONS
 BLANK=NO VOIDS
 NO=CKT NO VOIDED
 MULT-VOIDS=51 UP

CIRCUIT	A	B
2	6.78/7.87 .267/1.310	3.96 .156
3	10.74/11.84 .423/1.466	7.92 .312
4	14.71/15.80 .579/1.622	11.89 .468
5	18.67/19.76 .735/1.778	15.85 .624
6	22.63/23.72 .891/1.934	19.81 .780
7	26.59/27.69 1.047/1.090	23.77 .936
8	30.56/31.65 1.203/1.246	27.74 1.092
9	34.52/35.61 1.359/1.402	31.70 1.248
10	38.48/39.57 1.515/1.558	35.66 1.404
11	42.44/43.54 1.671/1.714	39.62 1.560
12	46.41/47.50 1.827/1.870	43.59 1.716
13	50.37/51.46 1.983/2.026	47.55 1.872
14	54.33/55.42 2.139/2.182	51.51 2.028
15	58.29/59.39 2.295/2.338	55.47 2.184
16	62.26/63.35 2.451/2.494	59.44 2.340
17	66.22/67.31 2.607/2.650	63.40 2.496
18	70.18/71.27 2.763/2.806	67.36 2.652
19	74.14/75.23 2.919/2.962	71.32 2.808
20	78.11/79.20 3.075/3.118	75.29 2.964
21	82.07/83.16 3.231/3.274	79.25 3.120
22	86.03/87.12 3.387/3.430	83.21 3.276
23	89.94/91.08 3.541/3.586	87.17 3.432
24	93.85/95.00 3.695/3.740	91.14 3.588

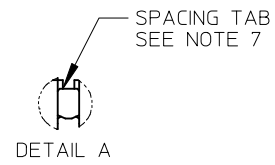
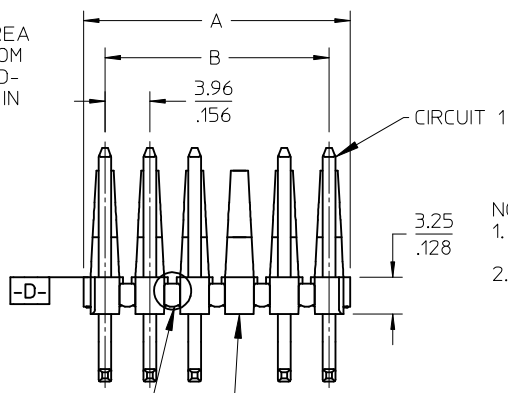
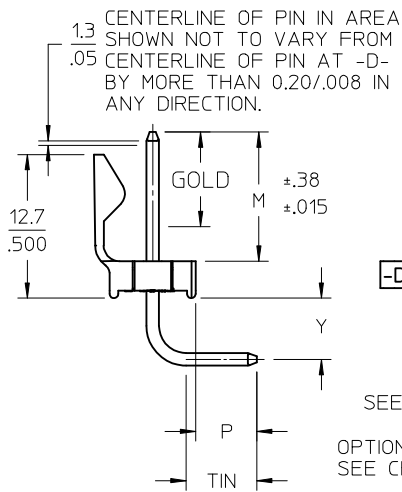

- NOTES:
 1. MATERIAL: HEADER: POLYESTER, 94V-0, MOLDED BLACK PIN: BRASS
 2. FINISH:
 (102) OVERALL TIN: 0.00508/.000200 MIN OVER 0.00254/.000100 MIN COPPER.
 (154) OVERALL TIN: 0.00254/.000100 MIN OVER 0.00127/.000050 MIN NICKEL.
 (208) SELECT GOLD: 0.00038/.000015 MIN, *SELECT TIN: 0.00254/.000100 MIN, OVERALL NICKEL UNDERPLATE: 0.00127/.000050 MIN.
 (228) SELECT GOLD: 0.00076/.000030 MIN, *SELECT TIN: 0.00254/.000100 MIN, OVERALL NICKEL UNDERPLATE: 0.00127/.000050 MIN.
 (501) OVERALL GOLD: 0.00051/.000020 MIN OVER 0.00076/.000030 MIN NICKEL.
 (503) OVERALL GOLD: 0.00076/.000030 MIN OVER 0.00127/.000050 MIN NICKEL.
 *THE PRIMARY SHIPPING CARTON WILL BE LABELED "COMPLIANT TO RoHS DIRECTIVE 2002/95/EC AND ELV ANNEX II OF DIRECTIVE 2000/53/EC". CARTONS WITHOUT THIS LABEL MAY CONTAIN PRODUCT WITH TIN/LEAD PLATINGS.
 3. PRODUCT SPECIFICATION: PS-08-50.
 4. PACKAGING INFORMATION: SEE TABLES
 5. SOLDERABILITY: PER SMES-152.
 6. PIN PUSH-OUT FORCE: PRIOR TO SOLDERING, A 3 LB. MINIMUM FORCE IN EITHER DIRECTION SHALL BE REQUIRED TO PUSH THE PIN OUT OF THE HEADER.
 7. PARTS ARE STACKABLE END TO END ON 3.96/.156 CENTERS.(SPACING TABS MUST BE REMOVED ON CIRCUIT SIZES 1-23 BEFORE PARTS ARE STACKABLE.
 8. PARTS WILL CONFORM TO CLASS B REQUIREMENTS OF COSMETIC SPECIFICATION PS-45499-002.

SEE DETAIL A
 OPTIONAL VOIDED CKT. SEE CHART FOR LOCATIONS

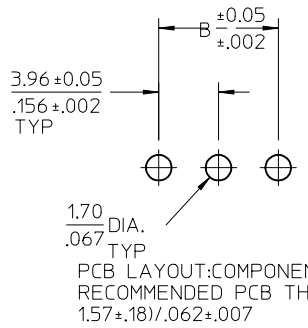

2-*	AB4
1	AB4
SHEET	REV

ADD 41672-0228	DESCRIPTION
EC NO: UCP2009-2938	
DRWN:MK LIPPER 2009/06/12	
CHKD:SSOUSEK 2009/06/15	
APPR:FSM TH 2009/06/15	
REV	REV
AB4	

QUALITY SYMBOLS
▽=0
▽=0

GENERAL TOLERANCES (UNLESS SPECIFIED)	
	DIMENSION STYLE MM/IN
	SCALE 2:1
	DESIGN UNITS INCH
	THIRD ANGLE PROJECTION
4 PLACES	± --- ± ---
3 PLACES	± --- ± .010
2 PLACES	± 0.25 ± .015
1 PLACE	± 0.38 ± ---
ANGULAR ±1/2°	
DRAFT WHERE APPLICABLE MUST REMAIN WITHIN DIMENSIONS	

DRAWN BY JSCHAFFER	DATE 12-5-03
CHECKED BY KSAMIEC	DATE 12-12-03
APPROVED BY MARGULIS	DATE 12-16-03
MATERIAL NO.	SEE CHART
SIZE A	

TITLE KK .156 HEADER ASSEMBLY FRICTION LOCK BREAKAWAY RIGHT ANGLE	
MOLEX MOLEX INCORPORATED	
DOCUMENT NO. SD-41672-001	SHEET NO. 1 OF *
THIS DRAWING CONTAINS INFORMATION THAT IS PROPRIETARY TO MOLEX INCORPORATED AND SHOULD NOT BE USED WITHOUT WRITTEN PERMISSION	

Header No:	41186-A-AN
Pin No:	2161-37(102)
Pin Length L	1.100 / 27.90
Mating M	.450 / 11.43
Gold:	NA
Bend Height: Y	.213 / 5.41
PC Tail P	.212 / 5.38
Tin:	OVERALL
Pack Per	PK-41672-001

Header No:	41186-A-AN
Pin No:	43294-0569
Pin Length L	1.100 / 27.90
Mating M	.450 / 11.43
Gold:	.270 / 6.86
Bend Height: Y	.213 / 5.41
PC Tail P	.212 / 5.38
Tin:	.200 / 5.08
Pack Per	PK-41672-001

Header No:	41186-A-AN
Pin No:	43294-0570
Pin Length L	1.100 / 27.90
Mating M	.450 / 11.43
Gold:	.270 / 6.86
Bend Height: Y	.213 / 5.41
PC Tail P	.212 / 5.38
Tin:	.200 / 5.08
Pack Per	PK-41672-001

Header No:	41186-A-AN
Pin No:	2161-37(501)
Pin Length L	1.100 / 27.90
Mating M	.450 / 11.43
Gold:	OVERALL
Bend Height: Y	.213 / 5.41
PC Tail P	.212 / 5.38
Tin:	NA
Pack Per	PK-41672-001

Ckts	Material No	Engineer Number	Material No	Engineer Number	Material No	Engineer Number	Material No	Engineer Number
2	026481026	A-41672-A02A102	41672-0001	A-41672-B02A208	41672-0024	A-41672-B02A228	026482026	A-41672-A02A501
3	026481036	A-41672-A03A102	41672-0002	A-41672-B03A208	41672-0025	A-41672-B03A228	026482036	A-41672-A03A501
4	026481046	A-41672-A04A102	41672-0003	A-41672-B04A208	41672-0026	A-41672-B04A228	026482046	A-41672-A04A501
5	026481056	A-41672-A05A102	41672-0004	A-41672-B05A208	41672-0027	A-41672-B05A228	026482056	A-41672-A05A501
6	026481066	A-41672-A06A102	41672-0005	A-41672-B06A208	41672-0028	A-41672-B06A228	026482066	A-41672-A06A501
7	026481076	A-41672-A07A102	41672-0006	A-41672-B07A208	41672-0029	A-41672-B07A228	026482076	A-41672-A07A501
8	026481086	A-41672-A08A102	41672-0007	A-41672-B08A208	41672-0030	A-41672-B08A228	026482086	A-41672-A08A501
9	026481096	A-41672-A09A102	41672-0008	A-41672-B09A208	41672-0031	A-41672-B09A228	026482096	A-41672-A09A501
10	026481106	A-41672-A10A102	41672-0009	A-41672-B10A208	41672-0032	A-41672-B10A228	026482106	A-41672-A10A501
11	026481116	A-41672-A11A102	41672-0010	A-41672-B11A208	41672-0033	A-41672-B11A228	026482116	A-41672-A11A501
12	026481126	A-41672-A12A102	41672-0011	A-41672-B12A208	41672-0034	A-41672-B12A228	026482126	A-41672-A12A501
13	026481136	A-41672-A13A102	41672-0012	A-41672-B13A208	41672-0035	A-41672-B13A228	026482136	A-41672-A13A501
14	026481146	A-41672-A14A102	41672-0013	A-41672-B14A208	41672-0036	A-41672-B14A228	026482146	A-41672-A14A501
15	026481156	A-41672-A15A102	41672-0014	A-41672-B15A208	41672-0037	A-41672-B15A228	026482156	A-41672-A15A501
16	026481166	A-41672-A16A102	41672-0015	A-41672-B16A208	41672-0038	A-41672-B16A228	026482166	A-41672-A16A501
17	026481176	A-41672-A17A102	41672-0016	A-41672-B17A208	41672-0039	A-41672-B17A228	026482176	A-41672-A17A501
18	026481186	A-41672-A18A102	41672-0017	A-41672-B18A208	41672-0040	A-41672-B18A228	026482186	A-41672-A18A501
19	026481196	A-41672-A19A102	41672-0018	A-41672-B19A208	41672-0041	A-41672-B19A228	026482196	A-41672-A19A501
20	026481206	A-41672-A20A102	41672-0019	A-41672-B20A208	41672-0042	A-41672-B20A228	026482206	A-41672-A20A501
21	026481216	A-41672-A21A102	41672-0020	A-41672-B21A208	41672-0043	A-41672-B21A228	026482216	A-41672-A21A501
22	026481226	A-41672-A22A102	41672-0021	A-41672-B22A208	41672-0044	A-41672-B22A228	026482226	A-41672-A22A501
23	026481236	A-41672-A23A102	41672-0022	A-41672-B23A208	41672-0045	A-41672-B23A228	026482236	A-41672-A23A501
24	026481246	A-41672-A24A102	41672-0023	A-41672-B24A208	41672-0046	A-41672-B24A228	026482246	A-41672-A24A501

REV: AB4	<u>ECR/ECN INFORMATION:</u>	<u>TITLE:</u> KK 156 HEADER ASSEMBLY FRICTION LOCK BREAKAWAY RIGHT ANGLE	<u>SHEET No.</u>	
	<u>EC No.:</u> UCP2009-2938		- 2 -	
	<u>DATE:</u> 6/15/2009			
<u>DOCUMENT NUMBER:</u> SD- 41672 -001		<u>CREATED / REVISED BY:</u> MKIPPER	<u>CHECKED BY:</u> SSOUSEK	<u>APPROVED BY:</u> FSMITH

Header No:	41186-A-AN
Pin No:	2161-96(501)
Pin Length L	1.531 / 38.89
Mating M	.500 / 12.70
Gold:	OVERALL
Bend Height: Y	.213 / 5.41
PC Tail P	.592 / 15.04
Tin:	NA
Pack Per	PK-41672-001

Header No:	41186-A-AN
Pin No:	2161-37(501)
Pin Length L	1.100 / 27.90
Mating M	.523 / 13.28
Gold:	OVERALL
Bend Height: Y	.213 / 5.41
PC Tail P	.136 / 3.45
Tin:	NA
Pack Per	PK-41672-001

Header No:	41186-A-AN
Pin No:	2161-19(102)
Pin Length L	1.032 / 26.21
Mating M	.458/11.63 REF
Gold:	NA
Bend Height: Y	.221 / 5.61
PC Tail P	.125+- .015
Tin:	OVERALL
Pack Per	PK-41672-001

Header No:	41186-A-AN
Pin No:	2161-19(102)
Pin Length L	1.032 / 26.21
Mating M	.461 / 11.71
Gold:	NA
Bend Height: Y	.213 / 5.41
PC Tail P	.130 / 3.30
Tin:	OVERALL
Pack Per	PK-41672-001

Ckts	Material No	Engineer Number	Material No	Engineer Number	Material No	Engineer Number	Material No	Engineer Number
2	41672-0109	A-41672-A02D501	026586020	A-41672-A02C501	026482029	A-41672-A02E102	41672-0151	A-41672-A02F102
3	41672-0110	A-41672-A03D501	026586030	A-41672-A03C501	026482039	A-41672-A03E102	41672-0152	A-41672-A03F102
4	41672-0111	A-41672-A04D501	41672-0131	A-41672-A04C501	026482049	A-41672-A04E102	41672-0153	A-41672-A04F102
5	41672-0112	A-41672-A05D501	41672-0132	A-41672-A05C501	026482059	A-41672-A05E102	41672-0154	A-41672-A05F102
6	41672-0113	A-41672-A06D501	41672-0133	A-41672-A06C501	026482069	A-41672-A06E102	41672-0155	A-41672-A06F102
7	41672-0114	A-41672-A07D501	41672-0134	A-41672-A07C501	026482079	A-41672-A07E102	41672-0156	A-41672-A07F102
8	41672-0115	A-41672-A08D501	026586080	A-41672-A08C501	026482089	A-41672-A08E102	41672-0157	A-41672-A08F102
9	41672-0116	A-41672-A09D501	41672-0135	A-41672-A09C501	026482099	A-41672-A09E102	41672-0158	A-41672-A09F102
10	41672-0117	A-41672-A10D501	41672-0136	A-41672-A10C501	026482109	A-41672-A10E102	41672-0159	A-41672-A10F102
11	41672-0118	A-41672-A11D501	41672-0137	A-41672-A11C501	026482119	A-41672-A11E102	41672-0160	A-41672-A11F102
12	41672-0119	A-41672-A12D501	41672-0138	A-41672-A12C501	026482129	A-41672-A12E102	41672-0161	A-41672-A12F102
13	41672-0120	A-41672-A13D501	41672-0139	A-41672-A13C501	026482139	A-41672-A13E102	41672-0162	A-41672-A13F102
14	41672-0121	A-41672-A14D501	41672-0140	A-41672-A14C501	026482149	A-41672-A14E102	41672-0163	A-41672-A14F102
15	41672-0122	A-41672-A15D501	41672-0141	A-41672-A15C501	026482159	A-41672-A15E102	41672-0164	A-41672-A15F102
16	41672-0123	A-41672-A16D501	41672-0142	A-41672-A16C501	026482169	A-41672-A16E102	41672-0165	A-41672-A16F102
17	41672-0124	A-41672-A17D501	41672-0143	A-41672-A17C501	026482179	A-41672-A17E102	41672-0166	A-41672-A17F102
18	41672-0125	A-41672-A18D501	41672-0144	A-41672-A18C501	026482189	A-41672-A18E102	41672-0167	A-41672-A18F102
19	41672-0126	A-41672-A19D501	41672-0145	A-41672-A19C501	026482199	A-41672-A19E102	41672-0168	A-41672-A19F102
20	41672-0127	A-41672-A20D501	41672-0146	A-41672-A20C501	026482209	A-41672-A20E102	41672-0169	A-41672-A20F102
21	41672-0128	A-41672-A21D501	41672-0147	A-41672-A21C501	026482219	A-41672-A21E102	41672-0170	A-41672-A21F102
22	41672-0129	A-41672-A22D501	41672-0148	A-41672-A22C501	026482229	A-41672-A22E102	41672-0171	A-41672-A22F102
23	41672-0130	A-41672-A23D501	41672-0149	A-41672-A23C501	026482239	A-41672-A23E102	41672-0172	A-41672-A23F102
24	026586242	A-41672-A24D501	41672-0150	A-41672-A24C501	026482249	A-41672-A24E102	41672-0173	A-41672-A24F102

REV: AB4	<u>ECR/ECN INFORMATION:</u>	<u>TITLE:</u> KK 156 HEADER ASSEMBLY FRICTION LOCK BREAKAWAY RIGHT ANGLE	<u>SHEET No.</u> - 4 -
	<u>EC No.:</u> UCP2009-2938		
	<u>DATE:</u> 6/15/2009		
<u>DOCUMENT NUMBER:</u> SD- 41672 -001	<u>CREATED / REVISED BY:</u> MKIPPER	<u>CHECKED BY:</u> SSOUSEK	<u>APPROVED BY:</u> FSMITH

Header No:	41186-A-AN
Pin No:	2161-52(102)
Pin Length L	1.063 / 27.00
Mating M	.450 / 11.43
Gold:	NA
Bend Height: Y	.213 / 5.41
PC Tail P	.172 / 4.69
Tin:	OVERALL
Pack Per	PK-41672-001

Header No:	41186-A-AN
Pin No:	2161-37(102)
Pin Length L	1.100 / 27.90
Mating M	.450 / 11.43
Gold:	NA
Bend Height: Y	.213 / 5.41
PC Tail P	.212 / 5.38
Tin:	OVERALL
Pack Per	PK-41672-001

Header No:	41186-A-AN
Pin No:	2161-37(501)
Pin Length L	1.100 / 27.90
Mating M	.450 / 11.43
Gold:	OVERALL
Bend Height: Y	.213 / 5.41
PC Tail P	.212 / 5.38
Tin:	NA
Pack Per	PK-41672-001

Ckts	Material No	Engineer Number
2	41672-0176	A-41672-A02G102
3	41672-0177	A-41672-A03G102
4	41672-0178	A-41672-A04G102
5	41672-0179	A-41672-A05G102
6	41672-0180	A-41672-A06G102
7	41672-0181	A-41672-A07G102
8	41672-0182	A-41672-A08G102
9	41672-0183	A-41672-A09G102
10	41672-0184	A-41672-A10G102
11	41672-0185	A-41672-A11G102
12	41672-0186	A-41672-A12G102
13	41672-0187	A-41672-A13G102
14	41672-0188	A-41672-A14G102
15	41672-0189	A-41672-A15G102
16	41672-0190	A-41672-A16G102
17	41672-0191	A-41672-A17G102
18	41672-0192	A-41672-A18G102
19	41672-0193	A-41672-A19G102
20	41672-0194	A-41672-A20G102
21	41672-0195	A-41672-A21G102
22	41672-0196	A-41672-A22G102
23	41672-0197	A-41672-A23G102
24	41672-0198	A-41672-A24G102

Material No	Engineer Number	Void
026504051	A-41672-A05A102-51	2,4
41672-0047	A-41672-A02A102-1	1
41672-0174	A-41672-A23A102-51	18,20 .22
026504042	A-41672-A04A102-02	2
026504061	A-41672-A06A102-4	4
026504043	A-41672-A04A102-3	3
026504062	A-41672-A06A102-5	5
416720048	A-41672-A09A102-51	2,3,4, 6,7,8
416720049	A-41672-A14A102-12	12
026504102	A-41672-A10A102-5	5
026504072	A-41672-A07A102-2	2
41672-0175	A-41672-A11A102-2	2
41672-0203	A-41672-A14A102-51	2,6, 11,13
41672-0227	A-41672-A05A102-2	2

Material No	Engineer Number	Void
026504121	A-41672-A12A501-51	4,6
026497063	A-41672-A06A501-5	5

REV: AB4	<u>ECR/ECN INFORMATION:</u>	<u>TITLE:</u> KK 156 HEADER ASSEMBLY FRICTION LOCK BREAKAWAY RIGHT ANGLE	<u>SHEET No.</u> - 5 -	
	<u>EC No.:</u> UCP2009-2938			
	<u>DATE:</u> 6/15/2009			
<u>DOCUMENT NUMBER:</u> SD- 41672 -001		<u>CREATED / REVISED BY:</u> MKIPPER	<u>CHECKED BY:</u> SSOUSEK	<u>APPROVED BY:</u> FSMITH

6

5

4

3

2

1

CENTERLINE OF PIN IN AREA SHOWN NOT TO VARY FROM CENTERLINE OF PIN AT -D- BY MORE THAN 0.13/.005 IN ANY DIRECTION.

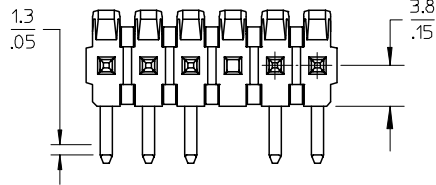

A-41681- * N * * * *
 OPTION - PACKING
 A=BRASS - BULK PACK
 B=BRASS - TUBE PACK
 NO OF CKTS
 DIM M.L.P
 PLATING
 VOID LOCATIONS
 BLANK=NO VOIDS
 NO=CKT NO VOIDED
 MULT-VOIDS=51 UP

CENTERLINE OF PIN IN AREA SHOWN NOT TO VARY FROM CENTERLINE OF PIN AT -D- BY MORE THAN 0.20/.008 IN ANY DIRECTION.

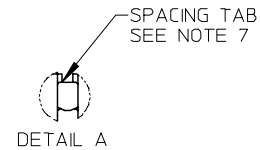

OPTIONAL VOIDED CKT. SEE CHART FOR LOCATIONS

NOTES:

- MATERIAL: HEADER: POLYESTER, 94V-0, MOLDED BLACK
- FINISH:
 (228) SELECT GOLD: 0.00076/.000030 MIN.
 *SELECT TIN: 0.00254/.000100 MIN.
 OVERALL NICKEL UNDERPLATE: 0.00127/.000050 MIN.
 *THE PRIMARY SHIPPING CARTON WILL BE LABELED "COMPLIANT TO ROHS DIRECTIVE 2002/95/EC AND ELV ANNEX II OF DIRECTIVE 2000/53/EC". CARTONS WITHOUT THIS LABEL MAY CONTAIN PRODUCT WITH TIN/LEAD PLATINGS.
- PRODUCT SPECIFICATION: PS-08-50.
- PACKAGING INFORMATION: SEE CHARTS
- SOLDERABILITY: PER SMES-152.
- PIN PUSH-OUT FORCE: PRIOR TO SOLDERING, A 3 LB. MINIMUM FORCE IN EITHER DIRECTION SHALL BE REQUIRED TO PUSH THE PIN OUT OF THE HEADER.
- PARTS ARE STACKABLE END TO END ON 3.96/.156 CENTERS.(SPACING TABS MUST BE REMOVED ON CIRCUIT SIZES 1-23 BEFORE PARTS ARE STACKABLE.

CIRCUIT	A	B
2	6.78/7.87 .267/.310	3.96 .156
3	10.74/11.84 .423/.466	7.92 .312
4	14.71/15.80 .579/.622	11.89 .468
5	18.67/19.76 .735/.778	15.85 .624
6	22.63/23.72 .891/.934	19.81 .780
7	26.59/27.69 1.047/1.090	23.77 .936
8	30.56/31.65 1.203/1.246	27.74 1.092
9	34.52/35.61 1.359/1.402	31.70 1.248
10	38.48/39.57 1.515/1.558	35.66 1.404
11	42.44/43.54 1.671/1.714	39.62 1.560
12	46.41/47.50 1.827/1.870	43.59 1.716
13	50.37/51.46 1.983/2.026	47.55 1.872
14	54.33/55.42 2.139/2.182	51.51 2.028
15	58.29/59.39 2.295/2.338	55.47 2.184
16	62.26/63.35 2.451/2.494	59.44 2.340
17	66.22/67.31 2.607/2.650	63.40 2.496
18	70.18/71.27 2.763/2.806	67.36 2.652
19	74.14/75.23 2.919/2.962	71.32 2.808
20	78.11/79.20 3.075/3.118	75.29 2.964
21	82.07/83.16 3.231/3.274	79.25 3.120
22	86.03/87.12 3.387/3.430	83.21 3.276
23	89.94/91.08 3.541/3.586	87.17 3.432
24	93.85/95.00 3.695/3.740	91.14 3.588

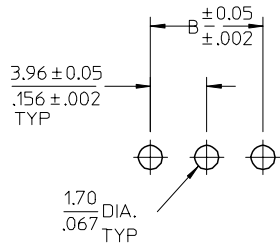

PCB LAYOUT: COMPONENT SIDE
 RECOMMENDED PCB THICKNESS:
 (1.57 ± .18) / .062 ± .007

ADD DIMENSION	EC NO: UCP2006-2296	DESCRIPTION
	DRWN: PRIDDER 2006/04/27	
	CHKD: ADERR 2006/04/28	
	APPR: FSMITH 2006/04/28	
REV	A2	

QUALITY SYMBOLS	GENERAL TOLERANCES (UNLESS SPECIFIED)
▽=0	mm INCH
▽=0	4 PLACES ± --- ± ---
	3 PLACES ± --- ± .010
	2 PLACES ± 0.25 ± .015
	1 PLACE ± 0.38 ± ---
	ANGULAR ± 1/2°

DRAWN BY	DATE	
	JSCHAFER	12-5-03
CHECKED BY	DATE	
	KSAMIEC	12-12-03
APPROVED BY	DATE	
	MARGULIS	12-16-03
MATERIAL NO.	SEE CHART	
SIZE	THIS DRAWING CONTAINS INFORMATION THAT IS PROPRIETARY TO MOLEX INCORPORATED AND SHOULD NOT BE USED WITHOUT WRITTEN PERMISSION	

DIMENSION STYLE	SCALE	DESIGN UNITS	THIRD ANGLE PROJECTION
MM/IN	2:1	INCH	☉
TITLE			
KK .156 HEADER ASSEMBLY FRICTION LOCK BREAKAWAY RIGHT ANGLE (LEAD-FREE)			
MATERIAL NO. DOCUMENT NO. SHEET NO.			
SEE CHART		SD-41672-002	1 OF *

MATERIAL NO. DOCUMENT NO. SHEET NO.			
SEE CHART		SD-41672-002	1 OF *
THIS DRAWING CONTAINS INFORMATION THAT IS PROPRIETARY TO MOLEX INCORPORATED AND SHOULD NOT BE USED WITHOUT WRITTEN PERMISSION			

5

4

3

2

1

