

Technische Information / Technical Information

IGBT-Module
IGBT-Modules

FZ 800 R 12 KL4C

eupec

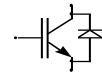

vorläufige Daten
preliminary data

Höchstzulässige Werte / Maximum rated values

Elektrische Eigenschaften / Electrical properties

Kollektor-Emitter-Sperrspannung collector-emitter voltage		V_{CES}	1200	V
Kollektor-Dauergleichstrom DC-collector current	$T_C = 80^\circ\text{C}$	$I_{C,nom.}$	800	A
	$T_C = 25^\circ\text{C}$	I_C	1300	A
Periodischer Kollektor Spitzenstrom repetitive peak collector current	$t_p = 1\text{ ms}, T_C = 80^\circ\text{C}$	I_{CRM}	1600	A
Gesamt-Verlustleistung total power dissipation	$T_C = 25^\circ\text{C}$, Transistor	P_{tot}	5,6	kW
Gate-Emitter-Spitzenspannung gate-emitter peak voltage		V_{GES}	+/- 20V	V
Dauergleichstrom DC forward current		I_F	800	A
Periodischer Spitzenstrom repetitive peak forw. current	$t_p = 1\text{ ms}$	I_{FRM}	1600	A
Grenzlastintegral der Diode I^2t - value, Diode	$V_R = 0\text{V}, t_p = 10\text{ms}, T_{vj} = 125^\circ\text{C}$	I^2t	240	kA^2s
Isolations-Prüfspannung insulation test voltage	RMS, $f = 50\text{ Hz}, t = 1\text{ min.}$	V_{ISOL}	2,5	kV

Charakteristische Werte / Characteristic values

Transistor / Transistor

			min.	typ.	max.	
Kollektor-Emitter Sättigungsspannung collector-emitter saturation voltage	$I_C = 800\text{A}, V_{GE} = 15\text{V}, T_{vj} = 25^\circ\text{C}$	$V_{CE\text{ sat}}$	-	2,1	2,6	V
	$I_C = 800\text{A}, V_{GE} = 15\text{V}, T_{vj} = 125^\circ\text{C}$		-	2,4		V
Gate-Schwellenspannung gate threshold voltage	$I_C = 32\text{mA}, V_{CE} = V_{GE}, T_{vj} = 25^\circ\text{C}$	$V_{GE(th)}$	4,5	5,5	6,5	V
Eingangskapazität input capacitance	$f = 1\text{MHz}, T_{vj} = 25^\circ\text{C}, V_{CE} = 25\text{V}, V_{GE} = 0\text{V}$	C_{ies}	-	56	-	nF
Kollektor-Emitter Reststrom collector-emitter cut-off current	$V_{CE} = 1200\text{V}, V_{GE} = 0\text{V}, T_{vj} = 25^\circ\text{C}$	I_{CES}	-	0,02	1	mA
	$V_{CE} = 1200\text{V}, V_{GE} = 0\text{V}, T_{vj} = 125^\circ\text{C}$		-	1		mA
Gate-Emitter Reststrom gate-emitter leakage current	$V_{CE} = 0\text{V}, V_{GE} = 20\text{V}, T_{vj} = 25^\circ\text{C}$	I_{GES}	-	-	600	nA

prepared by: Mark Münzer

date of publication: 14.8.1998

approved by: Hubert Ludwig

revision: 1c

Technische Information / Technical Information

IGBT-Module
IGBT-Modules

FZ 800 R 12 KL4C

eupec

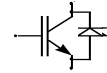

vorläufige Daten
preliminary data

Charakteristische Werte / Characteristic values

Transistor / Transistor			min.	typ.	max.	
Einschaltverzögerungszeit (ind. Last) turn on delay time (inductive load)	$I_C = 800A, V_{CE} = 600V$	$t_{d,on}$	-	0,27	-	μs
	$V_{GE} = \pm 15V, R_G = 1,8\Omega, T_{vj} = 25^\circ C$					
	$V_{GE} = \pm 15V, R_G = 1,8\Omega, T_{vj} = 125^\circ C$					
Anstiegszeit (induktive Last) rise time (inductive load)	$I_C = 800A, V_{CE} = 600V$	t_r	-	0,15	-	μs
	$V_{GE} = \pm 15V, R_G = 1,8\Omega, T_{vj} = 25^\circ C$					
	$V_{GE} = \pm 15V, R_G = 1,8\Omega, T_{vj} = 125^\circ C$					
Abschaltverzögerungszeit (ind. Last) turn off delay time (inductive load)	$I_C = 800A, V_{CE} = 600V$	$t_{d,off}$	-	0,9	-	μs
	$V_{GE} = \pm 15V, R_G = 1,8\Omega, T_{vj} = 25^\circ C$					
	$V_{GE} = \pm 15V, R_G = 1,8\Omega, T_{vj} = 125^\circ C$					
Fallzeit (induktive Last) fall time (inductive load)	$I_C = 800A, V_{CE} = 600V$	t_f	-	0,09	-	μs
	$V_{GE} = \pm 15V, R_G = 1,8\Omega, T_{vj} = 25^\circ C$					
	$V_{GE} = \pm 15V, R_G = 1,8\Omega, T_{vj} = 125^\circ C$					
Einschaltverlustenergie pro Puls turn-on energy loss per pulse	$I_C = 800A, V_{CE} = 600V, V_{GE} = 15V$ $R_G = 1,8\Omega, T_{vj} = 125^\circ C, L_S = 70nH$	E_{on}	-	121	-	mWs
Abschaltverlustenergie pro Puls turn-off energy loss per pulse	$I_C = 800A, V_{CE} = 600V, V_{GE} = 15V$ $R_G = 1,8\Omega, T_{vj} = 125^\circ C, L_S = 70nH$	E_{off}	-	127	-	mWs
Kurzschlußverhalten SC Data	$t_p \leq 10\mu sec, V_{GE} \leq 15V, R_G = 1,8\Omega$ $T_{vj} \leq 125^\circ C, V_{CC} = 900V, V_{CEmax} = V_{CES} - L_{sCE} \cdot di/dt$	I_{SC}	-	6000	-	A
Modulinduktivität stray inductance module		L_{sCE}	-	15	-	nH
Modul Leitungswiderstand, Anschlüsse – Chip module lead resistance, terminals – chip	$T_C = 25^\circ C$	R_{CC+EE}	-	0,10	-	m Ω

Charakteristische Werte / Characteristic values

Diode / Diode			min.	typ.	max.	
Durchlaßspannung forward voltage	$I_F = 800A, V_{GE} = 0V, T_{vj} = 25^\circ C$	V_F	-	1,8	2,3	V
	$I_F = 800A, V_{GE} = 0V, T_{vj} = 125^\circ C$					
Rückstromspitze peak reverse recovery current	$I_F = 800A, -di_F/dt = 5700A/\mu sec$	I_{RM}	-	552	-	A
	$V_R = 600V, V_{GE} = -15V, T_{vj} = 25^\circ C$					
	$V_R = 600V, V_{GE} = -15V, T_{vj} = 125^\circ C$					
Sperrverzögerungsladung recovered charge	$I_F = 800A, -di_F/dt = 5700A/\mu sec$	Q_r	-	74	-	μAs
	$V_R = 600V, V_{GE} = -15V, T_{vj} = 25^\circ C$					
	$V_R = 600V, V_{GE} = -15V, T_{vj} = 125^\circ C$					
Abschaltenergie pro Puls reverse recovery energy	$I_F = 800A, -di_F/dt = 5700A/\mu sec$	E_{rec}	-	24	-	mWs
	$V_R = 600V, V_{GE} = -15V, T_{vj} = 25^\circ C$					
	$V_R = 600V, V_{GE} = -15V, T_{vj} = 125^\circ C$					

Technische Information / Technical Information

IGBT-Module
IGBT-Modules

FZ 800 R 12 KL4C

eupec

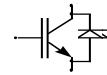

vorläufige Daten
preliminary data

Thermische Eigenschaften / Thermal properties

			min.	typ.	max.	
Innerer Wärmewiderstand thermal resistance, junction to case	Transistor / transistor, DC	R_{thJC}	-	-	0,022	K/W
	Diode/Diode, DC		-	-	0,04	K/W
Übergangs-Wärmewiderstand thermal resistance, case to heatsink	pro Modul / per module $d_{paste} \leq 100\mu m / d_{grease} \leq 100\mu m$	R_{thCK}	-	-	0,01	K/W
Höchstzulässige Sperrschichttemperatur maximum junction temperature		T_{vj}	-	-	150	°C
Betriebstemperatur operation temperature		T_{op}	-40	-	125	°C
Lagertemperatur storage temperature		T_{stg}	-40	-	125	°C

Mechanische Eigenschaften / Mechanical properties

Gehäuse, siehe Anlage case, see appendix						
Innere Isolation internal insulation				AL ₂ O ₃		
Kriechstrecke creepage distance				17		mm
Luftstrecke clearance				10		mm
CTI comperative tracking index				275		
Anzugsdrehmoment f. mech. Befestigung mounting torque		M1	4,25	5	5,75	Nm
Anzugsdrehmoment f. elektr. Anschlüsse terminal connection torque	terminals M4	M2	1,7	2	2,3	Nm
	terminals M8		8		10	Nm
Gewicht weight		G		1500		g

Mit dieser technischen Information werden Halbleiterbauelemente spezifiziert, jedoch keine Eigenschaften zugesichert. Sie gilt in Verbindung mit den zugehörigen Technischen Erläuterungen.

This technical information specifies semiconductor devices but promises no characteristics. It is valid in combination with the belonging technical notes.

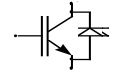

Ausgangskennlinie (typisch)
Output characteristic (typical)

$I_C = f(V_{CE})$
 $V_{GE} = 15V$

vorläufige Daten
preliminary data

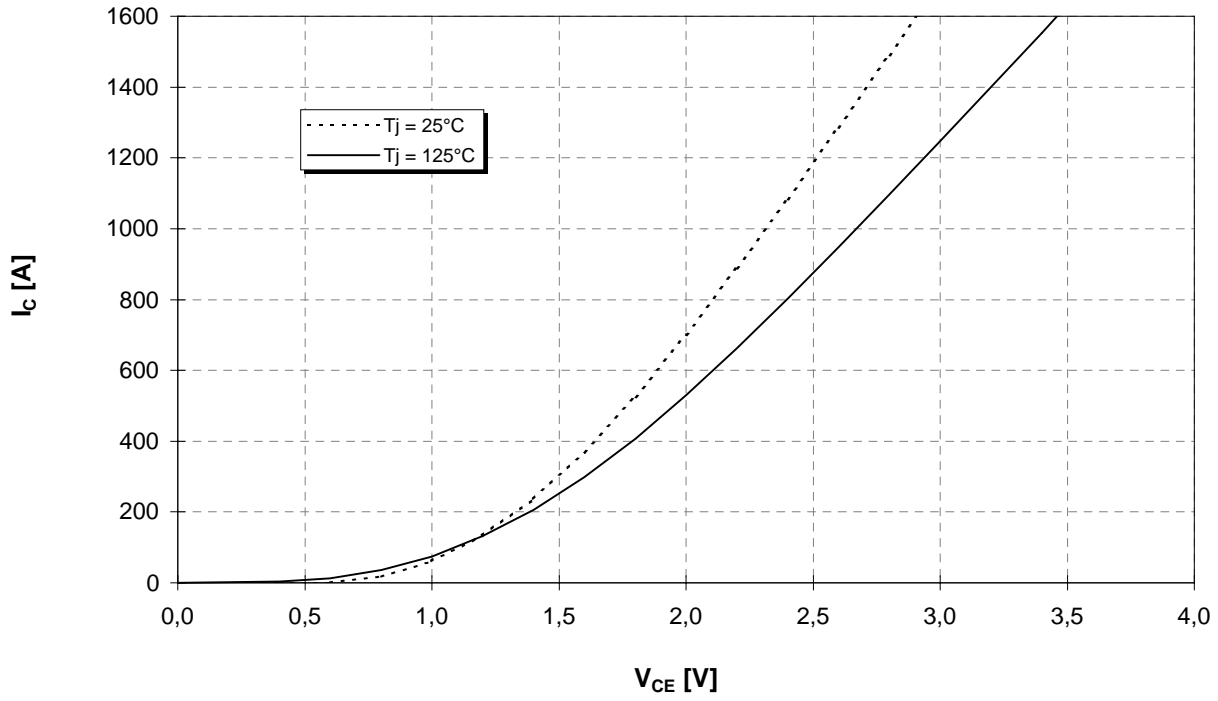

Ausgangskennlinienfeld (typisch)
Output characteristic (typical)

$I_C = f(V_{CE})$
 $T_{vj} = 125°C$

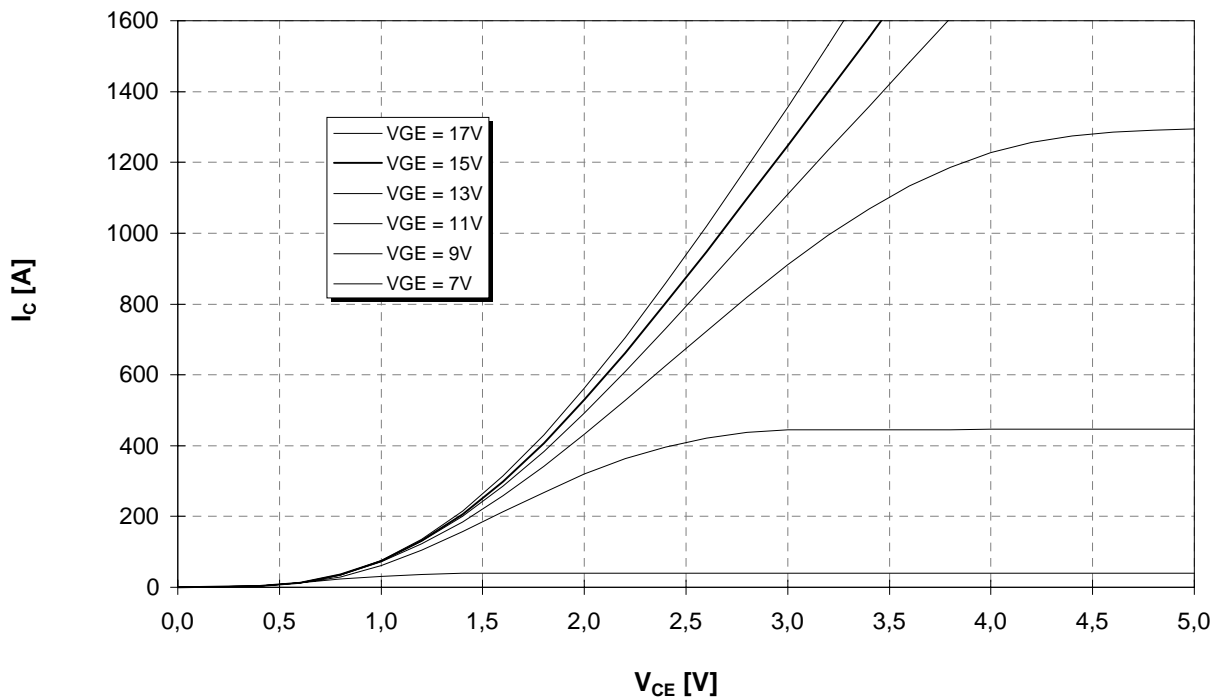

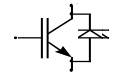

vorläufige Daten
preliminary data

Übertragungscharakteristik (typisch)
Transfer characteristic (typical)

$I_C = f(V_{GE})$
 $V_{CE} = 20V$

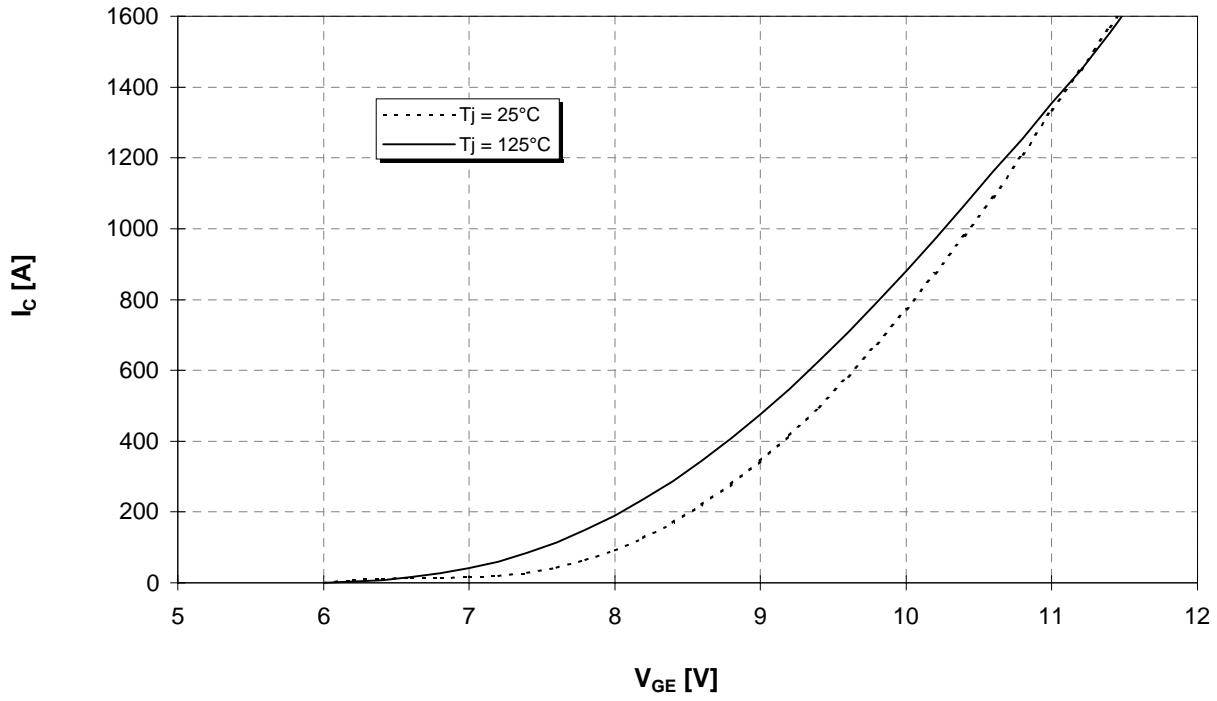

Durchlaßkennlinie der Inversdiode (typisch)
Forward characteristic of inverse diode (typical)

$I_F = f(V_F)$

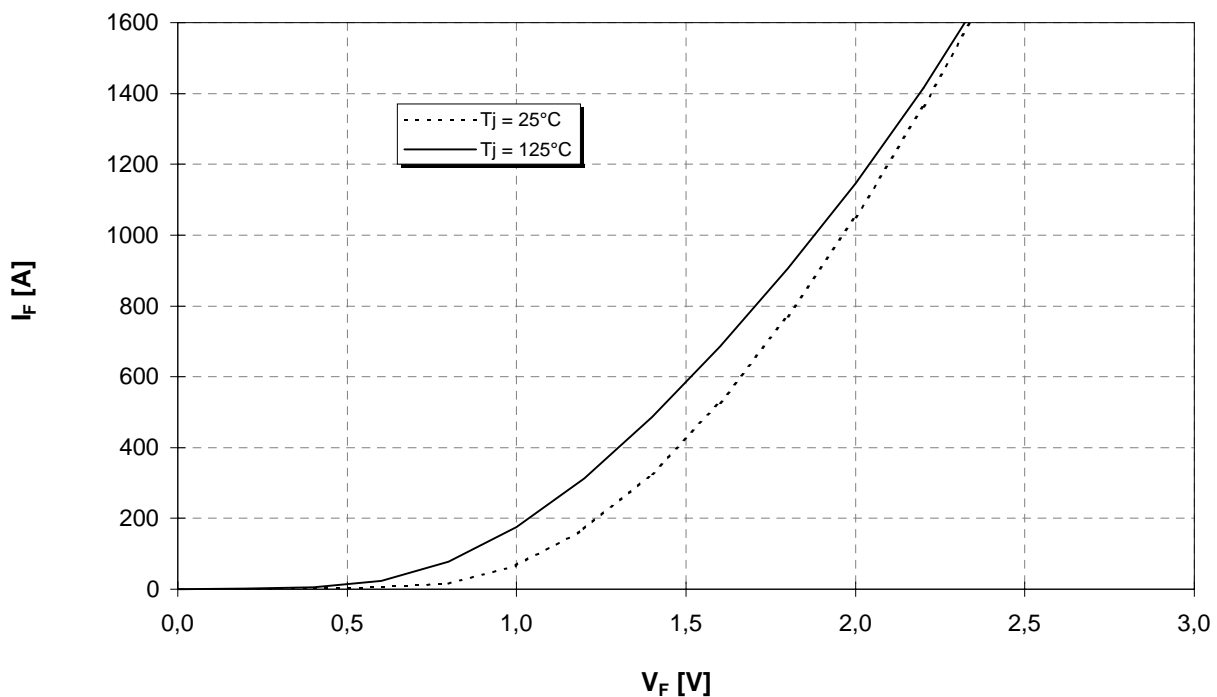

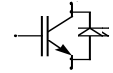

vorläufige Daten
preliminary data

Schaltverluste (typisch) $E_{on} = f(I_C)$, $E_{off} = f(I_C)$, $E_{rec} = f(I_C)$
Switching losses (typical) $R_{gon} = R_{goff} = 1,8 \Omega$, $V_{CE} = 600V$, $T_j = 125^\circ C$

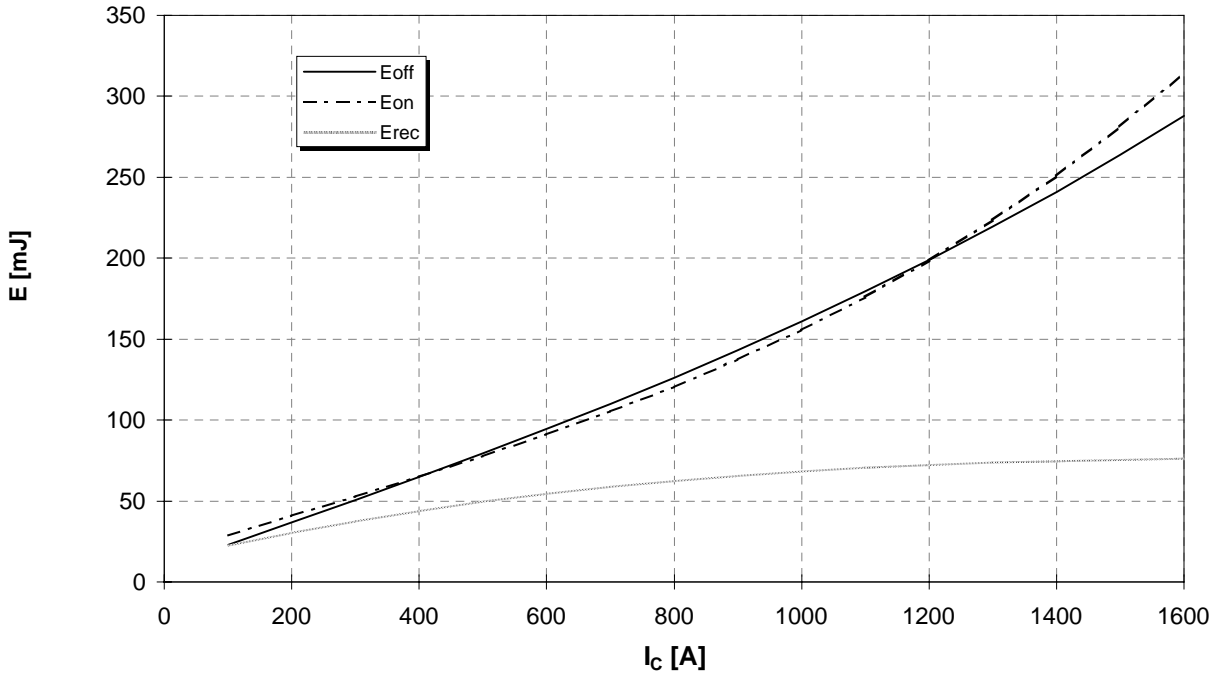

Schaltverluste (typisch) $E_{on} = f(R_G)$, $E_{off} = f(R_G)$, $E_{rec} = f(R_G)$
Switching losses (typical) $I_C = 800A$, $V_{CE} = 600V$, $T_j = 125^\circ C$

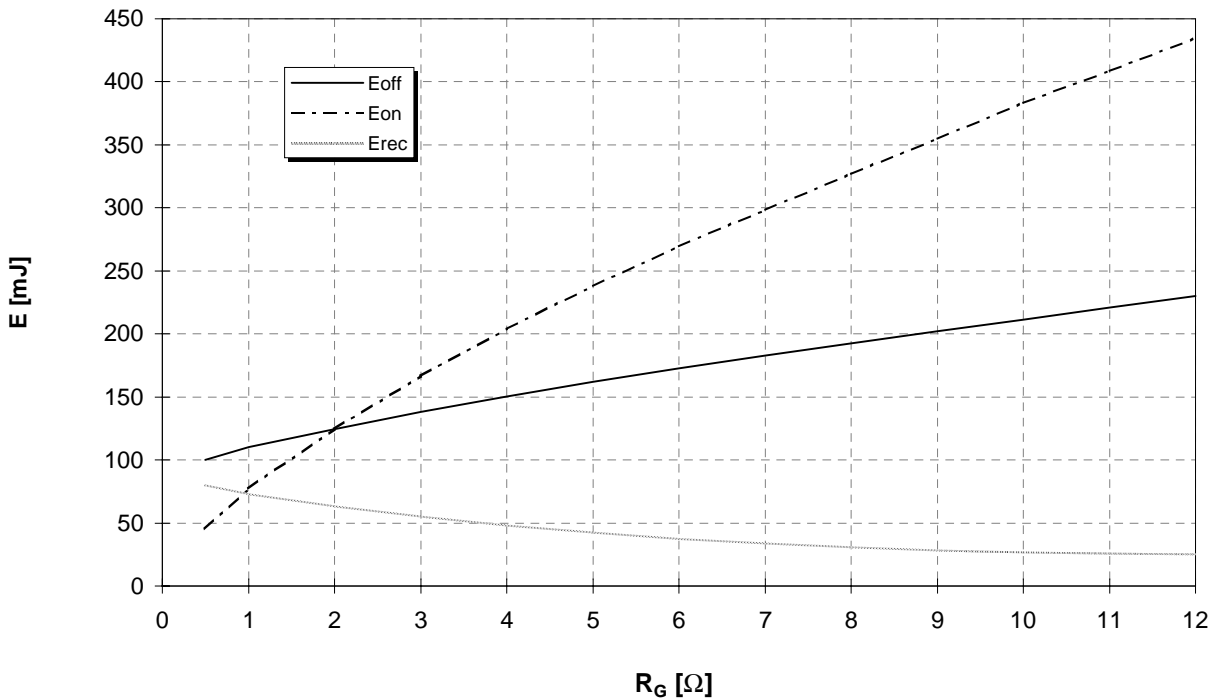

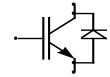

vorläufige Daten
preliminary data

Transienter Wärmewiderstand
Transient thermal impedance

$$Z_{thJC} = f(t)$$

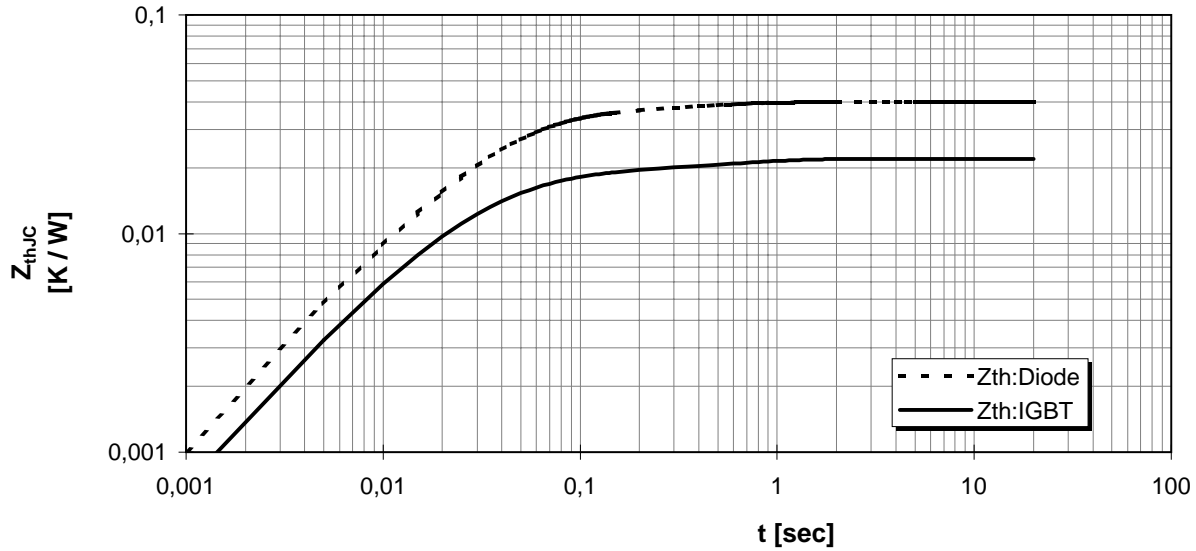

i	1	2	3	4
r_i [K/kW] : IGBT	9,08	4,9	4,56	3,45
τ_i [sec] : IGBT	0,018	0,036	0,051	0,522
r_i [K/kW] : Diode	18,39	6,09	9,78	5,71
τ_i [sec] : Diode	0,029	0,04	0,045	0,331

Sicherer Arbeitsbereich (RBSOA)

Reverse bias safe operation area (RBSOA)

$R_g = 1,80\Omega$, $T_v = 125^\circ\text{C}$

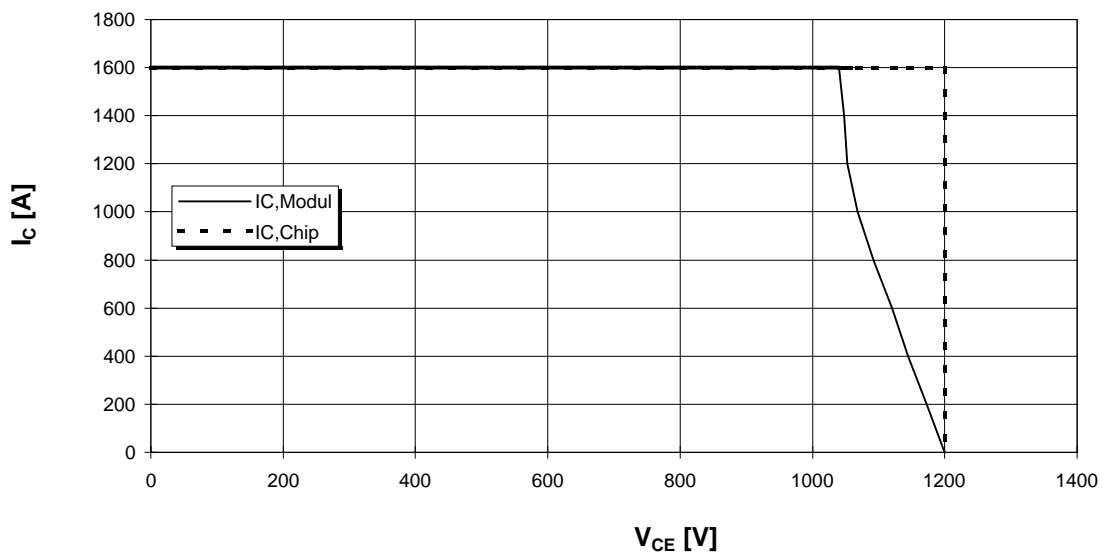

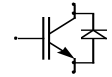

preliminary data

vorläufige Daten

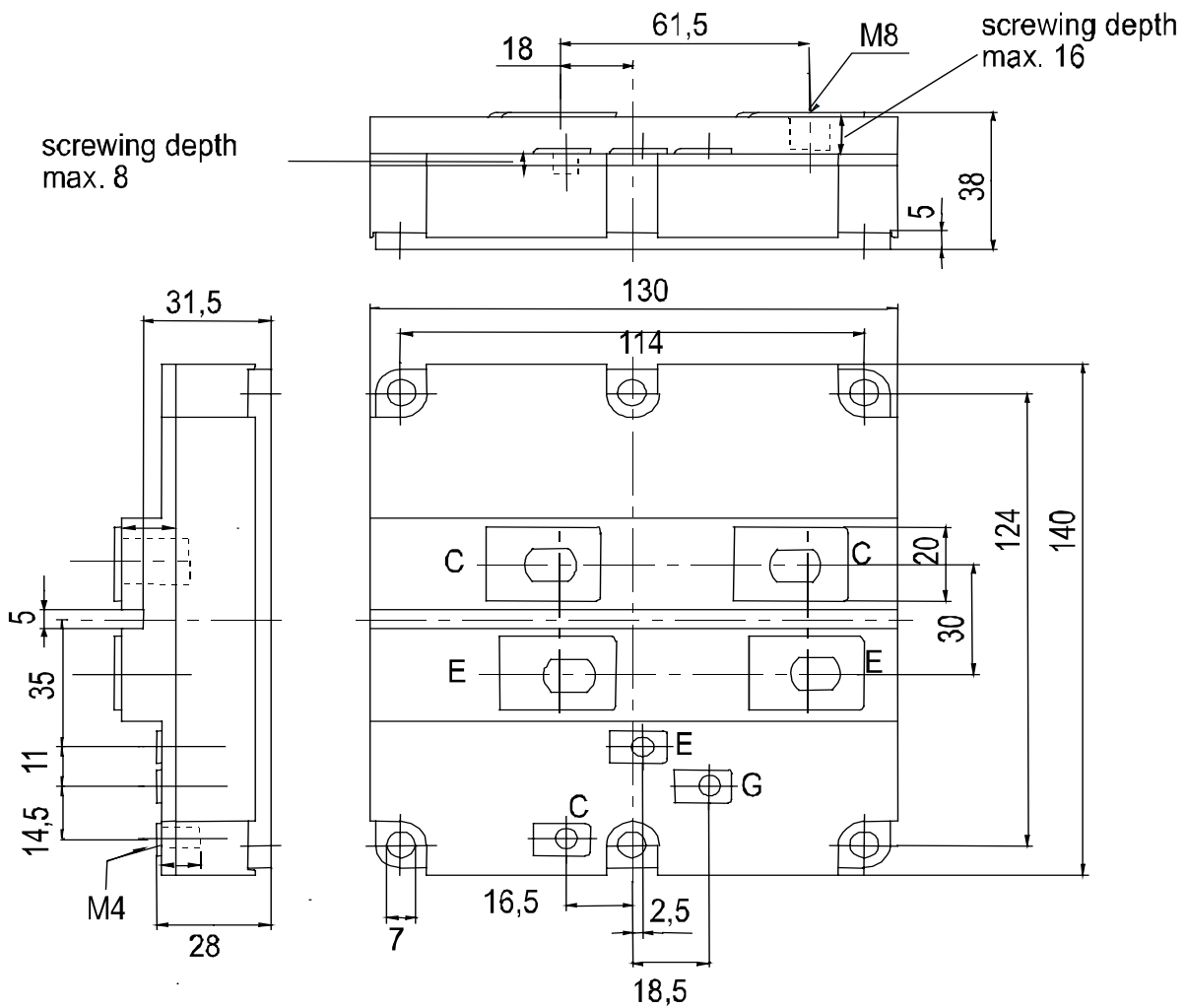

external connections (to be done)

