

Surface Mountable Input Rectifier Diode, 8 A

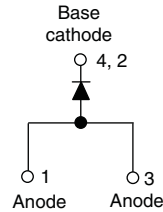

D-PAK



DESCRIPTION/FEATURES

The 8EWS..SPbF rectifier High Voltage Series has been optimized for very low forward voltage drop, with moderate leakage. The glass passivation technology used has reliable operation up to 150 °C junction temperature.



The **high reverse voltage** range available allows design of input stage primary rectification with **outstanding voltage surge** capability.

Typical applications are in input rectification and these products are designed to be used with Vishay HPP switches and output rectifiers which are available in identical package outlines.

This product has been designed and qualified for industrial level.

Compliant to RoHS directive 2002/95/EC.

| PRODUCT SUMMARY | |
|-----------------|------------|
| V_F at 5 A | 1 V |
| I_{FSM} | 200 A |
| V_{RRM} | 800/1200 V |

| OUTPUT CURRENT IN TYPICAL APPLICATIONS | | | |
|---|---------------------|--------------------|-------|
| APPLICATIONS | SINGLE-PHASE BRIDGE | THREE-PHASE BRIDGE | UNITS |
| NEMA FR-4 or G10 glass fabric-based epoxy with 4 oz. (140 μ m) copper | 1.2 | 1.6 | A |
| Aluminum IMS, $R_{thCA} = 15$ °C/W | 2.5 | 2.8 | |
| Aluminum IMS with heatsink, $R_{thCA} = 5$ °C/W | 5.5 | 6.5 | |

Note

- $T_A = 55$ °C, $T_J = 125$ °C, footprint 300 mm²

| MAJOR RATINGS AND CHARACTERISTICS | | | |
|-----------------------------------|---------------------|-------------|-------|
| SYMBOL | CHARACTERISTICS | VALUES | UNITS |
| $I_{F(AV)}$ | Sinusoidal waveform | 8 | A |
| V_{RRM} | | 800/1200 | V |
| I_{FSM} | | 200 | A |
| V_F | 8 A, $T_J = 25$ °C | 1.10 | V |
| T_J | | - 55 to 150 | °C |

| VOLTAGE RATINGS | | | |
|-----------------|---|--|---------------------------|
| PART NUMBER | V_{RRM} , MAXIMUM PEAK REVERSE VOLTAGE V | V_{RSM} , MAXIMUM NON-REPETITIVE PEAK REVERSE VOLTAGE V | I_{RRM} AT 150 °C mA |
| 8EWS08SPbF | 800 | 900 | 0.5 |
| 8EWS12SPbF | 1200 | 1300 | |

8EWS..SPbF High Voltage Series



Vishay High Power Products Surface Mountable
Input Rectifier Diode, 8 A

| ABSOLUTE MAXIMUM RATINGS | | | | |
|---|---------------|--|--------|-------------------|
| PARAMETER | SYMBOL | TEST CONDITIONS | VALUES | UNITS |
| Maximum average forward current | $I_{F(AV)}$ | $T_C = 105\text{ }^\circ\text{C}$, 180° conduction half sine wave | 8 | A |
| Maximum peak one cycle non-repetitive surge current | I_{FSM} | 10 ms sine pulse, rated V_{RRM} applied | 170 | |
| | | 10 ms sine pulse, no voltage reapplied | 200 | |
| Maximum I^2t for fusing | I^2t | 10 ms sine pulse, rated V_{RRM} applied | 130 | A ² s |
| | | 10 ms sine pulse, no voltage reapplied | 145 | |
| Maximum $I^2\sqrt{t}$ for fusing | $I^2\sqrt{t}$ | $t = 0.1\text{ ms to }10\text{ ms}$, no voltage reapplied | 1450 | A ² √s |

| ELECTRICAL SPECIFICATIONS | | | | |
|---------------------------------|-------------|---------------------------------------|--------|-------|
| PARAMETER | SYMBOL | TEST CONDITIONS | VALUES | UNITS |
| Maximum forward voltage drop | V_{FM} | 8 A, $T_J = 25\text{ }^\circ\text{C}$ | 1.1 | V |
| Forward slope resistance | r_t | $T_J = 150\text{ }^\circ\text{C}$ | 20 | mΩ |
| Threshold voltage | $V_{F(TO)}$ | | 0.82 | V |
| Maximum reverse leakage current | I_{RM} | $T_J = 25\text{ }^\circ\text{C}$ | 0.05 | mA |
| | | $T_J = 150\text{ }^\circ\text{C}$ | | |

| THERMAL - MECHANICAL SPECIFICATIONS | | | | |
|---|------------------|-----------------------------|-----------------------|-------|
| PARAMETER | SYMBOL | TEST CONDITIONS | VALUES | UNITS |
| Maximum junction and storage temperature range | T_J, T_{Stg} | | - 55 to 150 | °C |
| | | | Soldering temperature | |
| Maximum thermal resistance, junction to case | R_{thJC} | DC operation | 2.5 | °C/W |
| Typical thermal resistance, junction to ambient (PCB mount) | $R_{thJA}^{(1)}$ | | 62 | |
| Approximate weight | | | 1 | g |
| | | | 0.03 | oz. |
| Marking device | | Case style D-PAK (TO-252AA) | 8EWS12S | |

Note

⁽¹⁾ When mounted on 1" square (650 mm²) PCB of FR-4 or G-10 material 4 oz. (140 μm) copper 40 °C/W
For recommended footprint and soldering techniques refer to application note #AN-994



8EWS..SPbF High Voltage Series

Surface Mountable Vishay High Power Products
Input Rectifier Diode, 8 A

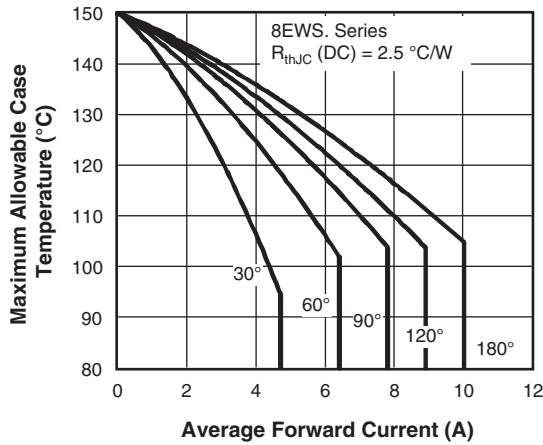

Fig. 1 - Current Rating Characteristics

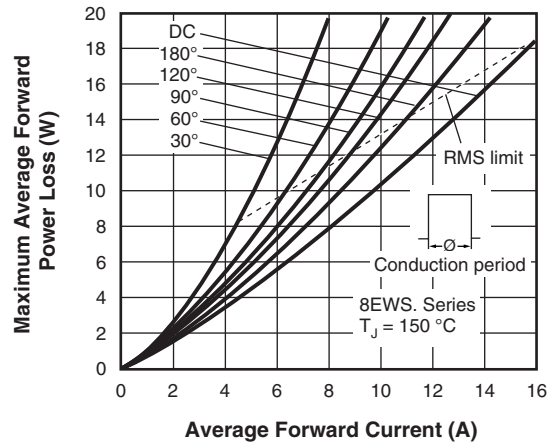

Fig. 4 - Forward Power Loss Characteristics

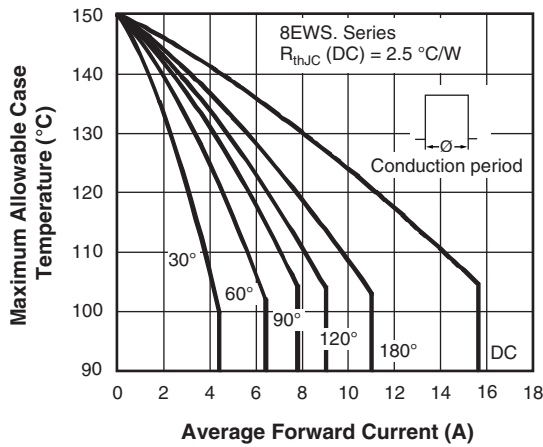

Fig. 2 - Current Rating Characteristics

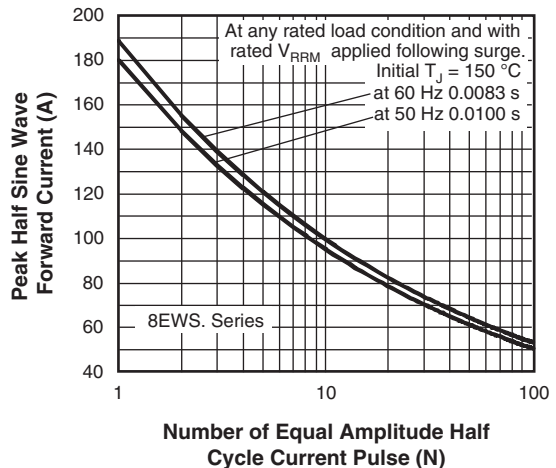

Fig. 5 - Maximum Non-Repetitive Surge Current

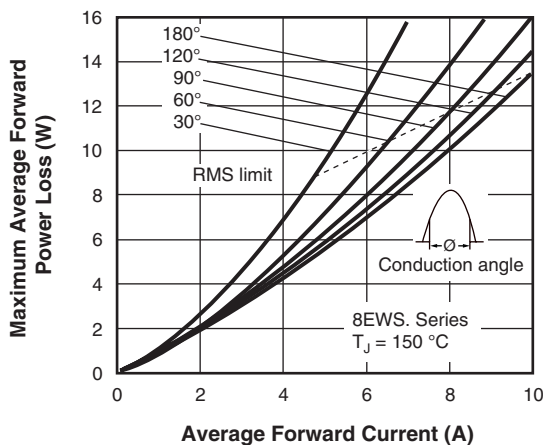

Fig. 3 - Forward Power Loss Characteristics

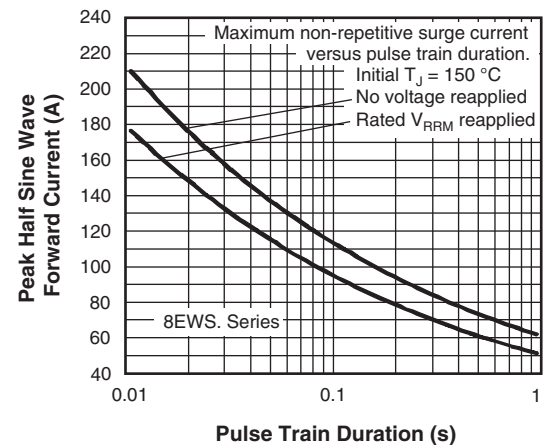

Fig. 6 - Maximum Non-Repetitive Surge Current

8EWS..SPbF High Voltage Series



Vishay High Power Products Surface Mountable
Input Rectifier Diode, 8 A

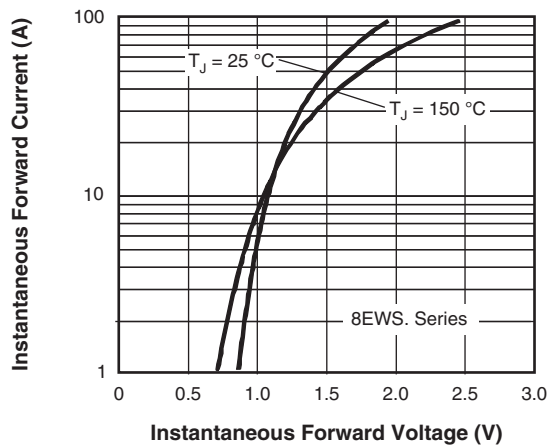

Fig. 7 - Forward Voltage Drop Characteristics

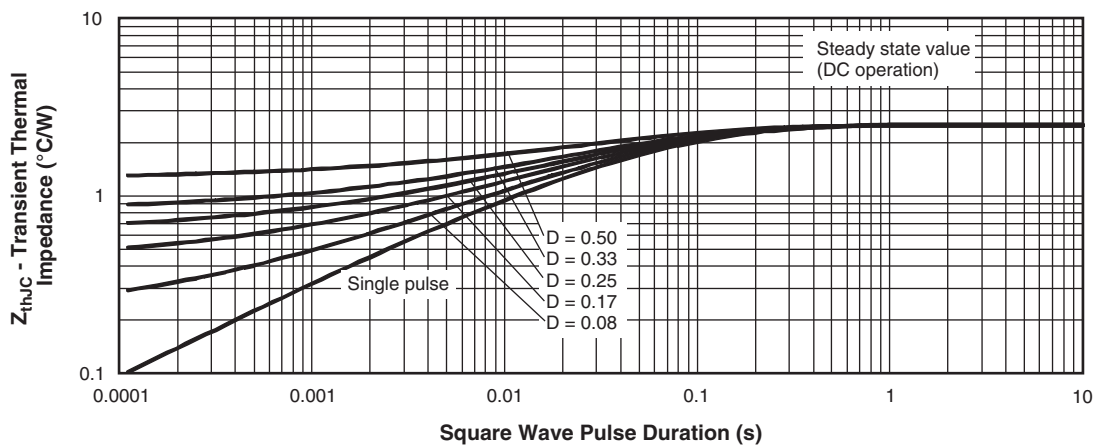

Fig. 8 - Thermal Impedance Z_{thJC} Characteristics



8EWS..SPbF High Voltage Series

Surface Mountable Vishay High Power Products
Input Rectifier Diode, 8 A

ORDERING INFORMATION TABLE

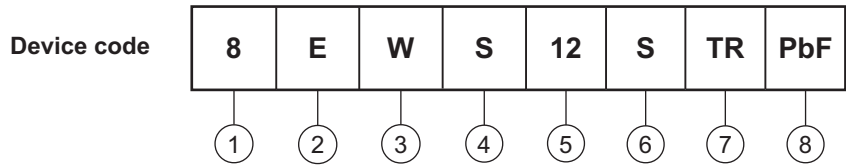

- 1** - Current rating (8 = 8 A)
- 2** - Circuit configuration:
E = Single diode
- 3** - Package:
W = D-PAK
- 4** - Type of silicon:
S = Standard recovery rectifier
- 5** - Voltage ratings 08 = 800 V
12 = 1200 V
- 6** - S = Surface mountable
- 7** -
 - TR = Tape and reel
 - TRR = Tape and reel (right oriented)
 - TRL = Tape and reel (left oriented)
- 8** - PbF = Lead (Pb)-free

| LINKS TO RELATED DOCUMENTS | |
|----------------------------|--|
| Dimensions | www.vishay.com/doc?95016 |
| Part marking information | www.vishay.com/doc?95059 |
| Packaging information | www.vishay.com/doc?95033 |

D-PAK (TO-252AA)

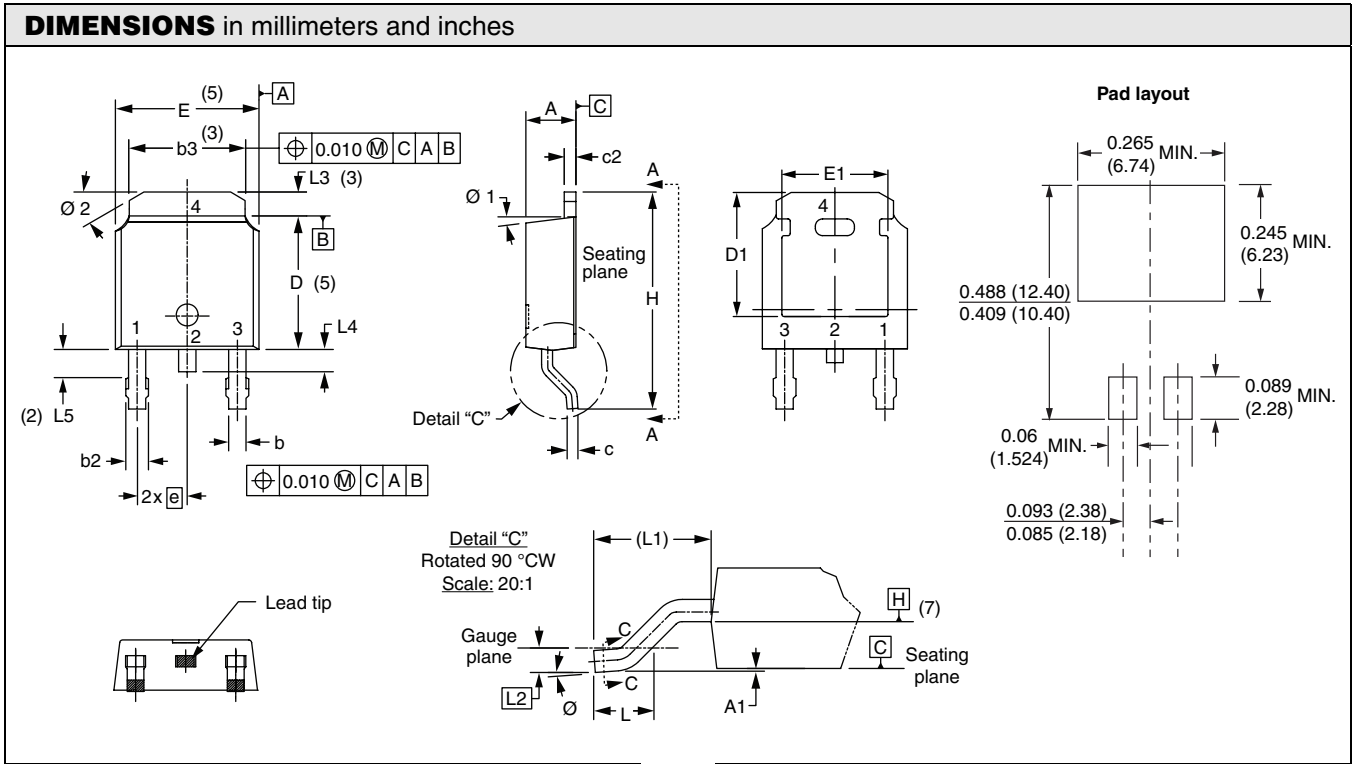

| SYMBOL | MILLIMETERS | | INCHES | | NOTES |
|--------|-------------|------|--------|-------|-------|
| | MIN. | MAX. | MIN. | MAX. | |
| A | 2.18 | 2.39 | 0.086 | 0.094 | |
| A1 | - | 0.13 | - | 0.005 | |
| b | 0.64 | 0.89 | 0.025 | 0.035 | |
| b2 | 0.76 | 1.14 | 0.030 | 0.045 | |
| b3 | 4.95 | 5.46 | 0.195 | 0.215 | 3 |
| c | 0.46 | 0.61 | 0.018 | 0.024 | |
| c2 | 0.46 | 0.89 | 0.018 | 0.035 | |
| D | 5.97 | 6.22 | 0.235 | 0.245 | 5 |
| D1 | 5.21 | - | 0.205 | - | 3 |
| E | 6.35 | 6.73 | 0.250 | 0.265 | 5 |
| E1 | 4.32 | - | 0.170 | - | 3 |

| SYMBOL | MILLIMETERS | | INCHES | | NOTES |
|--------|-------------|-------|------------|-------|-------|
| | MIN. | MAX. | MIN. | MAX. | |
| e | 2.29 BSC | | 0.090 BSC | | |
| H | 9.40 | 10.41 | 0.370 | 0.410 | |
| L | 1.40 | 1.78 | 0.055 | 0.070 | |
| L1 | 2.74 BSC | | 0.108 REF. | | |
| L2 | 0.51 BSC | | 0.020 BSC | | |
| L3 | 0.89 | 1.27 | 0.035 | 0.050 | 3 |
| L4 | - | 1.02 | - | 0.040 | |
| L5 | 1.14 | 1.52 | 0.045 | 0.060 | 2 |
| Ø | 0° | 10° | 0° | 10° | |
| Ø1 | 0° | 15° | 0° | 15° | |
| Ø2 | 25° | 35° | 25° | 35° | |

Notes

- Dimensioning and tolerancing as per ASME Y14.5M-1994
- Lead dimension uncontrolled in L5
- Dimension D1, E1, L3 and b3 establish a minimum mounting surface for thermal pad
- Section C - C dimension apply to the flat section of the lead between 0.13 and 0.25 mm (0.005 and 0.10") from the lead tip
- Dimension D, and E do not include mold flash. Mold flash shall not exceed 0.127 mm (0.005") per side. These dimensions are measured at the outermost extremes of the plastic body
- Dimension b1 and c1 applied to base metal only
- Datum A and B to be determined at datum plane H
- Outline conforms to JEDEC outline TO-252AA



Disclaimer

ALL PRODUCT, PRODUCT SPECIFICATIONS AND DATA ARE SUBJECT TO CHANGE WITHOUT NOTICE TO IMPROVE RELIABILITY, FUNCTION OR DESIGN OR OTHERWISE.

Vishay Intertechnology, Inc., its affiliates, agents, and employees, and all persons acting on its or their behalf (collectively, "Vishay"), disclaim any and all liability for any errors, inaccuracies or incompleteness contained in any datasheet or in any other disclosure relating to any product.

Vishay makes no warranty, representation or guarantee regarding the suitability of the products for any particular purpose or the continuing production of any product. To the maximum extent permitted by applicable law, Vishay disclaims (i) any and all liability arising out of the application or use of any product, (ii) any and all liability, including without limitation special, consequential or incidental damages, and (iii) any and all implied warranties, including warranties of fitness for particular purpose, non-infringement and merchantability.

Statements regarding the suitability of products for certain types of applications are based on Vishay's knowledge of typical requirements that are often placed on Vishay products in generic applications. Such statements are not binding statements about the suitability of products for a particular application. It is the customer's responsibility to validate that a particular product with the properties described in the product specification is suitable for use in a particular application. Parameters provided in datasheets and/or specifications may vary in different applications and performance may vary over time. All operating parameters, including typical parameters, must be validated for each customer application by the customer's technical experts. Product specifications do not expand or otherwise modify Vishay's terms and conditions of purchase, including but not limited to the warranty expressed therein.

Except as expressly indicated in writing, Vishay products are not designed for use in medical, life-saving, or life-sustaining applications or for any other application in which the failure of the Vishay product could result in personal injury or death. Customers using or selling Vishay products not expressly indicated for use in such applications do so at their own risk and agree to fully indemnify and hold Vishay and its distributors harmless from and against any and all claims, liabilities, expenses and damages arising or resulting in connection with such use or sale, including attorneys fees, even if such claim alleges that Vishay or its distributor was negligent regarding the design or manufacture of the part. Please contact authorized Vishay personnel to obtain written terms and conditions regarding products designed for such applications.

No license, express or implied, by estoppel or otherwise, to any intellectual property rights is granted by this document or by any conduct of Vishay. Product names and markings noted herein may be trademarks of their respective owners.