



2SC4793

NPN SILICON TRANSISTOR

NPN SILICON TRANSISTOR

FEATURES

- *High transition frequency
- *Power amplifier applications
- *Driver stage amplifier applications

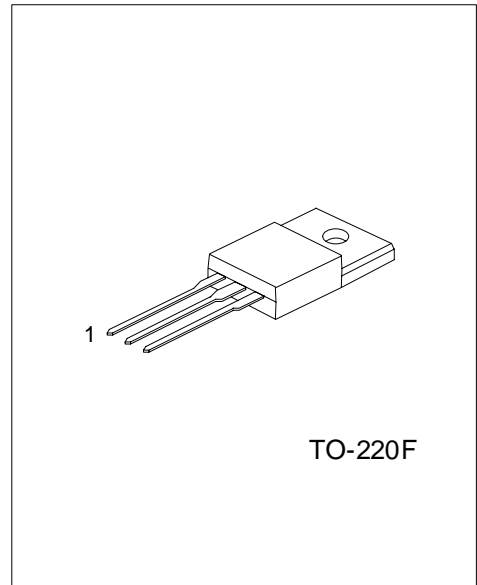

*Pb-free plating product number:2SC4793L

ORDERING INFORMATION

Order Number		Package	Pin Assignment			Packing
Normal	Lead Free Plating		1	2	3	
2SC4793-x-TF3-T	2SC4793L-x-TF3-T	TO-220F	B	C	E	Tube

<p>2C4793L-x-TF3-T</p>	<p>(1) Packing Type</p> <p>(2) Package Type</p> <p>(3) Rank</p> <p>(4) Lead Plating</p>	<p>(1) T: Tube</p> <p>(2) TF3: TO-220F</p> <p>(3) refer to Classification of h_{FE}</p> <p>(4) L: Lead Free Plating, Blank: Pb/Sn</p>
------------------------	-----------------------------------------------------------------------------------------	----------------------------------------------------------------------------------------------------------------------------------------------------

■ ABSOLUTE MAXIMUM RATINGS (Ta=25°C)

PARAMETER	SYMBOL	RATINGS	UNIT	
Collector-Base Voltage	V_{CBO}	230	V	
Collector-Emitter Voltage	V_{CEO}	230	V	
Emitter-Base Voltage	V_{EBO}	5	V	
Collector Current	I_C	1	A	
Base Current	I_B	0.1	A	
Collector Power Dissipation	P_C	Ta=25	2.0	W
		Tc=25	20	W
Junction Temperature	T_J	+150		
Storage Temperature Range	T_{STG}	-55 ~ +150		

Note: Absolute maximum ratings are those values beyond which the device could be permanently damaged.
Absolute maximum ratings are stress ratings only and functional device operation is not implied.

■ ELECTRICAL CHARACTERISTICS (Ta=25°C, unless others specified)

PARAMETER	SYMBOL	TEST CONDITIONS	MIN	TYP	MAX	UNIT
Collector-Emitter Breakdown Voltage	BV_{CEO}	$I_C=10mA, I_B=0$	230			V
Base -Emitter Voltage	V_{BE}	$V_{CE}=5V, I_C=500mA$			1.0	V
Collector-Emitter Saturation Voltage	$V_{CE(SAT)}$	$I_C=500mA, I_B=50mA$			1.5	V
Collector Cut-off Current	I_{CBO}	$V_{CB}=230V, I_E=0$			1.0	μA
Emitter Cut-off Current	I_{EBO}	$V_{EB}=5V, I_C=0$			1.0	μA
DC Current Gain	h_{FE}	$V_{CE}=5V, I_C=100mA$	100		320	
Transition Frequency	f_T	$V_{CE}=10V, I_C=100mA$		100		MHz
Collector Output Capacitance	C_{ob}	$V_{CB}=10V, I_E=0, f=1MHz$		20		pF

■ CLASSIFICATION OF h_{FE}

RANK	A	B
RANGE	100-200	180-320

TYPICAL CHARACTERISTICS

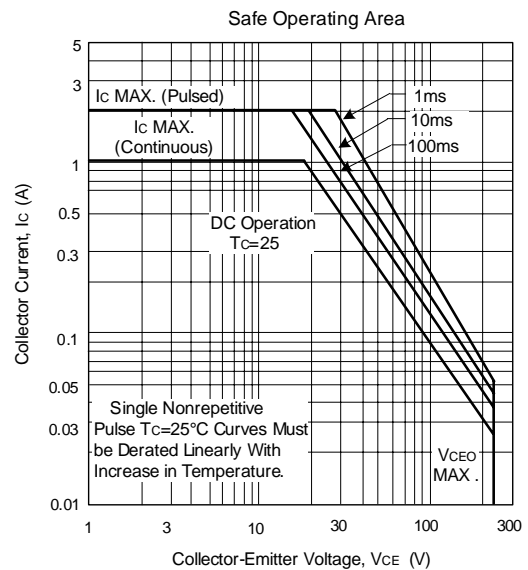
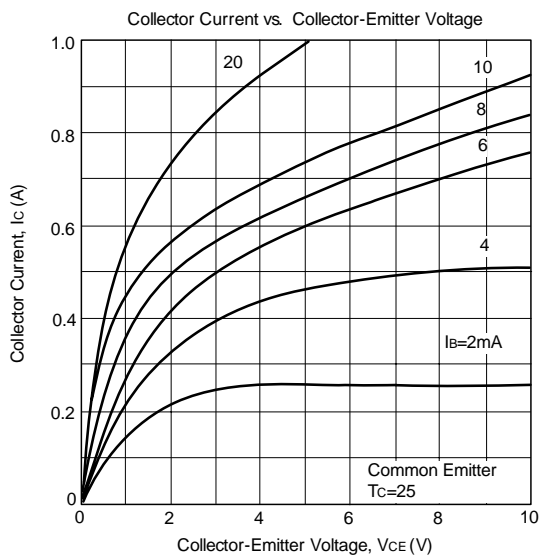
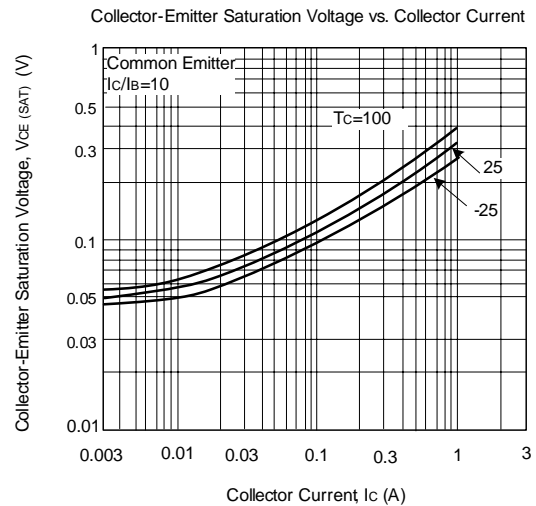
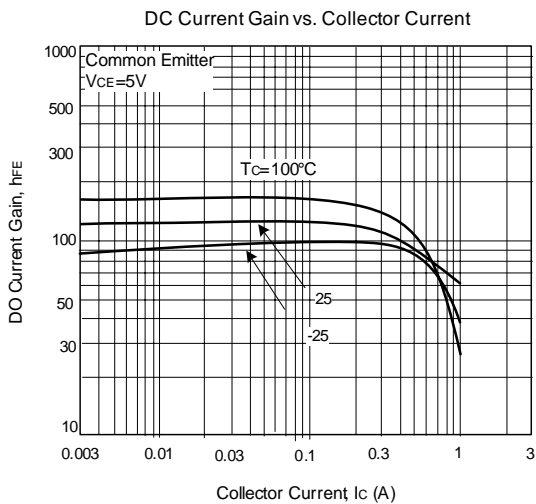
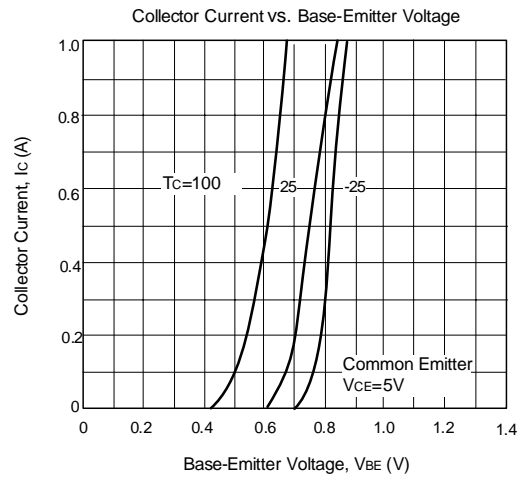
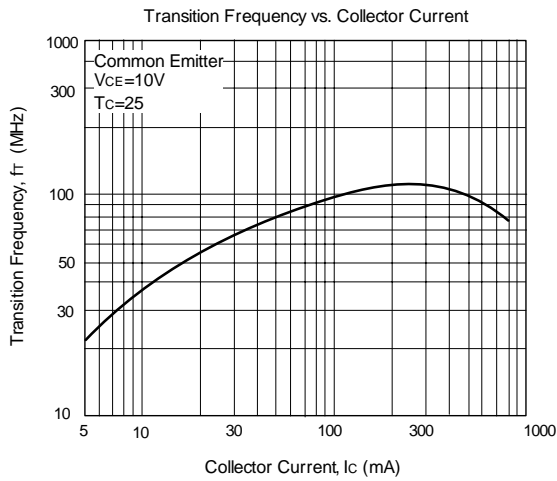

UTC assumes no responsibility for equipment failures that result from using products at values that exceed, even momentarily, rated values (such as maximum ratings, operating condition ranges, or other parameters) listed in products specifications of any and all UTC products described or contained herein. UTC products are not designed for use in life support appliances, devices or systems where malfunction of these products can be reasonably expected to result in personal injury. Reproduction in whole or in part is prohibited without the prior written consent of the copyright owner. The information presented in this document does not form part of any quotation or contract, is believed to be accurate and reliable and may be changed without notice.