

# IRF7311

HEXFET® Power MOSFET

- Generation V Technology
- Ultra Low On-Resistance
- Dual N-Channel MOSFET
- Surface Mount
- Fully Avalanche Rated

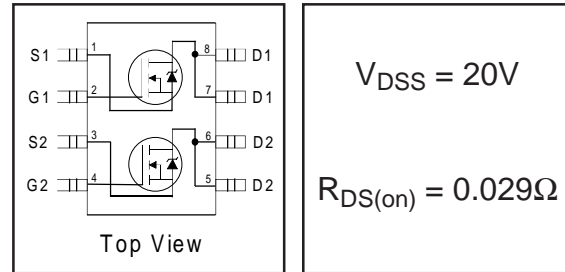

## Description

Fifth Generation HEXFETs from International Rectifier utilize advanced processing techniques to achieve extremely low on-resistance per silicon area. This benefit, combined with the fast switching speed and ruggedized device design that HEXFET Power MOSFETs are well known for, provides the designer with an extremely efficient and reliable device for use in a wide variety of applications.

The SO-8 has been modified through a customized leadframe for enhanced thermal characteristics and multiple-die capability making it ideal in a variety of power applications. With these improvements, multiple devices can be used in an application with dramatically reduced board space. The package is designed for vapor phase, infra red, or wave soldering techniques.

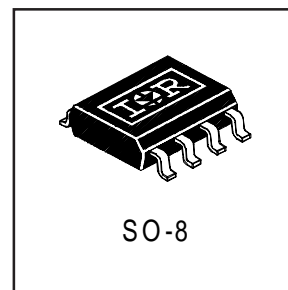

## Absolute Maximum Ratings ( $T_A = 25^\circ C$ Unless Otherwise Noted)

		Symbol	Maximum	Units
Drain-Source Voltage		$V_{DS}$	20	V
Gate-Source Voltage		$V_{GS}$	$\pm 12$	
Continuous Drain Current <sup>⑤</sup>	$T_A = 25^\circ C$	$I_D$	6.6	A
	$T_A = 70^\circ C$		5.3	
Pulsed Drain Current		$I_{DM}$	26	
Continuous Source Current (Diode Conduction)		$I_S$	2.5	
Maximum Power Dissipation <sup>⑤</sup>	$T_A = 25^\circ C$	$P_D$	2.0	W
	$T_A = 70^\circ C$		1.3	
Single Pulse Avalanche Energy <sup>②</sup>		$E_{AS}$	100	mJ
Avalanche Current		$I_{AR}$	4.1	A
Repetitive Avalanche Energy		$E_{AR}$	0.20	mJ
Peak Diode Recovery $dv/dt$ <sup>③</sup>		$dv/dt$	5.0	V/ ns
Junction and Storage Temperature Range		$T_J, T_{STG}$	-55 to + 150	$^\circ C$

## Thermal Resistance Ratings

Parameter	Symbol	Limit	Units
Maximum Junction-to-Ambient <sup>⑤</sup>	$R_{\theta JA}$	62.5	$^\circ C/W$

# IRF7311

International  
 Rectifier

## Electrical Characteristics @ $T_J = 25^\circ\text{C}$ (unless otherwise specified)

	Parameter	Min.	Typ.	Max.	Units	Conditions
$V_{(BR)DSS}$	Drain-to-Source Breakdown Voltage	20	—	—	V	$V_{GS} = 0V, I_D = 250\mu A$
$\Delta V_{(BR)DSS}/\Delta T_J$	Breakdown Voltage Temp. Coefficient	—	0.027	—	V/ $^\circ\text{C}$	Reference to $25^\circ\text{C}, I_D = 1\text{mA}$
$R_{DS(on)}$	Static Drain-to-Source On-Resistance	—	0.023	0.029	$\Omega$	$V_{GS} = 4.5V, I_D = 6.0A$ ④
		—	0.030	0.046		$V_{GS} = 2.7V, I_D = 5.2A$ ④
$V_{GS(th)}$	Gate Threshold Voltage	0.7	—	—	V	$V_{DS} = V_{GS}, I_D = 250\mu A$
$g_{fs}$	Forward Transconductance	—	20	—	S	$V_{DS} = 10V, I_D = 6.0A$
$I_{DSS}$	Drain-to-Source Leakage Current	—	—	1.0	$\mu A$	$V_{DS} = 16V, V_{GS} = 0V$
		—	—	5.0		$V_{DS} = 16V, V_{GS} = 0V, T_J = 55^\circ\text{C}$
$I_{GSS}$	Gate-to-Source Forward Leakage	—	—	100	nA	$V_{GS} = 12V$
	Gate-to-Source Reverse Leakage	—	—	-100		$V_{GS} = -12V$
$Q_g$	Total Gate Charge	—	18	27	nC	$I_D = 6.0A$
$Q_{gs}$	Gate-to-Source Charge	—	2.2	3.3		$V_{DS} = 10V$
$Q_{gd}$	Gate-to-Drain ("Miller") Charge	—	6.2	9.3		$V_{GS} = 4.5V$ , See Fig. 10 ④
$t_{d(on)}$	Turn-On Delay Time	—	8.1	12	ns	$V_{DD} = 10V$
$t_r$	Rise Time	—	17	25		$I_D = 1.0A$
$t_{d(off)}$	Turn-Off Delay Time	—	38	57		$R_G = 6.0\Omega$
$t_f$	Fall Time	—	31	47		$R_D = 10\Omega$ ④
$C_{iss}$	Input Capacitance	—	900	—	pF	$V_{GS} = 0V$
$C_{oss}$	Output Capacitance	—	430	—		$V_{DS} = 15V$
$C_{riss}$	Reverse Transfer Capacitance	—	200	—		$f = 1.0\text{MHz}$ , See Fig. 9

## Source-Drain Ratings and Characteristics

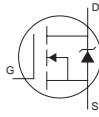
	Parameter	Min.	Typ.	Max.	Units	Conditions
$I_S$	Continuous Source Current (Body Diode)	—	—	2.5	A	MOSFET symbol showing the integral reverse p-n junction diode. 
$I_{SM}$	Pulsed Source Current (Body Diode) ①	—	—	26		
$V_{SD}$	Diode Forward Voltage	—	0.72	1.0	V	$T_J = 25^\circ\text{C}, I_S = 1.7A, V_{GS} = 0V$ ③
$t_{rr}$	Reverse Recovery Time	—	52	77	ns	$T_J = 25^\circ\text{C}, I_F = 1.7A$
$Q_{rr}$	Reverse Recovery Charge	—	58	86	nC	$di/dt = 100A/\mu s$ ③

### Notes:

- ① Repetitive rating; pulse width limited by max. junction temperature. ( See fig. 11 )
- ② Starting  $T_J = 25^\circ\text{C}$ ,  $L = 12\text{mH}$   
 $R_G = 25\Omega, I_{AS} = 4.1A$ .
- ③  $I_{SD} \leq 4.1A, di/dt \leq 92A/\mu s, V_{DD} \leq V_{(BR)DSS}, T_J \leq 150^\circ\text{C}$
- ④ Pulse width  $\leq 300\mu s$ ; duty cycle  $\leq 2\%$ .
- ⑤ Surface mounted on 1 in square Cu board

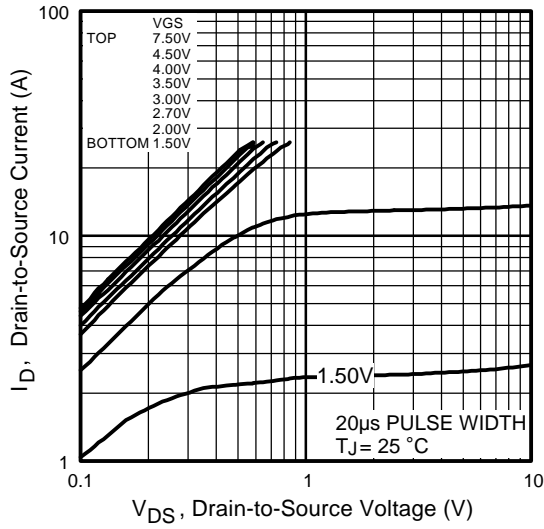

**Fig 1.** Typical Output Characteristics

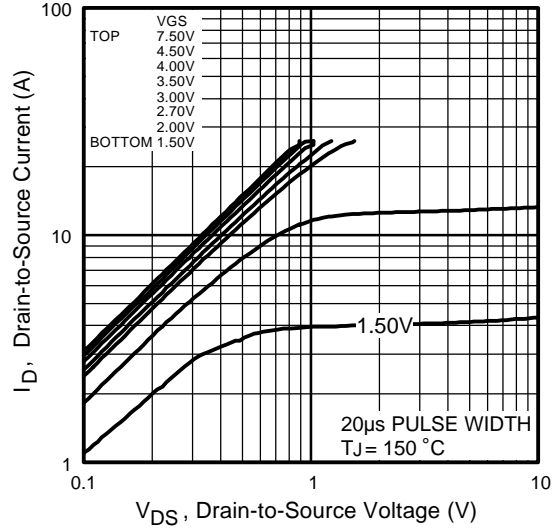

**Fig 2.** Typical Output Characteristics

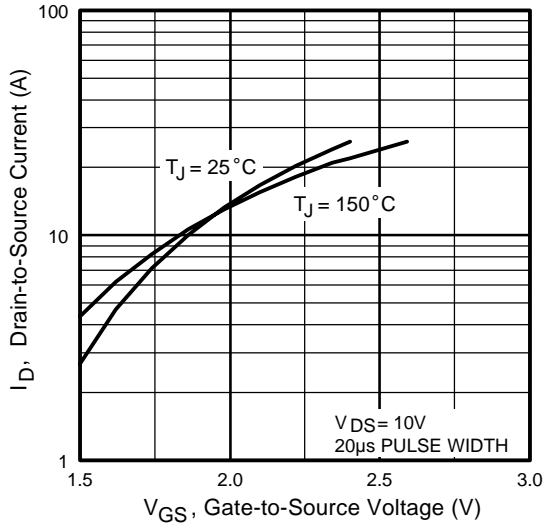

**Fig 3.** Typical Transfer Characteristics

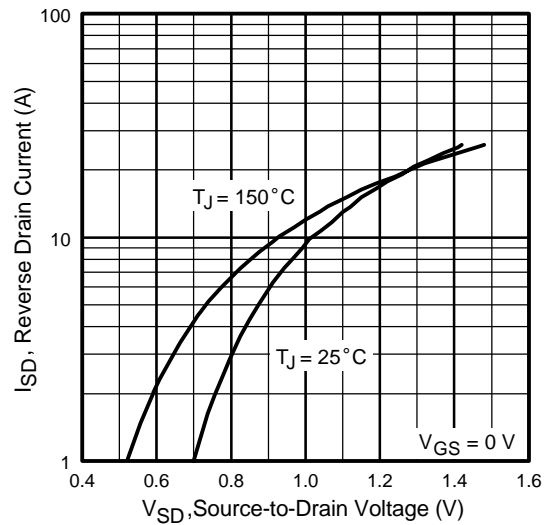

**Fig 4.** Typical Source-Drain Diode Forward Voltage

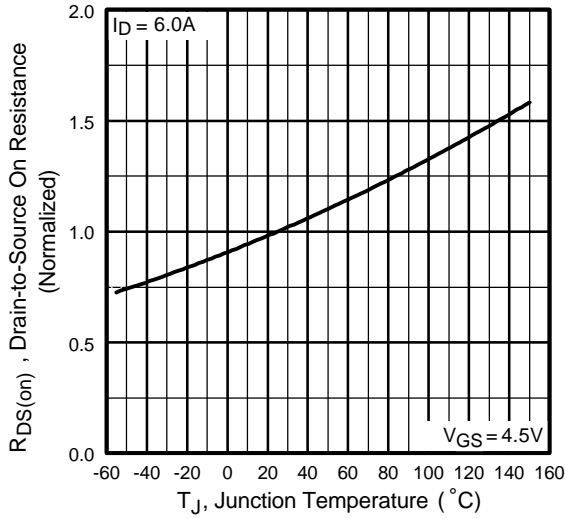

**Fig 5.** Normalized On-Resistance Vs. Temperature

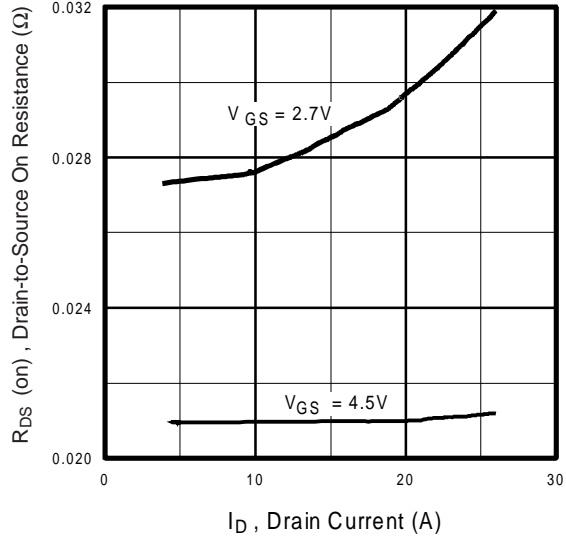

**Fig 6.** Typical On-Resistance Vs. Drain Current

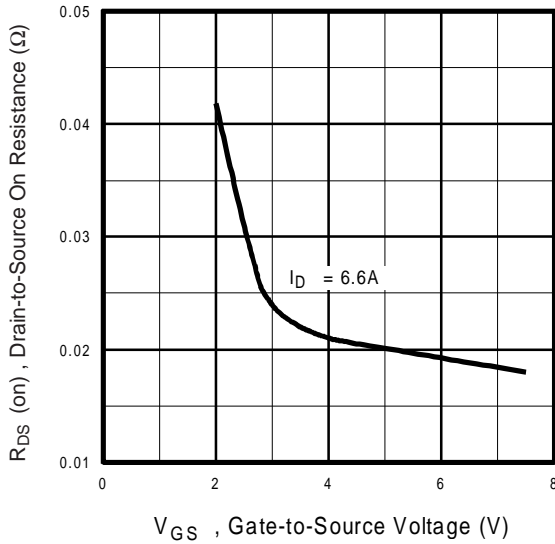

**Fig 7.** Typical On-Resistance Vs. Gate Voltage

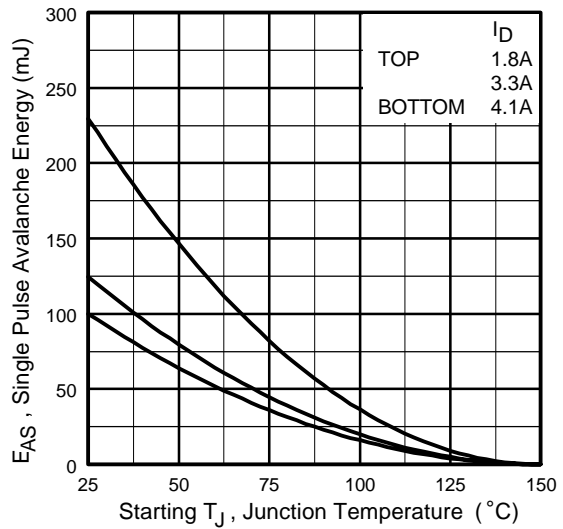

**Fig 8.** Maximum Avalanche Energy Vs. Drain Current

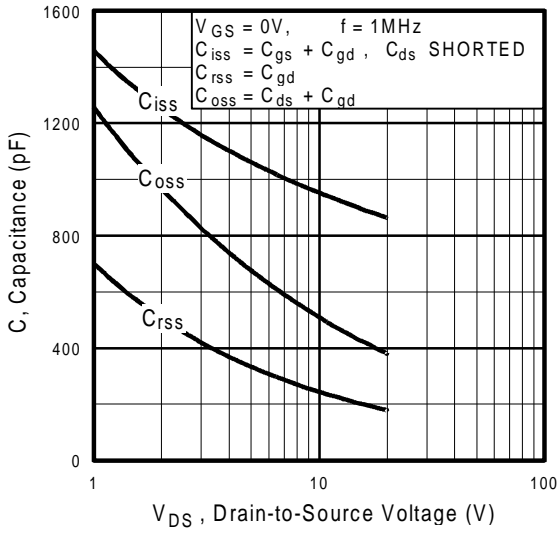

**Fig 9.** Typical Capacitance Vs. Drain-to-Source Voltage

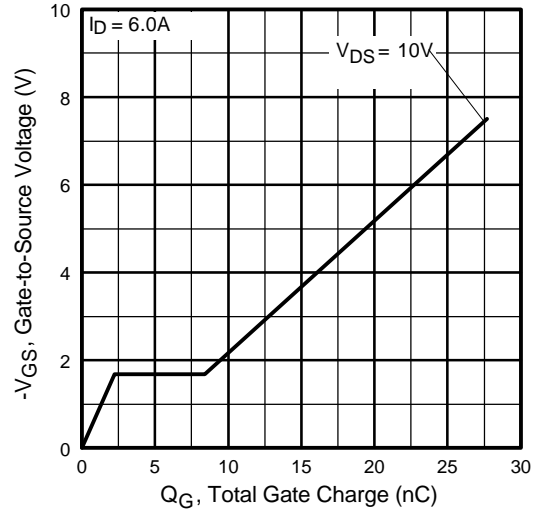

**Fig 10.** Typical Gate Charge Vs. Gate-to-Source Voltage

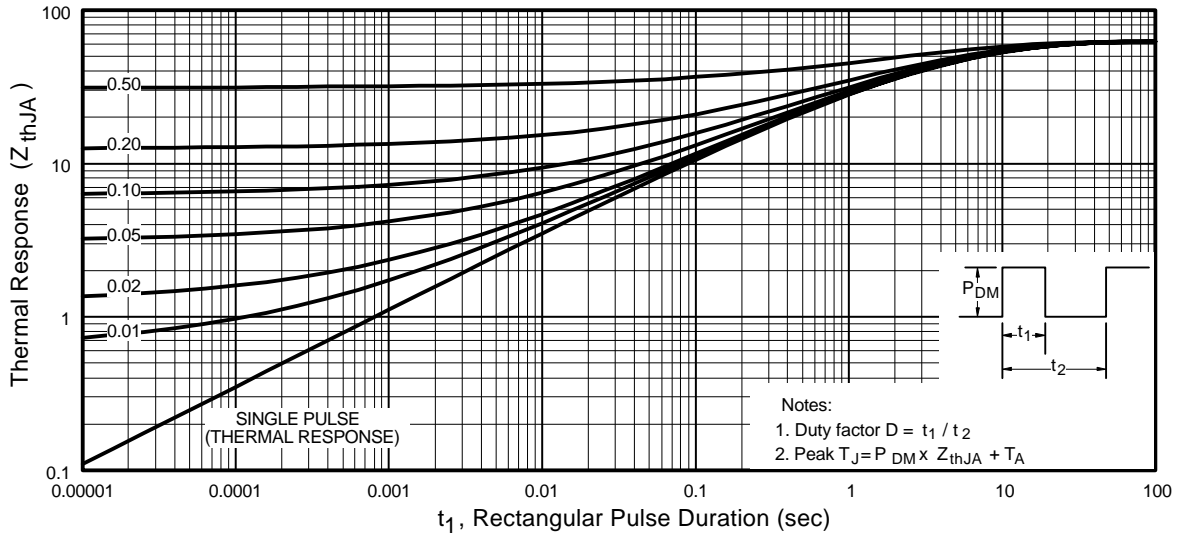
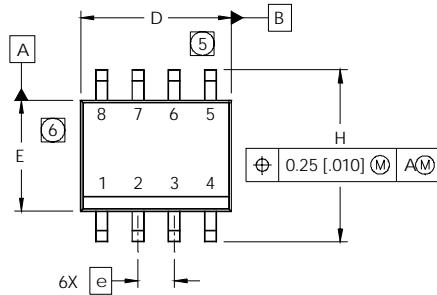

**Fig 11.** Maximum Effective Transient Thermal Impedance, Junction-to-Ambient

# IRF7311

International  
**IR** Rectifier

## SO-8 Package Details



DIM	INCHES		MILLIMETERS	
	MIN	MAX	MIN	MAX
A	.0532	.0688	1.35	1.75
A1	.0040	.0098	0.10	0.25
b	.013	.020	0.33	0.51
c	.0075	.0098	0.19	0.25
D	.189	.1968	4.80	5.00
E	.1497	.1574	3.80	4.00
e	.050 BASIC		1.27 BASIC	
e1	.025 BASIC		0.635 BASIC	
H	.2284	.2440	5.80	6.20
K	.0099	.0196	0.25	0.50
L	.016	.050	0.40	1.27
y	0°	8°	0°	8°

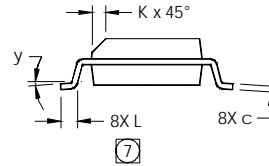
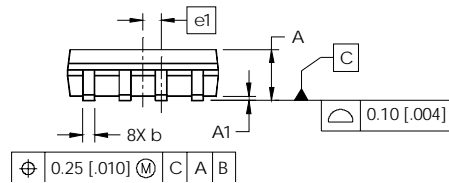

### NOTES:

1. DIMENSIONING & TOLERANCING PER ASME Y14.5M-1994.
2. CONTROLLING DIMENSION: MILLIMETER
3. DIMENSIONS ARE SHOWN IN MILLIMETERS [INCHES].
4. OUTLINE CONFORMS TO JEDEC OUTLINE MS-012AA.
5. DIMENSION DOES NOT INCLUDE MOLD PROTRUSIONS. MOLD PROTRUSIONS NOT TO EXCEED 0.15 [0.006].
6. DIMENSION DOES NOT INCLUDE MOLD PROTRUSIONS. MOLD PROTRUSIONS NOT TO EXCEED 0.25 [0.010].
7. DIMENSION IS THE LENGTH OF LEAD FOR SOLDERING TO A SUBSTRATE.

### FOOTPRINT

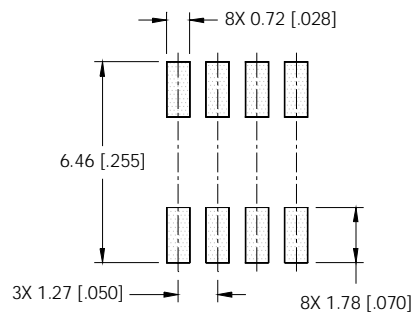

## SO-8 Part Marking

EXAMPLE: THIS IS AN IRF7101 (MOSFET)

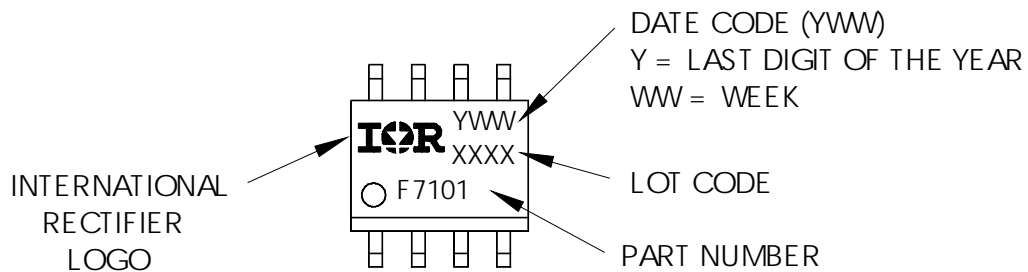

## SO-8 Tape and Reel

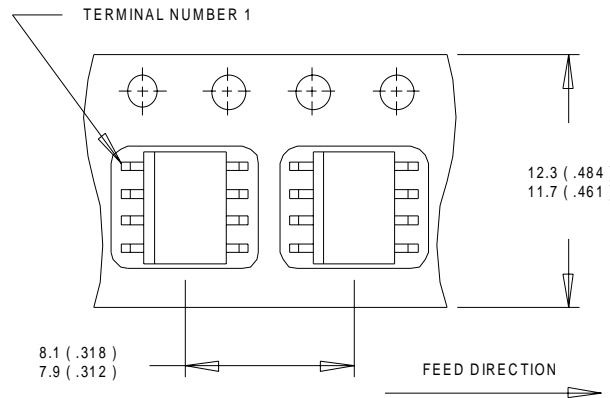

- NOTES:
1. CONTROLLING DIMENSION : MILLIMETER.
  2. ALL DIMENSIONS ARE SHOWN IN MILLIMETERS(INCHES).
  3. OUTLINE CONFORMS TO EIA-481 & EIA-541.

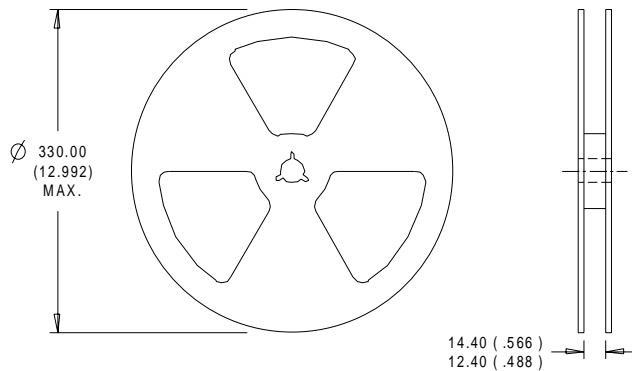

- NOTES :
1. CONTROLLING DIMENSION : MILLIMETER.
  2. OUTLINE CONFORMS TO EIA-481 & EIA-541.

Data and specifications subject to change without notice.  
 This product has been designed and qualified for the Industrial market.  
 Qualification Standards can be found on IR's Web site.

International  
**IR** Rectifier

IR WORLD HEADQUARTERS: 233 Kansas St., El Segundo, California 90245, USA Tel: (310) 252-7105  
 TAC Fax: (310) 252-7903

Visit us at [www.irf.com](http://www.irf.com) for sales contact information. 5/01