

Standard SCRs, 40A

Main Features

Symbol	Value	Unit
$I_{T(RMS)}$	40	A
V_{DRM}/V_{RRM}	600 to 1600	V
I_{GT}	4 to 35	mA

DESCRIPTION

The 40PT series of silicon controlled rectifiers are high performance glass passivated technology, and are suitable for general purpose applications, where in-rush current conditions are critical such as overvoltage crowbar protection circuits in power supplies, in-rush current limiting circuits, solid state relay in back to back configuration, welding equipment and high power motor control.

Base on a clip assembly technology, they offer a superior performance in surge current capabilities.

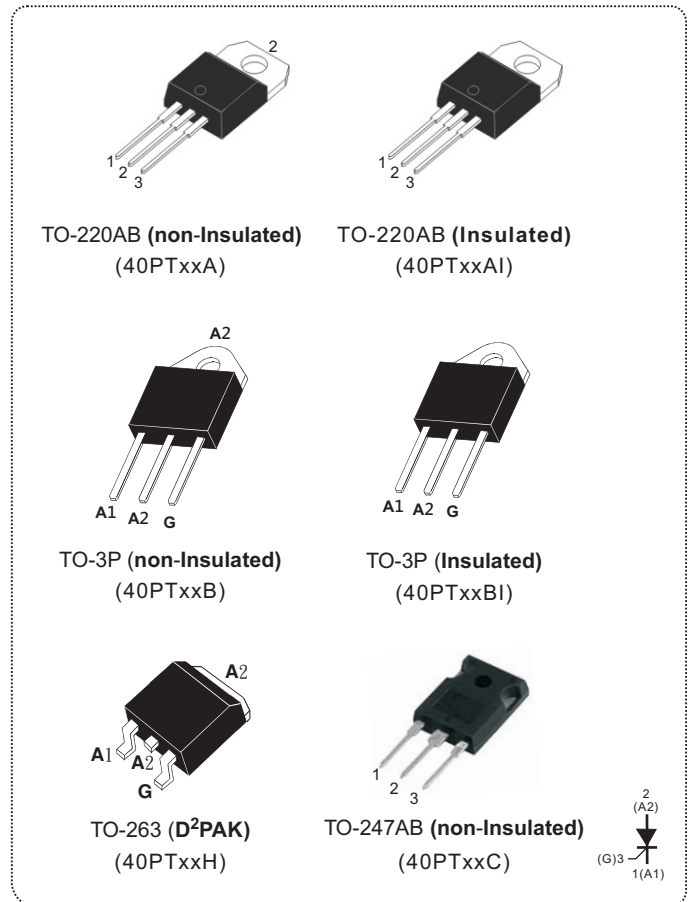

ABSOLUTE MAXIMUM RATINGS					
PARAMETER	SYMBOL	TEST CONDITIONS		VALUE	UNIT
RMS on-state current full sine wave (180° conduction angle)	$I_{T(RMS)}$	TO-3P/TO-247AB	$T_c=95^\circ\text{C}$	40	A
		TO-220AB/TO-263	$T_c=90^\circ\text{C}$		
		TO-220AB insulated/TO-3P insulated	$T_c=80^\circ\text{C}$		
Average on-state current (180° conduction angle)	$I_{T(AV)}$	TO-3P/TO-247AB	$T_c=95^\circ\text{C}$	25	A
		TO-220AB/TO-263	$T_c=90^\circ\text{C}$		
		TO-220AB insulated/TO-3P insulated	$T_c=80^\circ\text{C}$		
Non repetitive surge peak on-state current (full cycle, T_j initial = 25°C)	I_{TSM}	F = 50 Hz	t = 20 ms	460	A
		F = 60 Hz	t = 16.7 ms	480	
I^2t Value for fusing	I^2t	$t_p = 10$ ms		1058	A ² s
Critical rate of rise of on-state current $I_G = 2 \times I_{GT}$, $t_r \leq 100$ ns	di/dt	F = 60 Hz	$T_j = 125^\circ\text{C}$	50	A/ μ s
Peak gate current	I_{GM}	$T_p = 20$ μ s	$T_j = 125^\circ\text{C}$	4	A
Maximum gate power	P_{GM}	$T_p = 20$ μ s	$T_j = 125^\circ\text{C}$	10	W
Average gate power dissipation	$P_{G(AV)}$	$T_j = 125^\circ\text{C}$		1	W
Repetitive peak off-state voltage	V_{DRM}	$T_j = 125^\circ\text{C}$		600 to 1600	V
Repetitive peak reverse voltage	V_{RRM}				
Storage temperature range	T_{stg}			- 40 to + 150	°C
Operating junction temperature range	T_j			- 40 to + 125	
Maximum peak reverse gate voltage	V_{RGM}			5	V

ELECTRICAL SPECIFICATIONS (T _j = 25 °C unless otherwise specified)						
SYMBOL	TEST CONDITIONS			40PTxxxx	Unit	
I _{GT}	V _D = 12V, R _L = 33Ω			Min.	4	mA
V _{GT}				Max.	35	
V _{GD}	V _D = V _{DRM} , R _L = 3.3KΩ, R _{GK} = 220Ω	T _j = 125°C	Min.	0.2	V	
I _H	I _T = 500mA, Gate open			Max.	75	mA
I _L	I _G = 1.2×I _{GT}			Max.	150	mA
dV/dt	V _D = 67% V _{DRM} , Gate open	T _j = 125°C	Min.	1000	V/μs	
V _{TM}	I _T = 80A, t _p = 380μs			Max.	1.6	V
I _{DRM} I _{RRM}	V _D = V _{DRM} , V _R = V _{RRM} R _{GK} = 220Ω		T _j = 25°C	Max.	10	μA
			T _j = 125°C	Max.	4	mA
V _{to}	Threshold Voltage			Max.	0.85	V
R _d	Dynamic Resistance			Max.	10	mΩ

THERMAL RESISTANCE						
SYMBOL	Parameter			VALUE	UNIT	
R _{th(j-c)}	Junction to case (DC)			D ² PAK/TO-220AB/TO-3P/TO-247AB	0.8	°C/W
				TO-220AB insulated/TO-3P insulated	0.9	
R _{th(j-a)}	S = 1 cm ²			TO-263(D ² PAK)	45	°C/W
				TO-220AB/TO-220AB insulated	60	
				TO-3P/TO-247AB/TO-3P insulated	50	

S=Copper surface under tab

PRODUCT SELECTOR							
PART NUMBER	VOLTAGE (xx)					SENSITIVITY	PACKAGE
	600 V	800 V	1000 V	1200 V	1600 V		
40PTxxA/40PTxxAI	V	V	V	V	V	35 mA	TO-220AB
40PTxxH	V	V	V	V	V	35 mA	D ² PAK
40PTxxB/40PTxxBI	V	V	V	V	V	35 mA	TO-3P
40PTxxC	V	V	V	V	V	35 mA	TO-247AB

ORDERING INFORMATION					
ORDERING TYPE	MARKING	PACKAGE	WEIGHT	BASE Q'TY	DELIVERY MODE
40PTxxA	40PTxxA	TO-220AB	2.0g	50	Tube
40PTxxAI	40PTxxAI	TO-220AB (insulated)	2.3g	50	Tube
40PTxxH	40PTxxH	TO-263(D ² PAK)	2.0g	50	Tube
40PTxxB	40PTxxB	TO-3P	4.3g	30	Tube
40PTxxBI	40PTxxBI	TO-3P insulated	4.8g	30	Tube
40PTxxC	40PTxxC	TO-247AB	5g	30	Tube

Note: xx = voltage

ORDERING INFORMATION SCHEME

40 PT 06 AI

Current

40 = 40A, $I_{T(RMS)}$

SCR series

Voltage Code

06 = 600V
 08 = 800V
 10 = 1000V
 12 = 1200V
 16 = 1600V

Package type

A = TO-220AB (non-insulated)
 AI = TO-220AB (insulated)
 B = TO-3P (non-insulated)
 BI = TO-3P (insulated)
 C = TO-247AB
 H = TO-263 (D²PAK)

Fig.1 Maximum average power dissipation versus average on-state current.

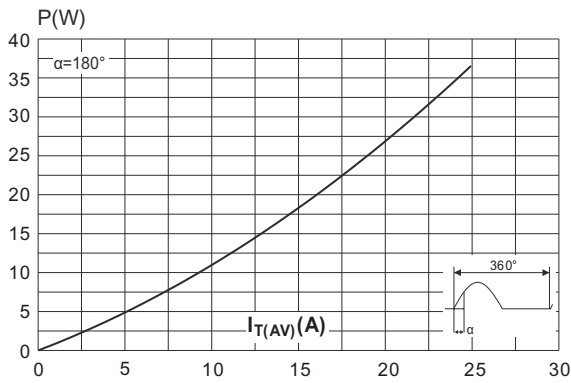

Fig.2 RMS on-state current versus case temperature.

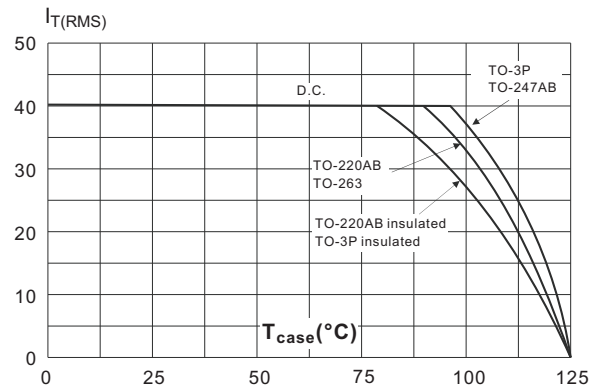

Fig.3 Relative variation of thermal impedance versus pulse duration.

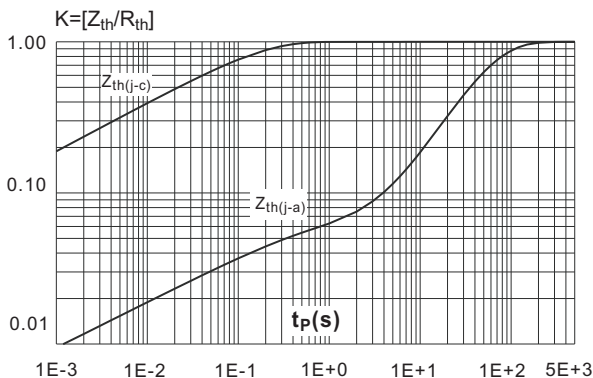

Fig.4 Relative variation of gate trigger current, holding current and latching current versus junction temperature.

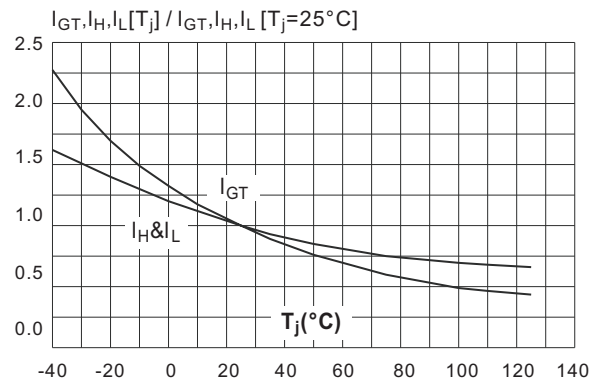

Fig.5 Surge peak on-state current versus number of cycles.

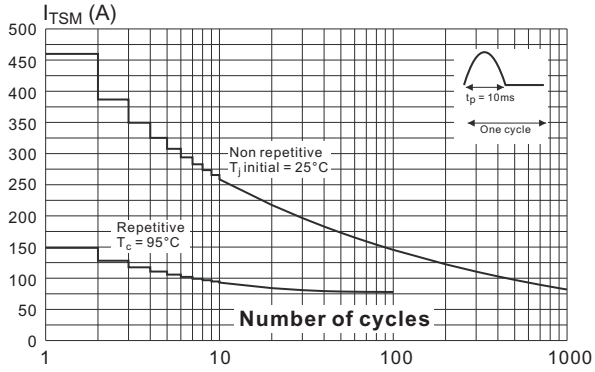

Fig.6 Non-repetitive surge peak on-state current for a sinusoidal pulse with width $t_p < 10$ ms, and corresponding values of I^2t .

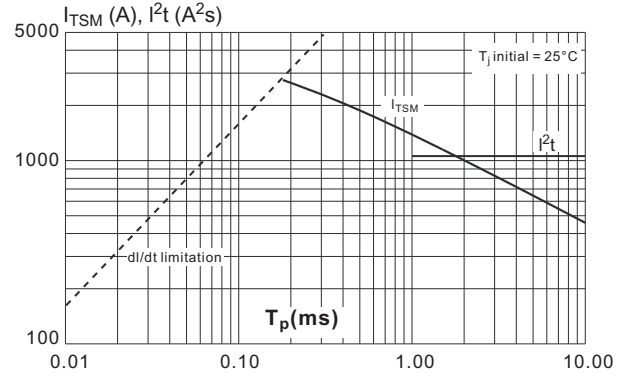
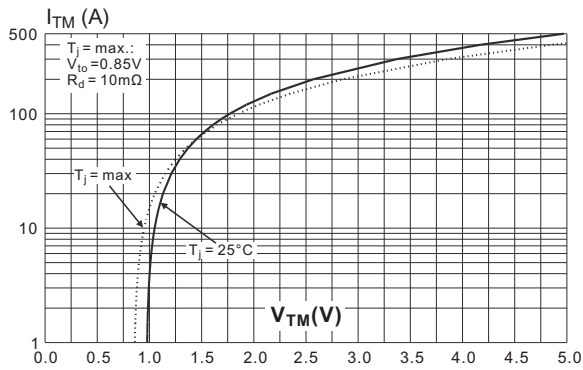
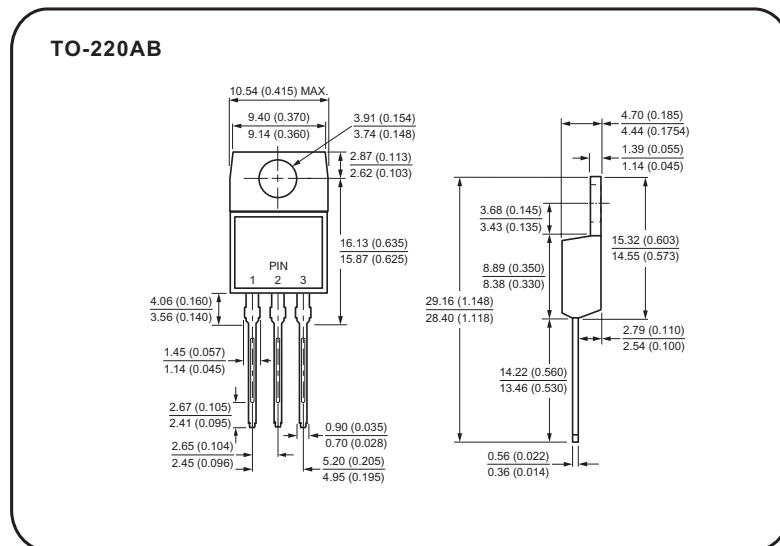

Fig.7 On-state characteristics (maximum values)



Case Style



All dimensions in millimeters(inches)

Case Style

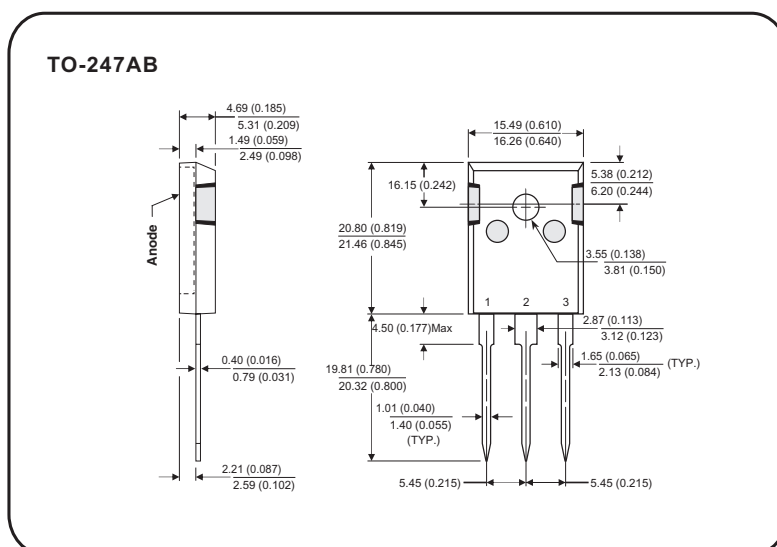
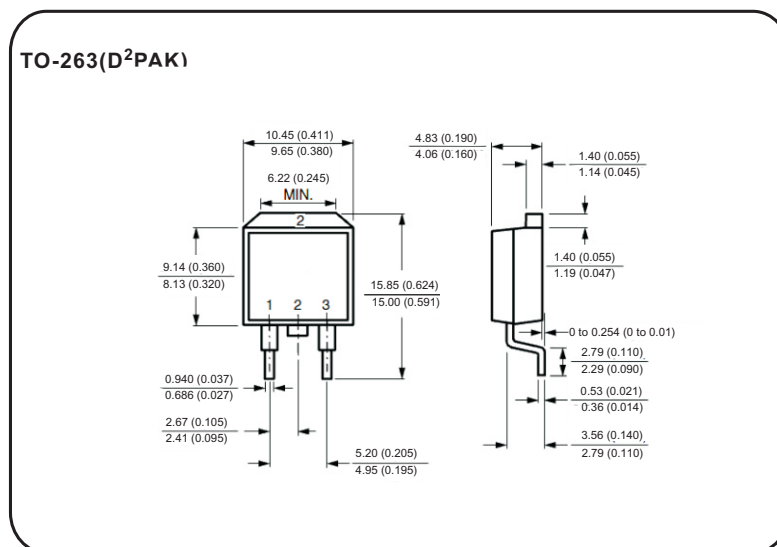
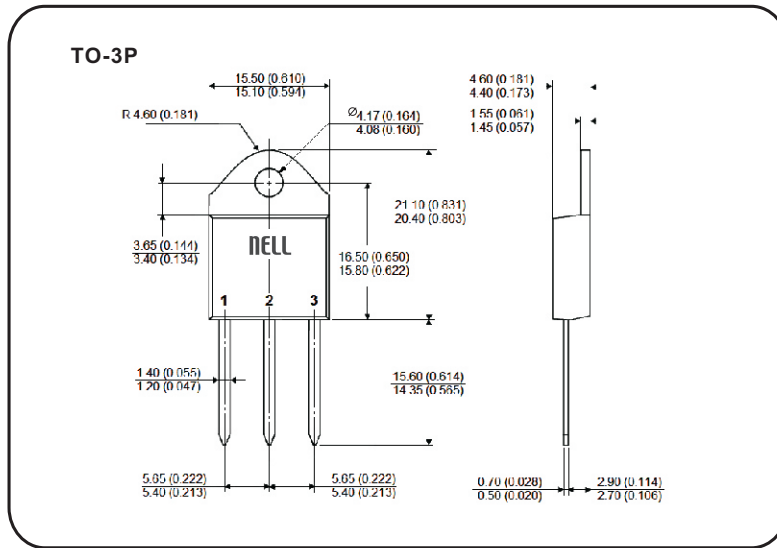

All dimensions in millimeters(inches)

