

Selection Guide

Part No.	Dice	Lens Type	Iv (ucd) [1] @ 10mA		Description
			Min.	Typ.	
CA25-12YWA	YELLOW (GaAsP/GaP)	WHITE DIFFUSED	1200	4850	Common Anode

Note:

1. Luminous intensity / luminous flux: +/-15%.

Electrical / Optical Characteristics at TA=25°C

Symbol	Parameter		Device	Typ.	Max.	Units	Test Conditions
λ_{peak}	Peak Wavelength		Yellow	590		nm	IF=20mA
λ_D [1]	Dominant Wavelength		Yellow	588		nm	IF=20mA
$\Delta\lambda_{1/2}$	Spectral Line Half-width		Yellow	35		nm	IF=20mA
C	Capacitance		Yellow	20		pF	VF=0V;f=1MHz
VF [2]	Forward Voltage	Dig1'8,'Dig2'8',Dig3'8',Dig4'8' D1,D2,D3D4,D5,D6,D8	Yellow	2.1	2.5	V	IF=20mA
		D7,L					
IR	Reverse Current	Dig1'8,'Dig2'8',Dig3'8',Dig4'8' D1,D2,D3D4,D5,D6,D8	Yellow		10	uA	VR = 5V
		D7,L			20		

Notes:

1. Wavelength: +/-1nm.

2. Forward Voltage: +/-0.1V.

Absolute Maximum Ratings at TA=25°C

Parameter		Yellow	Units
Power dissipation	Dig1'8,'Dig2'8',Dig3'8',Dig4'8' D1,D2,D3D4,D5,D6,D8	75	mW
	D7,L	150	
DC Forward Current	Dig1'8,'Dig2'8',Dig3'8',Dig4'8' D1,D2,D3D4,D5,D6,D8	30	mA
	D7,L	60	
Reverse Voltage	Dig1'8,'Dig2'8',Dig3'8',Dig4'8' D1,D2,D3D4,D5,D6,D8	5	V
	D7,L		
Peak Forward Current [1]	Dig1'8,'Dig2'8',Dig3'8',Dig4'8' D1,D2,D3D4,D5,D6,D8	140	mA
	D7,L	280	
Operating/Storage Temperature		-40°C To +85°C	
Lead Solder Temperature [2]		260°C For 3~5 Seconds	

Notes:

1. 1/10 Duty Cycle, 0.1ms Pulse Width.

2. 2mm below package base.

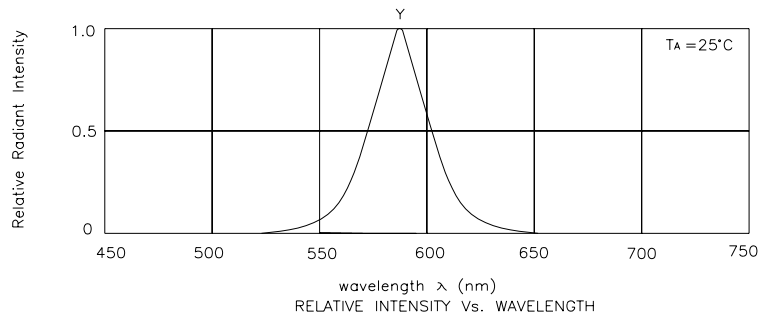

Yellow

CA25-12YWA

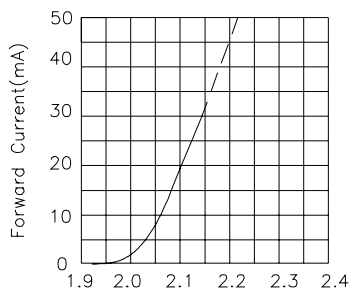

Forward Voltage(V)
FORWARD CURRENT Vs
FORWARD VOLTAGE

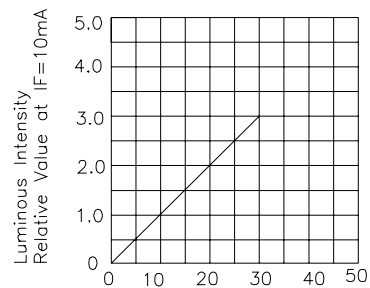

I_F —Forward Current (mA)
LUMINOUS INTENSITY Vs.
FORWARD CURRENT

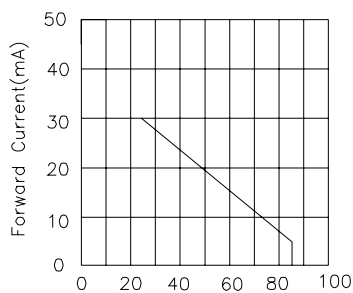

FORWARD CURRENT
DERATING CURVE

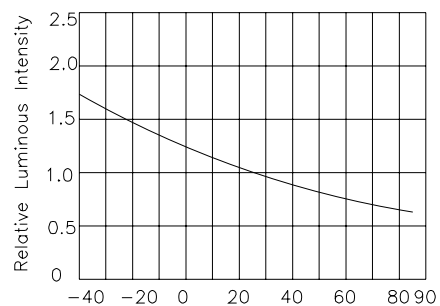

AMBIENT TEMPERATURE T_A ($^\circ\text{C}$)
LUMINOUS INTENSITY Vs.
AMBIENT TEMPERATURE

Yellow

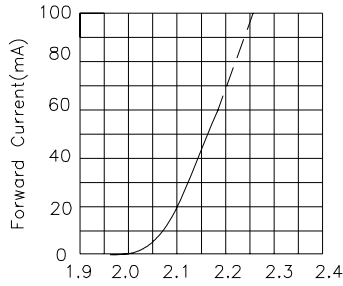

Forward Voltage(V)
FORWARD CURRENT Vs
FORWARD VOLTAGE

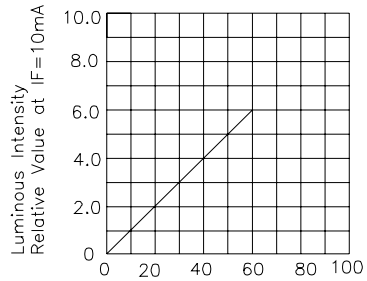

IF-Forward Current (mA)
LUMINOUS INTENSITY Vs.
FORWARD CURRENT

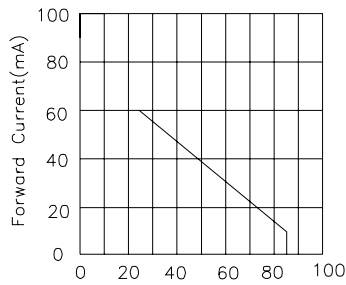

Ambient Temperature TA(°C)
FORWARD CURRENT
DERATING CURVE

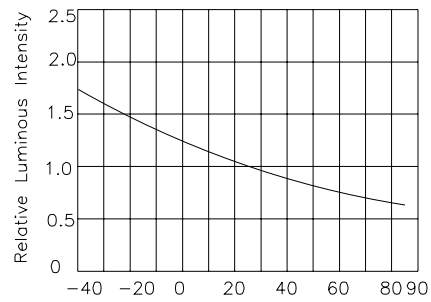

Ambient Temperature TA(°C)
LUMINOUS INTENSITY Vs.
AMBIENT TEMPERATURE

PACKING & LABEL SPECIFICATIONS

CA25-12YWA

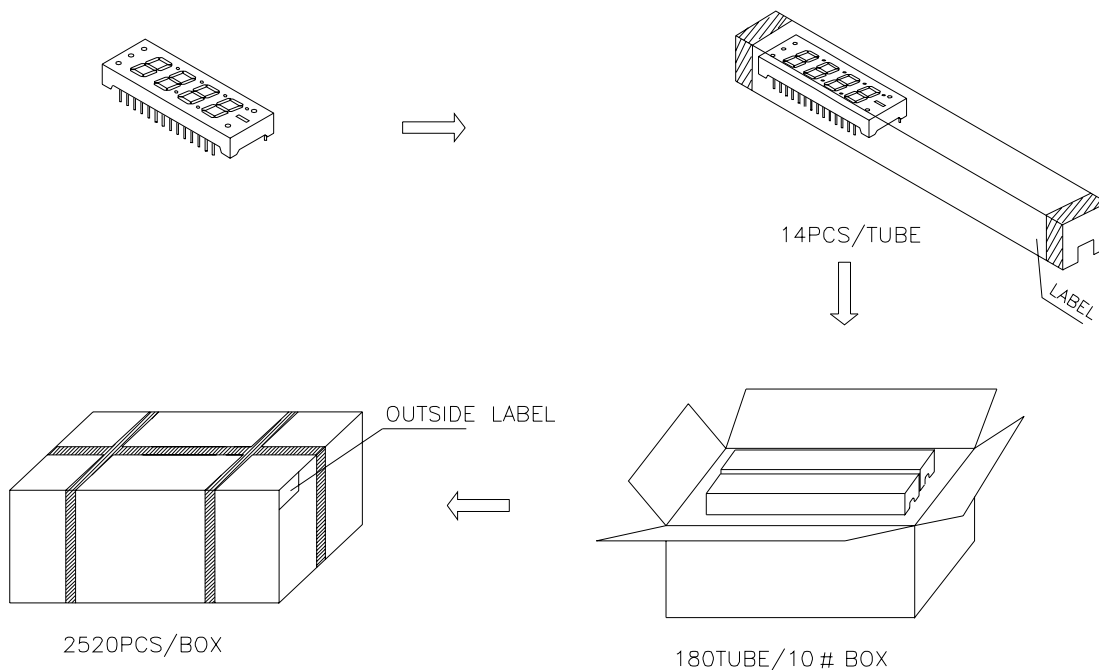

Inside LABEL Paste On The IC-pipe

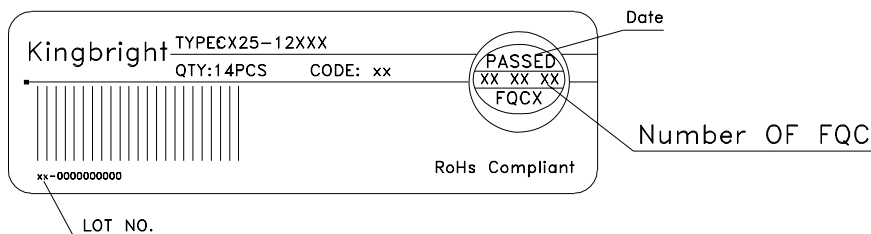

Outside LABEL Paste On The Box

