

## VTM™ Transformer

- Isolated 1-50 Vout
- High density
- Small footprint
- ZVS / ZCS Sine Amplitude Converter™
- 3 MHz effective switching frequency
- Surface-mount package
- Low weight
- -55°C to 125°C operation
- 1 μs transient response
- 4.5 million hours MTBF
- Up to 96.5% efficiency

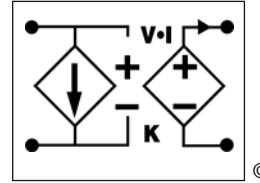

### Product Description

The VTM Transformer is a V·I Chip™ product that provides extremely fast, efficient, and quiet fixed ratio voltage division (or current multiplication). With twelve voltage division ratios from 1:1 to 1:32, the isolated VTM provides the user with the flexibility to supply up to 100 A or 120 W at any output voltage from 1 to 50 Vdc in a surface mount package occupying ~1 square inch.

The Military VTMs are optimized for use with the Military PRM™ Regulator to implement a Factorized Power Architecture™ (FPA™). Together, the PRM + VTM chip set provides the full functionality of a DC-DC converter, but with breakthrough performance and flexibility in a rugged, miniature package. The companion PRM for the MV036 family of VTMs is the 28 Vdc input MP028F036M12AL, which operates from an input range of 16-50 Vdc (the data sheet is available at vicorpower.com). The VTM can also be used as a standalone POL product.

By factorizing the DC-DC power conversion into its essential elements – the VTM’s isolation and transformation on the one hand, and the PRM’s output voltage control and regulation on the other – and arranging those functions in a sequence that maximizes system performance, FPA offers a fundamentally new and significantly improved approach to power conversion.

The VTM’s fast dynamic response and low noise eliminate the need for bulk capacitance at the load, substantially increasing the POL density while improving reliability and decreasing cost. The low profile VTM (0.265 inches, 6,73 mm) is available with J-leads for surface mount or pins for through hole applications.

### Absolute Maximum Ratings

Parameter	Values	Unit	Notes
+In to -In	-1.0 to 60	Vdc	
	100	Vdc	For 100 ms
PC to -In	-0.3 to 7.0	Vdc	
VC to -In	-0.3 to 19.0	Vdc	
+Out to -Out	Model specific	Vdc	Contact factory
Isolation voltage	2,250	Vdc	Input to Output
Output current	Model specific	A	See Table 1
Peak output current	1.5 • Iout	A	For 1 ms
Output power	120	W	
Peak output power	180	W	For 1 ms
Case temperature	225	°C	MSL 5
	245	°C	MSL 6
Operating junction temperature <sup>[a]</sup>	-55 to 125	°C	M - Grade
Storage temperature	-65 to 125	°C	M - Grade

**Note:**

[a] The referenced junction is defined as the semiconductor having the highest temperature. This temperature is monitored by a shutdown comparator.

### Part Numbering Format

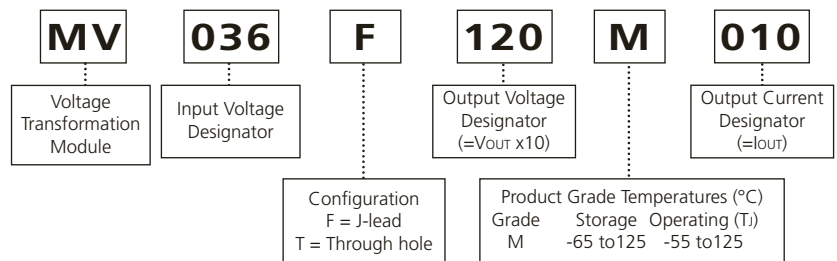

## Electrical Specifications

### Input Specs (Conditions are at 36 V<sub>in</sub>, full load, and 25°C ambient unless otherwise specified)

Parameter	Min	Typ	Max	Unit	Note
Input voltage range	26	36	50	Vdc	Operable down to zero V with VC voltage applied
Input dV/dt			1	V/μs	
Input overvoltage turn-on	50.5	54.4		Vdc	
Input overvoltage turn-off		55.5	57.5	Vdc	
Input current			3.5	Adc	Continuous
No load power dissipation	1.5	3.0	6.0	W	Low line to high line

### Output Specs (Conditions are at 36 V<sub>in</sub>, full load, and 25°C ambient unless otherwise specified)

Parameter	Min	Typ	Max	Unit	Note
Output voltage	See Table 1			Vdc	No load
	$K \cdot V_{IN} - I_o \cdot R_{OUT\ NOM}$			Vdc	Full load
Rated DC current	0		100	Adc	26 - 50 V <sub>IN</sub> See Table 1
Peak repetitive current			150%	I <sub>MAX</sub> (A)	Max pulse width 1ms, max duty cycle 10%, baseline power 50%
DC current limit		160%		I <sub>NOM</sub> (A)	Module will shut down when current limit is reached or exceeded
Current share accuracy		5	10	%	
Efficiency					See Table 2, Page 3
Load capacitance					See Table 2 when used with PRM
Output overvoltage setpoint		110%	115%	V <sub>OUT MAX</sub>	
Output ripple voltage (typ)					
No external bypass	50		250	mV	See Figures 2 and 5
10 μF bypass capacitor	2		20	mV	See Figure 6
Effective switching frequency	2.5	3.0	3.6	MHz	Model dependent
Line regulation	0.99K	K	1.01K		V <sub>OUT</sub> = K • V <sub>IN</sub> at no load, See Table 1
Load regulation	R <sub>OUTMIN</sub>		R <sub>OUTMAX</sub>	mΩ	See Table 1
Transient response					
Response time		200		ns	See Figures 7 and 8
Recovery time		1		μs	See Figures 7 and 8

**Military Cots VTM Family Part Numbers and Ranges**

Part Number	K-Factor	Rated Output Current (A)	No Load Output Voltage (Vdc)		Rout (mΩ)		
			@26 Vin	@ 50 Vin	Min	Nom	Max
MV036F011M100	1/32	100	<b>0.82</b>	<b>1.55</b>	0.5	0.85	1.3
MV036F015M080	1/24	80	<b>1.1</b>	<b>2.0</b>	1.0	1.25	1.5
MV036F022M055	1/16	55	<b>1.63</b>	<b>3.1</b>	1.4	1.75	2.0
MV036F030M040	1/12	40	<b>2.2</b>	<b>4.1</b>	1.45	2.4	3.4
MV036F045M027	1/8	27	<b>3.3</b>	<b>6.2</b>	3.5	5.1	6.6
MV036F060M020	1/6	20	<b>4.3</b>	<b>8.3</b>	5.0	8.0	10
MV036F072M017*	1/5	16.6	<b>6.4*</b>	<b>10</b>	6.0	9.6	12
MV036F090M013	1/4	13.3	<b>6.5</b>	<b>12.5</b>	6.9	9.3	11.6
MV036F120M010	1/3	10.0	<b>8.7</b>	<b>16.6</b>	25	31	35
MV036F180M007	1/2	6.7	<b>13</b>	<b>25</b>	27.5	35.7	46.4
MV036F240M005	2/3	5.0	<b>17.4</b>	<b>33</b>	49.3	70.6	91.8
MV036F360M003	1	3.3	<b>26</b>	<b>50</b>	140	170	200

**Table 1** — VTM part numbers

\* Low line input voltage 32 V

Part Number	Typical Full Load Efficiency at nom Vout (%)	Typical Half Load Efficiency at nom Vout (%)	Maximum Load Capacitance (μF)
MV036F011M100	89.5	91.5	48128
MV036F015M080	92	94	27072
MV036F022M055	94	94.5	12032
MV036F030M040	94	95.0	6768
MV036F045M027	95.3	96.5	3008
MV036F060M020	95.3	96.8	1692
MV036F072M017	96.5	96.5	1175
MV036F090M013	96.3	95.5	752
MV036F120M010	95.5	95.5	423
MV036F180M007	96.0	95.2	188
MV036F240M005	95.0	94.8	106
MV036F360M003	96	96	47

**Table 2** — Typical efficiency and maximum load capacitance, by part number

**Control Pin Functions**

**VC – VTM Control**

The VC port is multiplexed. It receives the initial Vcc voltage from an upstream PRM, synchronizing the output rise of the VTM with the output rise of the PRM. Additionally, the VC port provides feedback to the PRM to compensate for the VTM output resistance. In typical applications using VTMs powered from PRMs, the PRM’s VC port should be connected to the VTM VC port.

In applications where a VTM is being used without a PRM, 14 V must be supplied to the VC port for as long as the input voltage is below 26 V and for 10 ms after the input voltage has reached or exceeded 26 V. The VTM is not designed for extended operation below 26 V. The VC port should only be used to provide Vcc voltage to the VTM during startup.

**PC – Primary Control**

The Primary Control (PC) port is a multifunction port for controlling the VTM as follows:

**Disable** – If PC is left floating, the VTM output is enabled. To disable the output, the PC port must be pulled lower than 2.4 V, referenced to -In. Optocouplers, open collector transistors or relays can be used to control the PC port. Once disabled, 14 V must be re-applied to the VC port to restart the VTM.

**Primary Auxiliary Supply** – The PC port can source up to 2.4 mA at 5 Vdc.

Waveforms

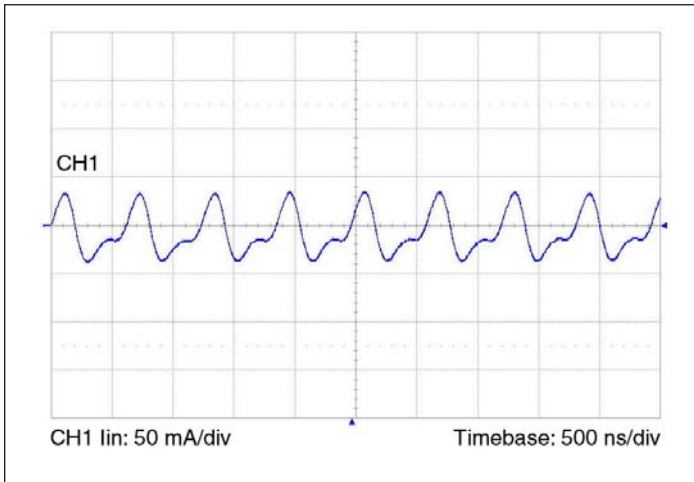

Figure 1 — Representative input reflected ripple current at full load (MV036F120M010).

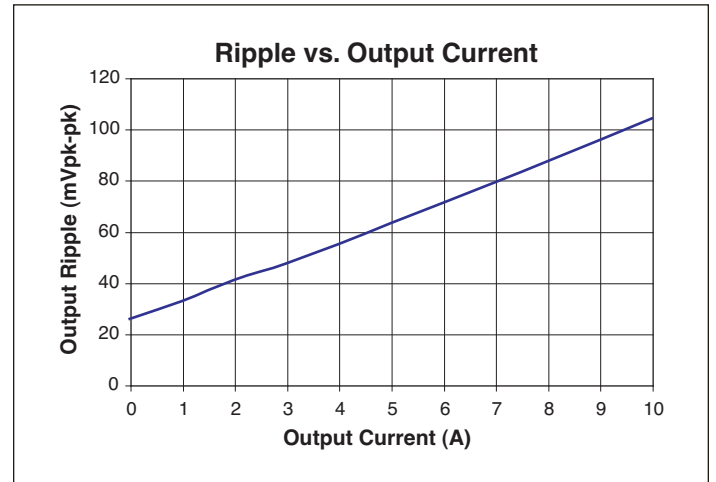

Figure 2 — Sample output voltage ripple vs. output current with no POL bypass capacitance (MV036F120M010).

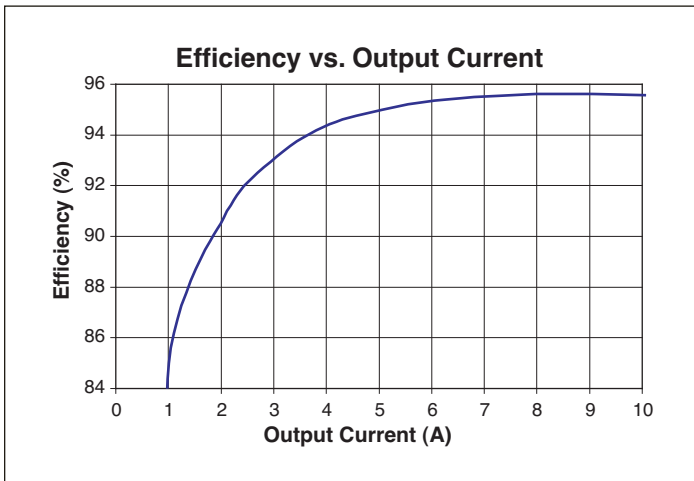

Figure 3 — Representative efficiency vs. output current (MV036F120M010).

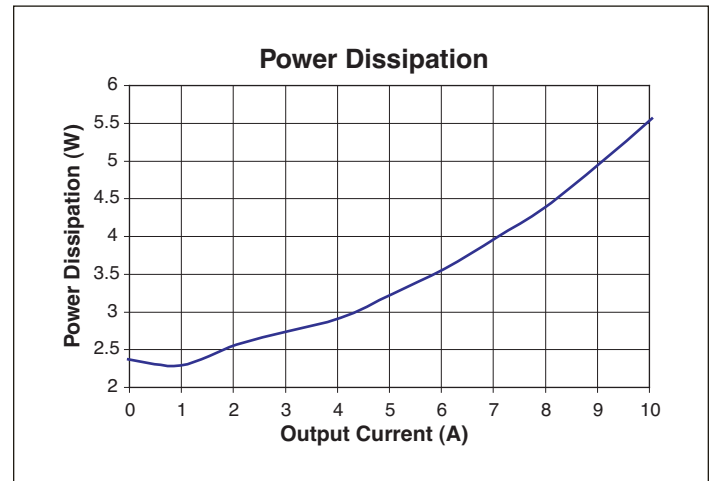

Figure 4 — Example power dissipation vs. output current (MV036F120M010).

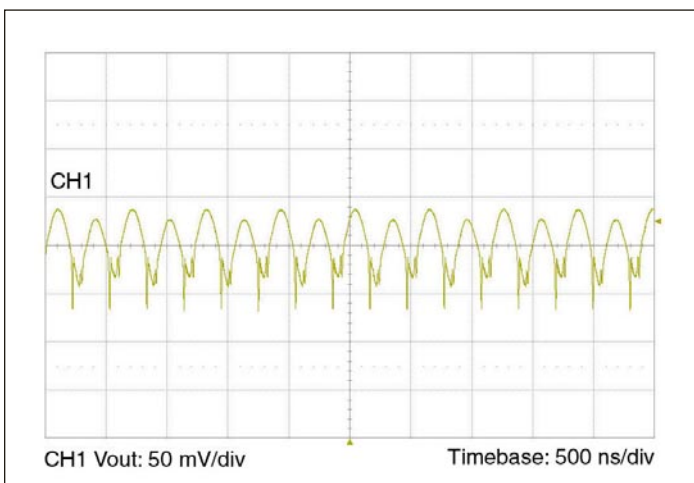

Figure 5 — Sample output voltage ripple at full load; with no POL bypass capacitance (MV036F120M010).

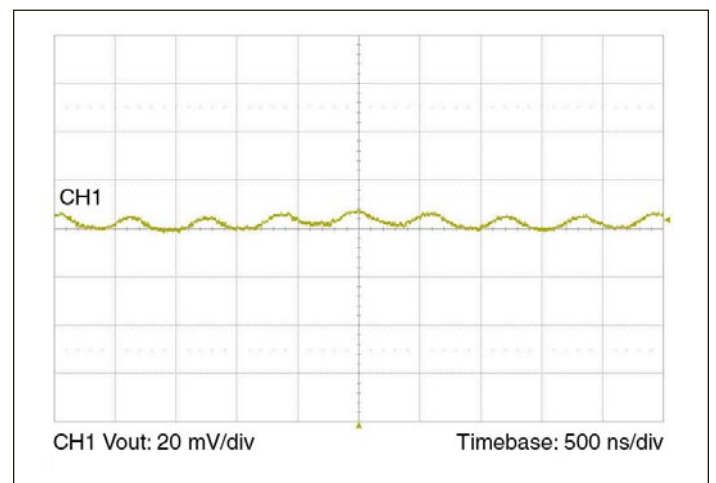
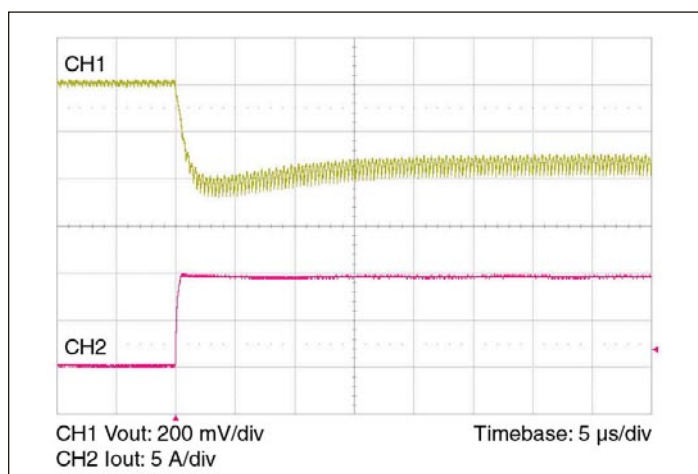
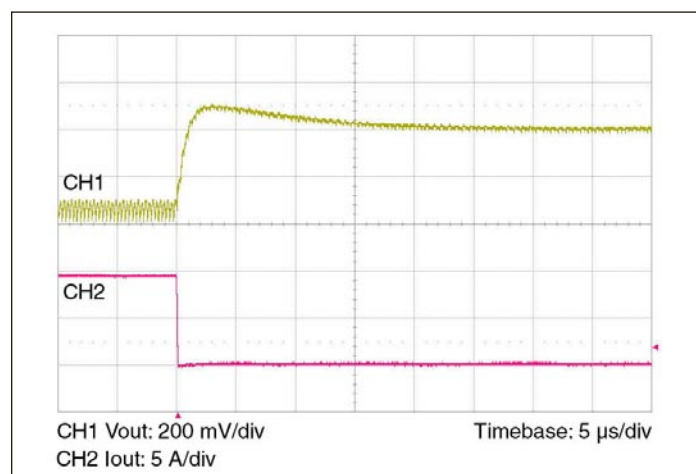

Figure 6 — Sample output voltage ripple at full load with 4.7  $\mu$ F ceramic POL bypass capacitance and 20 nH distribution inductance (MV036F120M010).

## Electrical Specifications (continued)



**Figure 7** — Example load step with 100 μF input capacitance and no output capacitance (MV036F120M010).



**Figure 8** — Example load step with 100 μF input capacitance and no output capacitance (MV036F120M010).

## General

Parameter	Min	Typ	Max	Unit	Note
MTBF (MV036F030M040)					
MIL-HDBK-217F		4,480,000		Hours	25°C, GB
		806,000			50°C NS
		631,000			65°C AIC
Isolation specifications					
Voltage	2,250			Vdc	Input to Output
Capacitance		3000		pF	Input to Output
Resistance	10			MΩ	Input to Output
Agency approvals		cTUVus			UL/CSA 60950-1, EN 60950-1
		CE Mark			Low voltage directive
Mechanical					
Weight		0.53/15		oz/g	See Mechanical Drawings, Figures 10 & 11
Dimensions					
Length		1.28/32,5		in/mm	
Width		0.87/22		in/mm	
Height		0.265/6,73		in/mm	
Thermal					
Over temperature shutdown	125	130	135	°C	Junction temperature
Thermal capacity		9.3		Ws/°C	
Junction-to-case thermal impedance (R <sub>θJC</sub> )		1.1		°C/W	
Junction-to-ambient		5.0		°C/W	With 0.25" heat sink*
Junction-to-board thermal impedance (R <sub>θJB</sub> )		2.1		°C/W	

## Auxiliary Pins (Conditions are at 36 V<sub>in</sub>, full load, and 25°C ambient unless otherwise specified)

Parameter	Min	Typ	Max	Unit	Note
Primary Control (PC)					
DC voltage	4.8	5.0	5.2	Vdc	
Module disable voltage	2.4	2.5		Vdc	
Module enable voltage		2.5	2.6	Vdc	VC voltage must be applied when module is enabled using PC
Current limit	2.4	2.5	2.9	mA	Source only
Disable delay time		6		μs	PC low to Vout low
VTM Control (VC)					
External boost voltage	12	14	19	Vdc	Required for VTM start up without PRM
External boost duration		10		ms	V <sub>in</sub> > 26 Vdc. VC must be applied continuously if V <sub>in</sub> < 26 Vdc.

### +In / -In DC Voltage Ports

The VTM input should not exceed the maximum specified. Be aware of this limit in applications where the VTM is being driven above its nominal output voltage. If less than 26 Vdc is present at the +In and -In ports, a continuous VC voltage must be applied for the VTM to process power. Otherwise VC voltage need only be applied for 10 ms after the voltage at the +In and -In ports has reached or exceeded 26 Vdc. If the input voltage exceeds the overvoltage turn-off, the VTM will shutdown. The VTM does not have internal input reverse polarity protection. Adding a properly sized diode in series with the positive input or a fused reverse-shunt diode will provide reverse polarity protection.

### TM – For Factory Use Only

### VC – VTM Control

The VC port is multiplexed. It receives the initial Vcc voltage from an upstream PRM, synchronizing the output rise of the VTM with the output rise of the PRM. Additionally, the VC port provides feedback to the PRM to compensate for the VTM output resistance. In typical applications using VTMs powered from PRMs, the PRM's VC port should be connected to the VTM VC port.

In applications where a VTM is being used without a PRM, 14 V must be supplied to the VC port for as long as the input voltage is below 26 V and for 10 ms after the input voltage has reached or exceeded 26 V. The VTM is not designed for extended operation below 26 V. The VC port should only be used to provide Vcc voltage to the VTM during startup.

### PC – Primary Control

The Primary Control (PC) port is a multifunction port for controlling the VTM as follows:

**Disable** – If PC is left floating, the VTM output is enabled. To disable the output, the PC port must be pulled lower than 2.4 V, referenced to -In. Optocouplers, open collector transistors or relays can be used to control the PC port. Once disabled, 14 V must be re-applied to the VC port to restart the VTM.

**Primary Auxiliary Supply** – The PC port can source up to 2.4 mA at 5 Vdc.

### +Out / -Out DC Voltage Output Ports

The output and output return are through two sets of contact locations. The respective +Out and -Out groups must be connected in parallel with as low an interconnect resistance as possible.

To take full advantage of the VTM, the user should note the low output impedance of the device. The low output impedance provides fast transient response without the need for bulk POL capacitance. Limited-life electrolytic capacitors required with conventional converters can be reduced or even eliminated, saving cost and valuable board real estate.

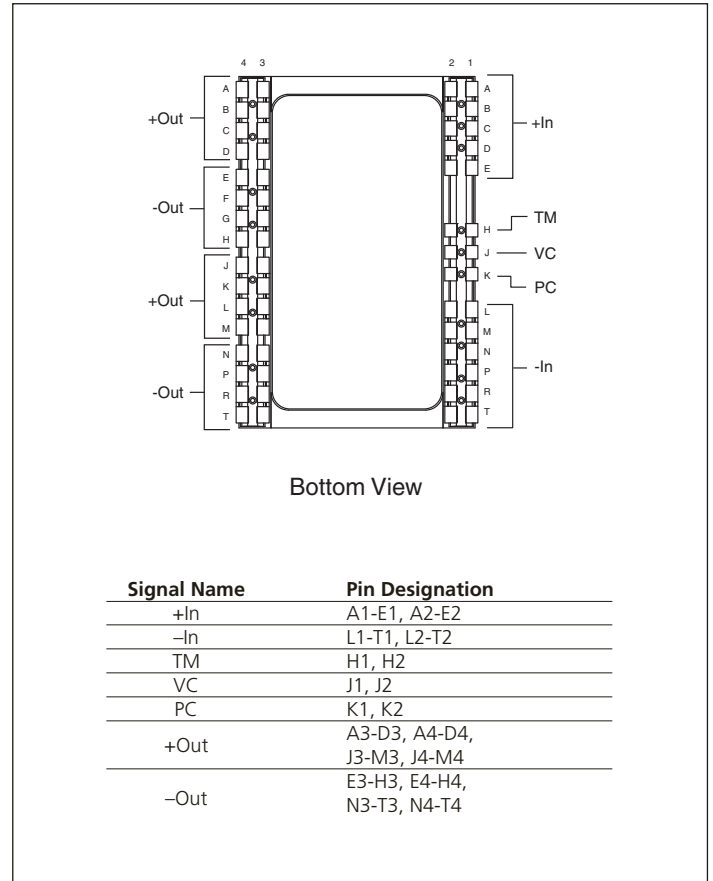

Figure 9 — VTM pin configuration

# Mechanical Drawings

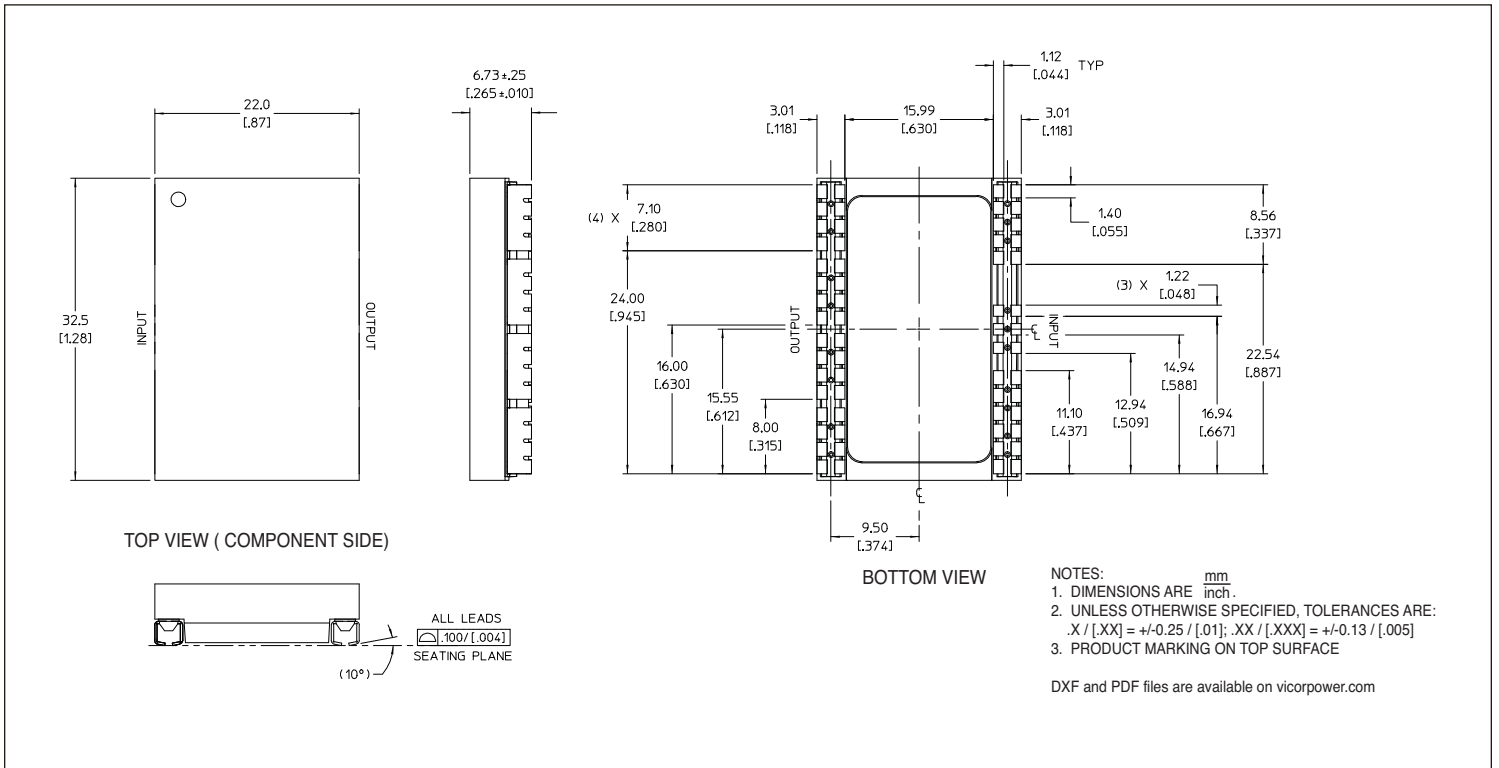

Figure 10 — VTM mechanical outline

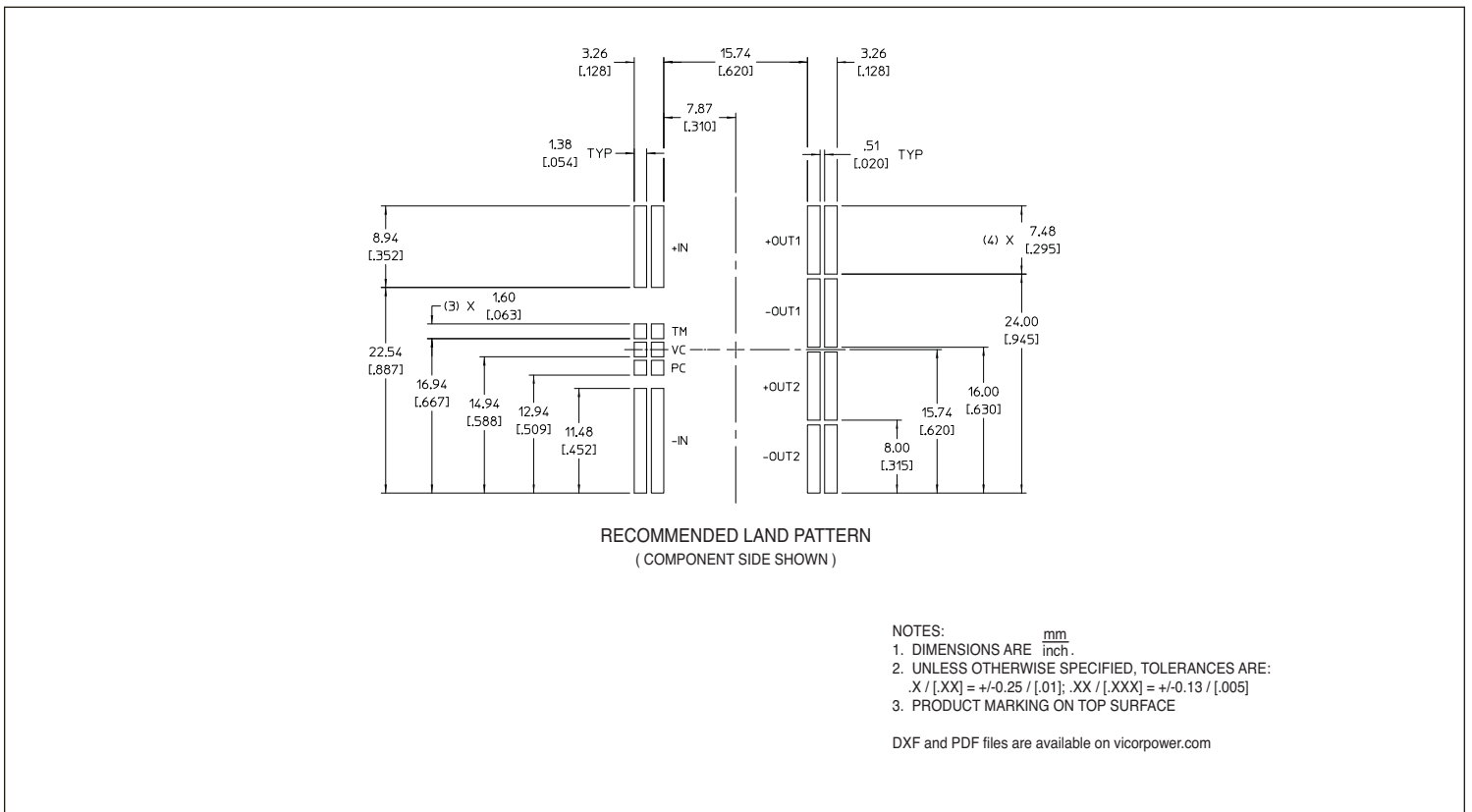

Figure 11 — VTM PCB land layout information

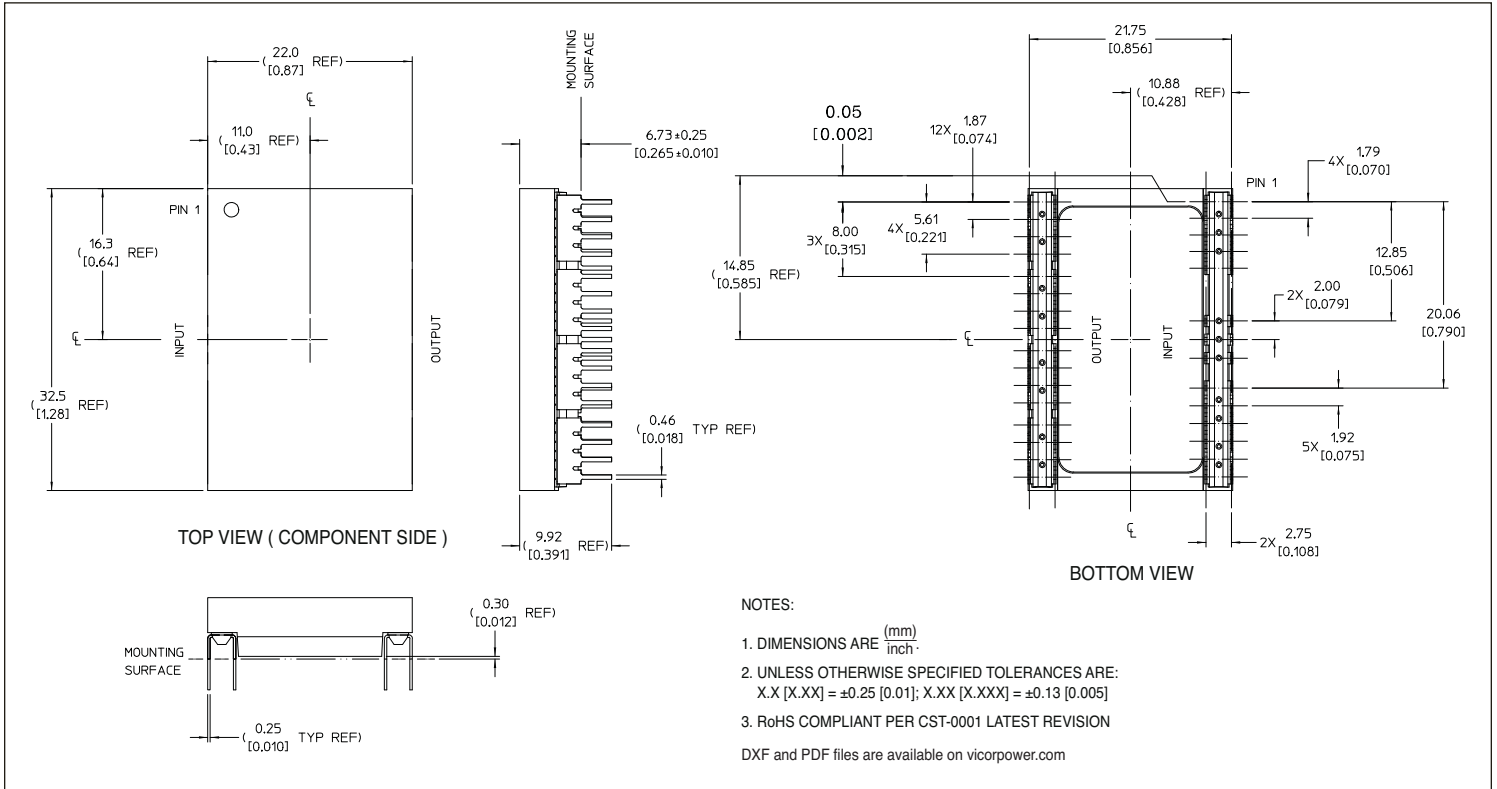

Figure 12 — VTM through-hole mechanical outline

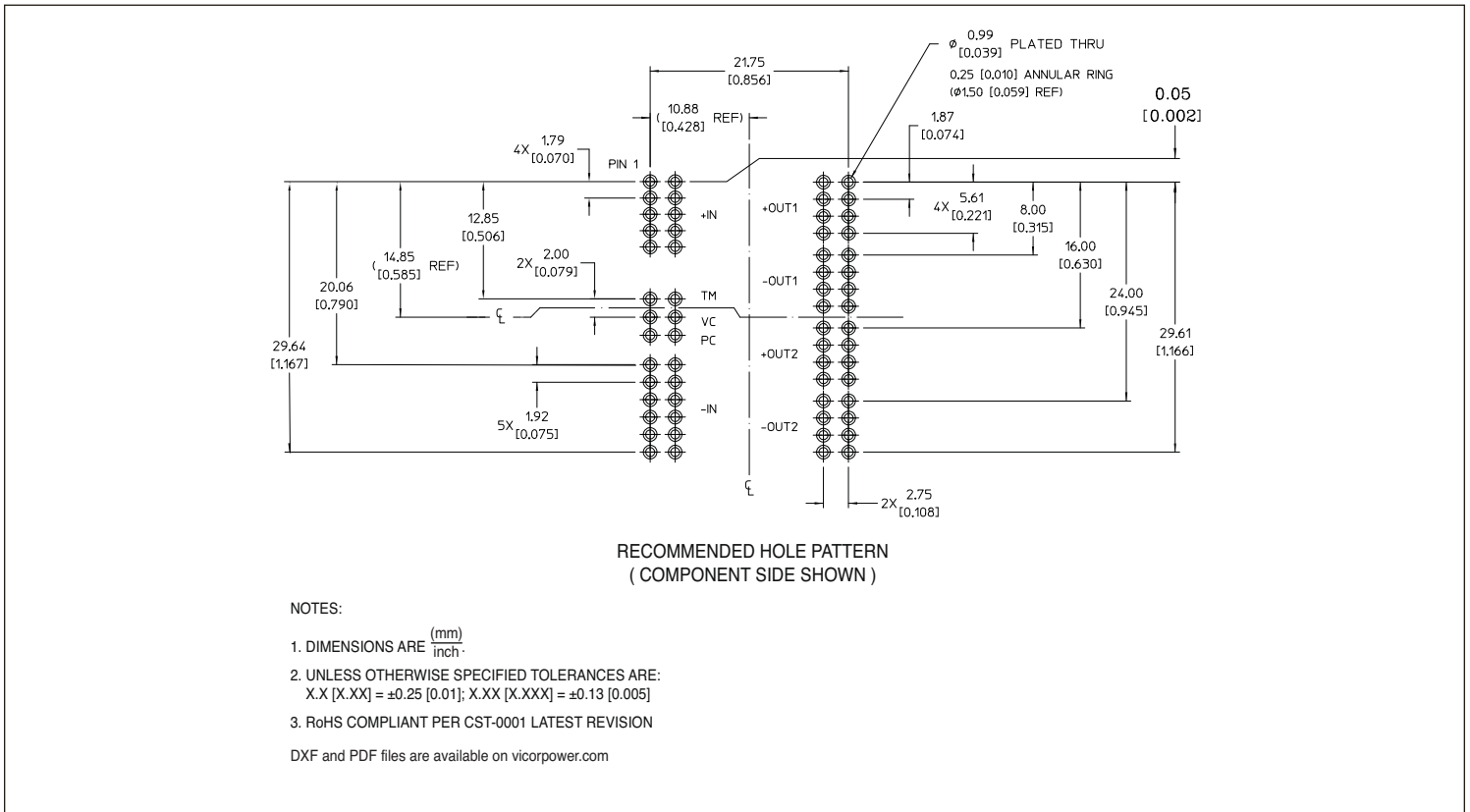
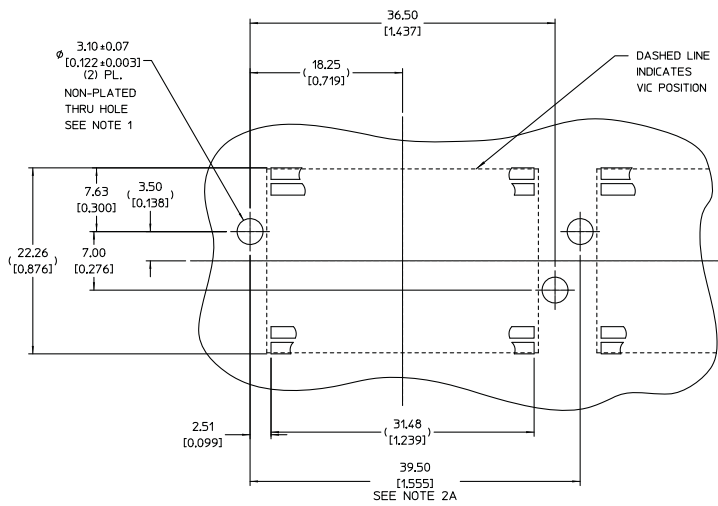

Figure 13 — VTM through-hole PCB layout information



## RECOMMENDED LAND PATTERN (NO GROUNDING CLIPS)

TOP SIDE SHOWN



- NOTES:
1. MAINTAIN 3.50 [0.138] DIA. KEEP-OUT ZONE FREE OF COPPER, ALL PCB LAYERS.
  2. (A) MINIMUM RECOMMENDED PITCH IS 39.50 [1.555], THIS PROVIDES 7.00 [0.275] COMPONENT EDGE-TO-EDGE SPACING, AND 0.50 [0.020] CLEARANCE BETWEEN VICOR HEAT SINKS.  
  
(B) MINIMUM RECOMMENDED PITCH IS 41.00 [1.614], THIS PROVIDES 8.50 [0.334] COMPONENT EDGE-TO-EDGE SPACING, AND 2.00 [0.079] CLEARANCE BETWEEN VICOR HEAT SINKS.

## RECOMMENDED LAND PATTERN (With GROUNDING CLIPS)

TOP SIDE SHOWN

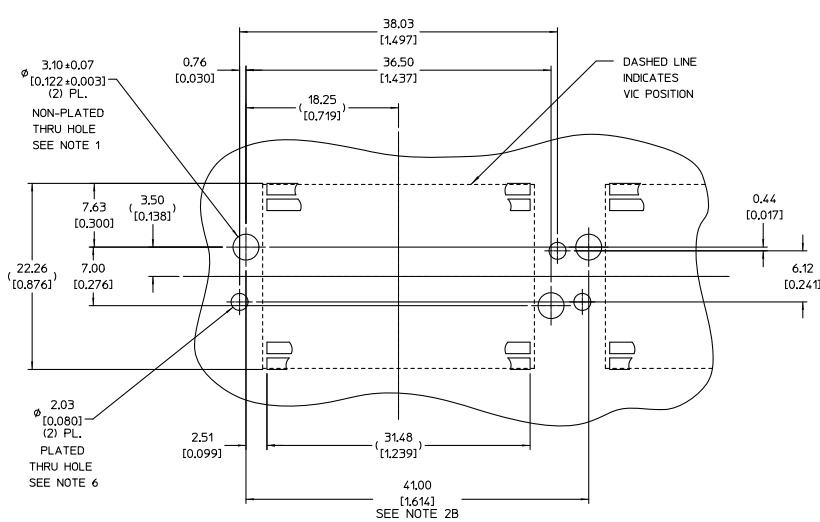

3. V-I CHIP LAND PATTERN SHOWN FOR REFERENCE ONLY; ACTUAL LAND PATTERN MAY DIFFER. DIMENSIONS FROM EDGES OF LAND PATTERN TO PUSH-PIN HOLES WILL BE THE SAME FOR ALL FULL SIZE V-I CHIP PRODUCTS.
4. UNLESS OTHERWISE SPECIFIED: DIMENSIONS ARE MM [INCH]. TOLERANCES ARE:  
X.X [X.XX] = ±0.3 [0.01]  
X.XX [X.XXX] = ±0.13 [0.005]
5. PLATED THROUGH HOLES FOR GROUNDING CLIPS (33855) SHOWN FOR REFERENCE. HEATSINK ORIENTATION AND DEVICE PITCH WILL DICTATE FINAL GROUNDING SOLUTION.

Figure 14 — Hole location for push pin heat sink relative to V-I Chip

## Warranty

Vicor products are guaranteed for two years from date of shipment against defects in material or workmanship when in normal use and service. This warranty does not extend to products subjected to misuse, accident, or improper application or maintenance. Vicor shall not be liable for collateral or consequential damage. This warranty is extended to the original purchaser only.

EXCEPT FOR THE FOREGOING EXPRESS WARRANTY, VICOR MAKES NO WARRANTY, EXPRESS OR IMPLIED, INCLUDING, BUT NOT LIMITED TO, THE WARRANTY OF MERCHANTABILITY OR FITNESS FOR A PARTICULAR PURPOSE.

Vicor will repair or replace defective products in accordance with its own best judgement. For service under this warranty, the buyer must contact Vicor to obtain a Return Material Authorization (RMA) number and shipping instructions. Products returned without prior authorization will be returned to the buyer. The buyer will pay all charges incurred in returning the product to the factory. Vicor will pay all reshipment charges if the product was defective within the terms of this warranty.

Information published by Vicor has been carefully checked and is believed to be accurate; however, no responsibility is assumed for inaccuracies. Vicor reserves the right to make changes to any products without further notice to improve reliability, function, or design. Vicor does not assume any liability arising out of the application or use of any product or circuit; neither does it convey any license under its patent rights nor the rights of others. Vicor general policy does not recommend the use of its components in life support applications wherein a failure or malfunction may directly threaten life or injury. Per Vicor Terms and Conditions of Sale, the user of Vicor components in life support applications assumes all risks of such use and indemnifies Vicor against all damages.

## **Vicor's comprehensive line of power solutions includes high density AC-DC and DC-DC modules and accessory components, fully configurable AC-DC and DC-DC power supplies, and complete custom power systems.**

Information furnished by Vicor is believed to be accurate and reliable. However, no responsibility is assumed by Vicor for its use. Vicor components are not designed to be used in applications, such as life support systems, wherein a failure or malfunction could result in injury or death. All sales are subject to Vicor's Terms and Conditions of Sale, which are available upon request.

## **Specifications are subject to change without notice.**

## Intellectual Property Notice

Vicor and its subsidiaries own Intellectual Property (including issued U.S. and Foreign Patents and pending patent applications) relating to the products described in this data sheet. Interested parties should contact Vicor's Intellectual Property Department.

The products described on this data sheet are protected by the following U.S. Patents Numbers: 5,945,130; 6,403,009; 6,710,257; 6,911,848; 6,930,893; 6,934,166; 6,940,013; 6,969,909; 7,038,917; 7,145,186; 7,166,898; 7,187,263; D496,906; D505,114; D506,438; D509,472; and for use under 6,975,098 and 6,984,965

### **Vicor Corporation**

25 Frontage Road  
Andover, MA, USA 01810  
Tel: 800-735-6200  
Fax: 978-475-6715

### **email**

Customer Service: [custserv@vicorpower.com](mailto:custserv@vicorpower.com)  
Technical Support: [apps@vicorpower.com](mailto:apps@vicorpower.com)