

MXT8208

USB 2.0 FLASH DISK CONTROLLER

Data Sheet

MXT8208

KEY FEATURES



- **USB 2.0 Interface compatible with Mass Storage Device Class**
 - Integrated USB 2.0 PHY
 - Supports USB High Speed and Full Speed
 - Suspend and Resume operations
- **Most Widely FLASH Support**
 - Supports all type of NAND Flash devices ST, Hynix, Samsung, Toshiba, Micron, Infineon and Renesas
 - Supports AND, AG-AND, SuperAND Flash from Renesas
 - Reed-Solomon Encoder/Decoder on-the-fly correction (5 bytes of a 528-byte block)
 - Flash identification support
 - Up to 16MB/s for read and 9MB/s for write operations with single channel
- **Supply Management**
 - Single 5.0V operation
 - Integrated 5.0V-3.3V voltage regulator
 - Integrated 3.3V-1.8V voltage regulator
- **Embedded 8-bit Single Cycle MCU**
 - 80C51 compatible 8-bit Microprocessor
- **USB 2.0 low-power device compliant**
 - Less than 80mA during write operation
 - Less than 500 μ A in suspend mode
- **Clock Management**
 - Integrated PLL for generating core and
 - USB 2.0 clock sources using an external 12 MHz crystal
- **Development support**
 - Complete reference design including schematics, BOM and Gerber files
- **Supports Windows XP, Windows 2K, Windows ME, Linux and MacOS. Drivers available for Windows 98 SE**
- **Abundance GPIO for Application Usage**
 - Up to 28 GPIOs
 - Integrated I²C Logic
 - Integrated UART Logic
- **Flexible Boot Mode Select**
 - Configurable Boot from I²C Logic, IO Logic
- **64BIT Chip ID support**
 - The 64bit Chip ID is unique and can be read out by user for any application purpose
- **Multi-partition support**
 - Each partition can be defined as one of CDROM, HDD, ZIP or Secure-Disk
- **Data Protection**
 - Write protect switch control
 - Public/Private partitions support
- **Design For downgrade FLASH support**
 - Optimized hardware unit for fast and efficiency disk scanning
 - Up to 5bits per 528bytes block ECC of random error
 - Up to 5bytes per 528bytes block ECC of total error

- **Support wear-level arithmetic**
 - **Support bad block dynamic exclusion arithmetic**
 - **Dual-Channel Support for High Speed Application and up to 8 banks FLASH**
 - Up to 18MB/s write and 29MB/s read
 - Up to 12 FLASH chips in series
 - **Support Serial-EEPROM**
 - **Bootability support**
 - Support HDD mode and ZIP mode
 - **Device configurable Parameters :**
 - USB Vendor ID/Product ID (VID/PID), Serial Number and USB strings with foreign language support
 - SCSI strings
 - LED outputs Mode
 - Adjustable Flash bus frequency to reach highest performance
 - **Code update in the Flash or E²PROM**
- **LQFP48 7mmx7mm Lead-Free package**
- **Fabricated in 0.18um CMOS process**

MXT8208

Table of Contents

1 INTRODUCTION	5
2 PIN DESCRIPTION	7
3 APPLICATION SCHEMATICS	10
4 ELECTRICAL CHARACTERISTICS	11
4.1 PARAMETER CONDITIONS	11
4.1.1 Minimum and Maximum values	11
4.1.2 Typical values	11
4.1.3 Typical curves	11
4.1.4 Loading capacitor	11
4.1.5 Pin input voltage	11
4.2 ABSOLUTE MAXIMUM RATINGS	12
4.2.1 Voltage Characteristics	12
4.2.2 Current Characteristics	12
4.2.3 Thermal Characteristics	12
4.3 OPERATING CONDITIONS	13
4.3.1 General Operating Conditions	13
4.4 SUPPLY CURRENT CHARACTERISTICS	13
4.4.1 RUN and SUSPEND Modes	13
4.5 CLOCK AND TIMING CHARACTERISTICS	14
4.5.1 Crystal Oscillator	14
4.6 I/O PORT PIN CHARACTERISTICS	15
4.6.1 General Characteristics	15
4.6.2 USB (Universal Bus Interface)	16
5 PACKAGE MECHANICAL DATA	17
6 DEVICE ORDERING INFORMATION	18

1 INTRODUCTION

The MXT8208 is a USB 2.0 high-speed Flash Drive controller. The USB 2.0 high-speed interface including PHY and function supports USB 2.0 Mass Storage Device Class.

The Mass Storage Controller Interface combined with the Reed-Solomon Encoder/Decoder on-the-fly correction (5-byte on 528-byte data blocks) provides a flexible, high transfer rate solution for interfacing a wide range of Flash memory device types. The internal 60 MHz PLL driven by the 12MHz Oscillator is used to generate the 480MHz frequency for the USB 2.0 PHY.

The Integrated 80C51 MCU runs the application program from the internal ROM and RAM. USB data and patch code are stored in internal RAM.

I/O ports provide functions for EEPROM, LED and write protect switch control. The internal 5.0V to 3.3V and 3.3V to 1.8V voltage regulator provides the 3.3V and 1.8V supply voltage to the digital part of the circuit.

MXT8208 has optimized internal structure and techniques designed special for MLC process. With dual-channel and up to 5bytes ECC support, make MLC present excellence performance as SLC NAND Flash.

MXT8208 supports all the FLASH on the today's market. Include normal SLC/MLC NAND flash, AND/AG-AND and Super-AND flash produced by Renesas, Or-NAND flash produce by Micron. It supports 8bit/16bit bus spec, with big/small or large page type of all kinds of FLASH. With advanced I/O pad process, the controller can support wide I/O voltage range from 1.8V to 3.3V LVCMOS logic.

MXT8208 has a very flexible and configurable interface and internal resource for future FLASH compatible.

MXT8208 supports boot from NAND flash, I²C bus or GPIO logic. Which make support for future flash process be possible. The firmware can be downloaded to NAND flash or E²PROM via on chip bus logic. The boot-loader resided in the inner ROM will load the outer codes if necessary.

The code in the NAND or E²PROM can be used for multi-purpose. For example, implement user-defined functions such as USB finger-scanner, USB-Key and USB-Ad Disk. In such application, mounting E²PROM via On-Chip I²C bus prefer to a NAND flash device.

MXT8208 has a UID generating unit implemented by especial process. Which can generate a Unique Identify Code for each die. The UID is 64bits long and can be read out by private command. The ID can be used for the application that requires high security. For example, finance market, personal identify, high security data storage, protecting your Intellectual Property and so on.

MXT8208 has consider this impenetrate its design cycle. Now our controller has optimized hardware unit for fast and efficiency disk scanning. It provides scan patterns like memory BIST algorithm. And there are several scan pattern can be configured by user. With our special hardware support, the disk scanning will achieved the fastest speed and highest efficiency.

The Controller supports on-chip I²C and UART logic. Together with the C51 compatible MCU core, make it very suitable for value-extended produce. The I²C bus and UART can be interface to many miscellaneous peripherals. The controller also provide up to 28 GPIO . All the GPIO can be programmed to input or output pins respectively, support to interface more I/O devices or user-defined control logic.

Figure 1. Device Block Diagram

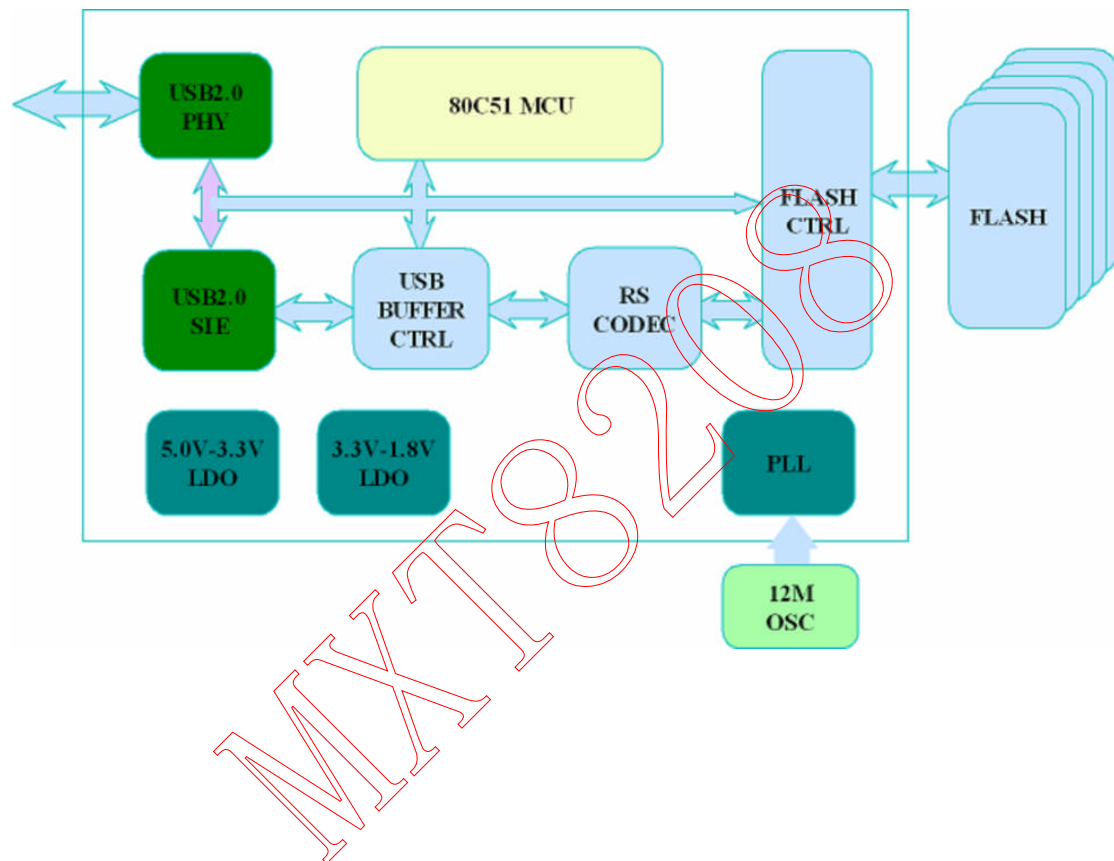

2 PIN DESCRIPTION

Figure 2. 48-Pin TQFP Package Pin-out

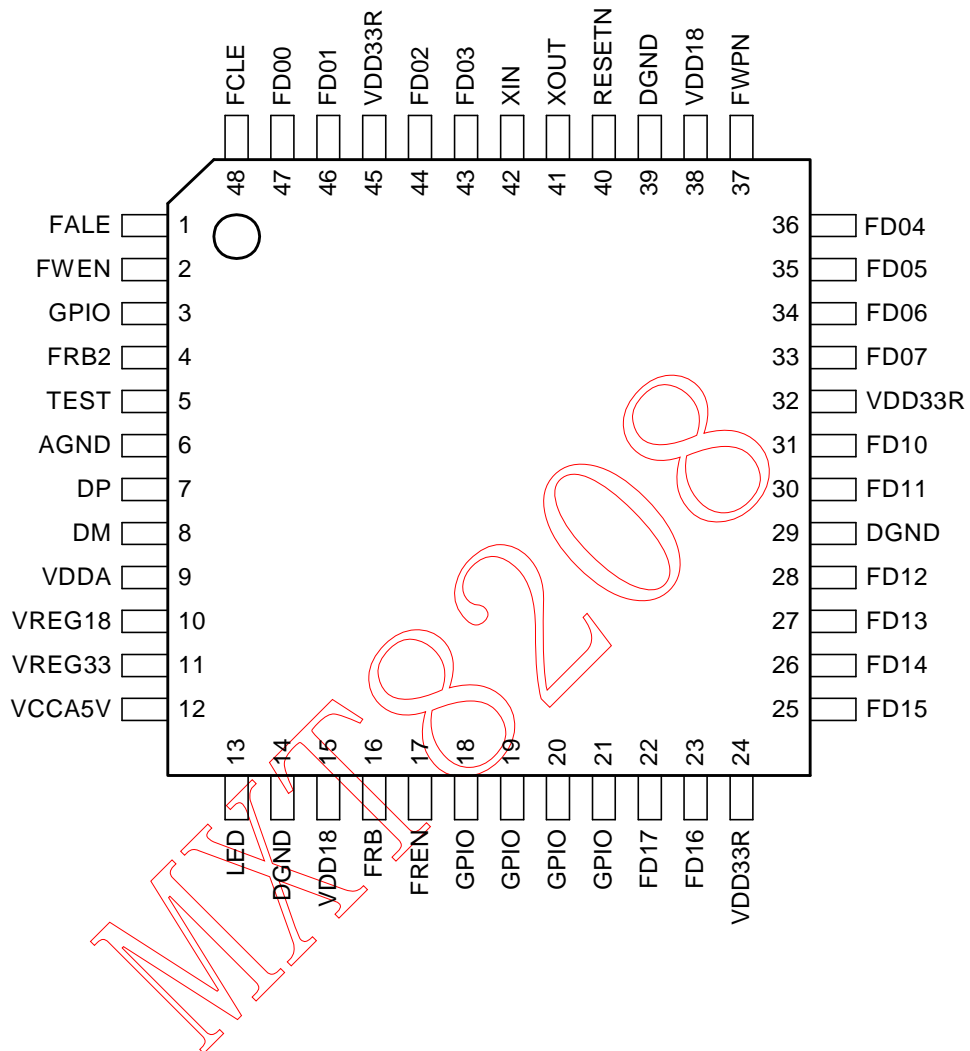

PIN DESCRIPTION (Cont'd) – MXT8208 Compatible

Legend / Abbreviations for tables:

Type: I = input, O = output, S = supply

Input level: A = Dedicated analog input

In/Output level: CT = CMOS 0.3VDD/0.7VDD with input trigger

TT= TTL 0.8V / 2V with Schmitt trigger

Output level:

D8 = 8mA drive

D4 = 4mA drive

D2 = 2mA drive

Table 1. Power Supply

LQFP48 Pin	Pin Name	Type	Description
6	AGND	S	Analog GND for USB PLUG
10	VREG18	S	Internal LDO 1.8V output
9	VDDA	S	Analog Voltage Input 3.3V
11	VREG33	S	Internal LDO 3.3V output
12	VCCA5V	S	Power Supply Input 5.0V (VBUS)
14	DGND	S	Digital Ground
15	VDD18	S	Core Voltage Input 1.8V
24	VDD33R	S	I/O Voltage Input 3.3V
29	DGND	S	Digital Ground
32	VDD33R	S	I/O Voltage Input 3.3V
38	VDD18	S	Core Voltage Input 1.8V
39	DGND	S	Digital Ground
45	VDD33R	S	I/O Voltage Input 3.3V

Table 2. Control & System

LQFP48 Pin	Pin Name	Type	Description
40	RESETN	I	Controller Reset , Low Level Active
5	TEST	I	Test Mode Select
42	XIN	I	12MHz OSC Input
41	XOUT	O	12MHz OSC Output

Table 3. USB 2.0 Interface

LQFP48 Pin	Pin Name	Type	Description
7	DP	I/O	USB2 DATA +
8	DM	I/O	USB2 DATA -

Table 4. General Purpose IO Ports / Mass Storage IOs

LQFP48 Pin	Pin Name	Type	Main Function	Alternate Function
13	LED	O	Bus Transmit LED Driver	
47	FD00	I/O	FLASH Data Bus 0 (Chan.1)	GPIO
46	FD01	I/O	FLASH Data Bus 1 (Chan.1)	GPIO
44	FD02	I/O	FLASH Data Bus 2 (Chan.1)	GPIO
43	FD03	I/O	FLASH Data Bus 3 (Chan.1)	GPIO
36	FD04	I/O	FLASH Data Bus 4 (Chan.1)	GPIO
35	FD05	I/O	FLASH Data Bus 5 (Chan.1)	GPIO
34	FD06	I/O	FLASH Data Bus 6 (Chan.1)	GPIO
33	FD07	I/O	FLASH Data Bus 7 (Chan.1)	GPIO

MXT8208 Datasheet

37	FWPN	O	FLASH Write Protect enable, Active Low	GPIO
2	FWEN	O	FLASH Write Enable	GPIO
1	FALE	O	FLASH Address Latch	GPIO
48	FCLE	O	FLASH Command Latch	GPIO
17	FREN	O	FLASH Read Enable	GPIO
16	FRB	I	FLASH Read/Busy (Chan.1)	GPIO
31	FD10	I/O	FLASH Data Bus 0 (Chan.2)	GPIO
30	FD11	I/O	FLASH Data Bus 1 (Chan.2)	GPIO
28	FD12	I/O	FLASH Data Bus 2 (Chan.2)	GPIO
27	FD13	I/O	FLASH Data Bus 3 (Chan.2)	GPIO
26	FD14	I/O	FLASH Data Bus 4 (Chan.2)	GPIO
25	FD15	I/O	FLASH Data Bus 5 (Chan.2)	GPIO
23	FD16	I/O	FLASH Data Bus 6 (Chan.2)	GPIO
22	FD17	I/O	FLASH Data Bus 7 (Chan.2)	GPIO
4	FRB2	I	FLASH Read/Busy (Chan.2)	GPIO
3	GPIO	I/O		GPIO
18	GPIO	I/O		GPIO
19	GPIO	I/O		GPIO
20	GPIO	I/O		GPIO
21	GPIO	I/O		GPIO

MXT8208

3 APPLICATION SCHEMATICS

Figure 3. Application Schematic Sheet

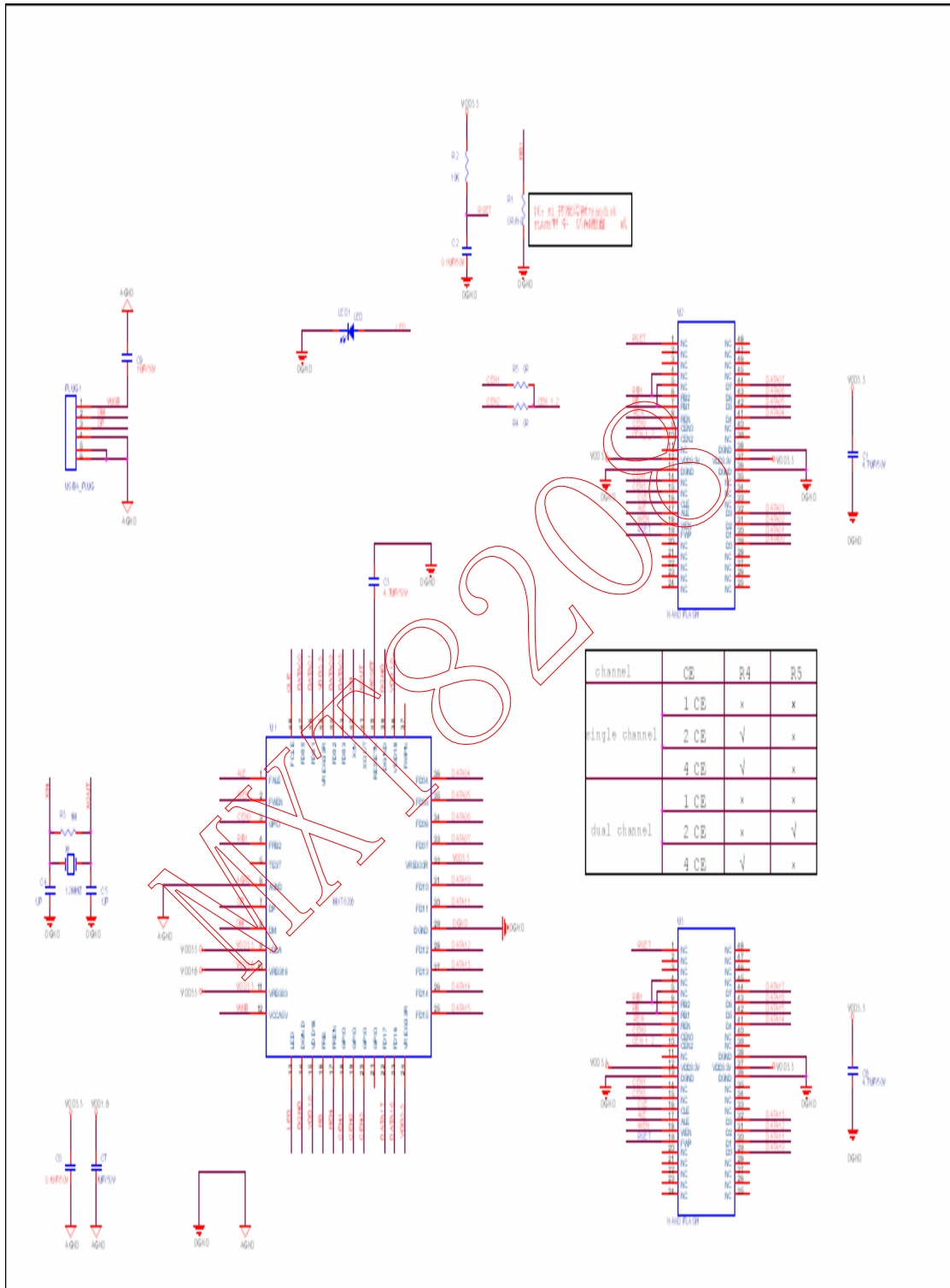

4 ELECTRICAL CHARACTERISTICS

4.1 PARAMETER CONDITIONS

Unless otherwise specified, all voltages are referred to VSS (Digital Ground).

4.1.1 Minimum and Maximum values

Unless otherwise specified the minimum and maximum values are guaranteed in the worst conditions of ambient temperature, supply voltage and frequencies by tests in production on 100% of the Devices with an ambient temperature at $T_A=25^{\circ}\text{C}$ and $T_A=T_{A\text{max}}$ (given by the selected temperature range).

Data based on characterization results, design simulation and/or technology characteristics are indicated in the table footnotes and are not tested in production. Based on characterization, the minimum and maximum values refer to sample tests and represent the mean value plus or minus three times the standard deviation ($\text{mean} \pm 3 \Sigma$).

4.1.2 Typical values

Unless otherwise specified, typical data are based on $T_A=25^{\circ}\text{C}$, $V_{CCA5} = 5.0\text{V}$ or $V_{DD33A}=3.3\text{V}$ with internal LDO bypass. They are given only as design guidelines and are not tested.

4.1.3 Typical curves

Unless otherwise specified, all typical curves are given only as design guidelines and are not tested.

4.1.4 Loading capacitor

The loading conditions used for pin parameter measurement are shown in Figure 4.

Figure 4. Pin loading conditions

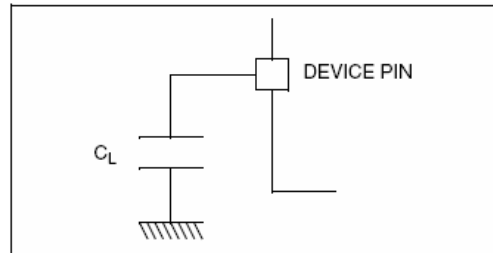

4.1.5 Pin input voltage

The input voltage measurement on a pin of the device is described in Figure 5.

Figure 5. Pin input voltage

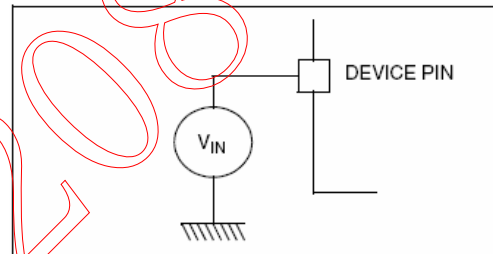

4.2 ABSOLUTE MAXIMUM RATINGS

Stresses above those listed as “absolute maximum ratings” may cause permanent damage to the Device. This is a stress rating only and functional operation of the Device under these conditions is not implied. Exposure to maximum rating conditions for extended periods may affect device reliability.

Table 5

Symbol	Ratings	Max. Value	Unit
VDD33A	Supply Voltage	3.6	V
DP、DM	Input Voltage On Pin	5.5	V
V _{IN}	Input Voltage On other Pin	3.6	V
V _{ESD} (HBM)	ESD for Human Body Mode	2000	V
V _{ESD} (MM)	ESD for Machine Mode	200	V

4.2.1 Voltage Characteristics with internal LDO (VCC = VCCA5 = 5.0V supply)

Table 6

Symbol	Ratings	Max. Value	Unit
VCCA5	Supply Voltage	5.5	V
DP、DM	Input Voltage On Pin	5.5	V
V _{IN}	Input Voltage On other Pin	3.6	V
V _{ESD} (HBM)	ESD for Human Body Mode	2000	V
V _{ESD} (MM)	ESD for Machine Mode	200	V

4.2.2 Current Characteristics (Digital Parts)

Table 7

Symbol	Ratings	Max. Value	Unit
I _{VDD33}	Total Current into VDD33 lines (source)	65	mA
I _{VSS}	Total Current out of VSS ground lines (sink)	65	mA

4.2.3 Thermal Characteristics

Table 8

Symbol	Ratings	Min. Value	Max. Value	Unit
T _{STG}	Storage temperature range	-40	125	°C
T _{OT}	Operating temperature	0	70	°C

4.3 OPERATING CONDITIONS

4.3.1 General Operating Conditions without internal LDO

Table 9

Symbol	Parameter	Conditions	Min	Max	Unit
VDD33	Power Supply		3.0	3.6	V
T _a	Ambient temperature range		0	70	°C

4.3.1 General Operating Conditions with internal LDO

Table 10

Symbol	Parameter	Conditions	Min	Max	Unit
--------	-----------	------------	-----	-----	------

VCCA5	Power Supply		4.5	5.5	V
Ta	Ambient temperature range		0	70	°C

4.4 SUPPLY CURRENT CHARACTERISTICS

4.4.1 RUN and SUSPEND Modes

Table 11

Symbol	Parameter	Conditions	Min	Typ	Max	Unit
I _{DD}	Supply current in RUN mode	fosc = 12M			55	mA
I _{DD}	Supply current in SUSPEND mode	Vreg33=3.3V Ta = +25°C			250	μ A

4.5 CLOCK AND TIMING CHARACTERISTICS

Subject to general operating conditions for VDD33, f_{osc}, and T_A.

4.5.1 Crystal Oscillator

The Device internal clock is supplied from a crystal oscillator. All the information given in this paragraph are based on characterization results with specified typical external components. In the application the load capacitors have to be placed as close as possible to the oscillator pins in order to minimize output distortion and start-up stabilization time. Refer to the crystal manufacturer for more details (frequency, package, accuracy...).

Table 12

Symbol	Parameter	Conditions	Min	Typ	Max	Unit
F _{OSC}	Oscillator frequency			12		Mhz
CK _{ACC}	Total crystal oscillator accuracy	abs. value + temp + ag			±60	Ppm
A _{OSC}	Crystal oscillator duty cycle		45	50	55	%

Figure 6. Typical Application with a Crystal

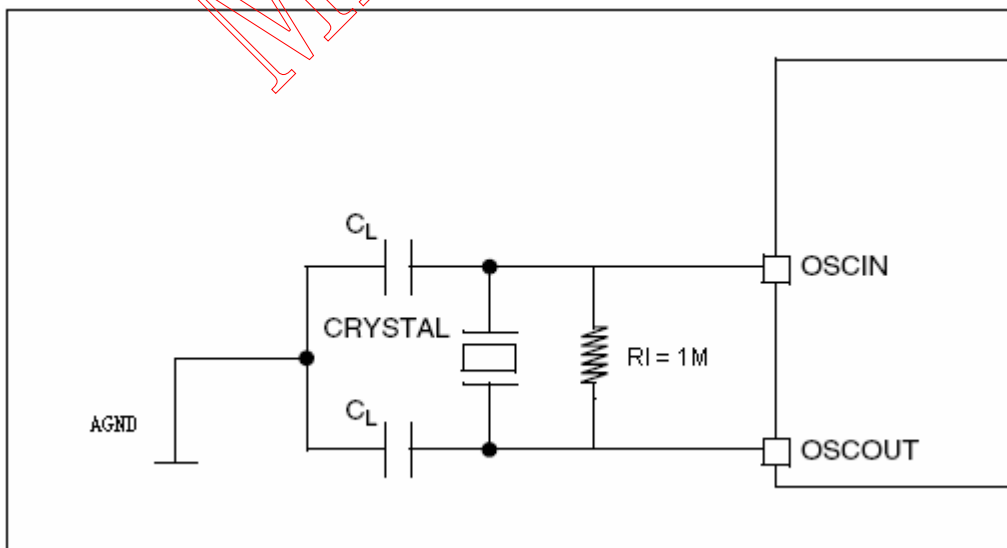

Note

1. The crystal oscillator duty cycle has to be adjusted through the two CL capacitors. Refer to the crystal manufacturer for more details. Typically, $C_L = 12\text{pF}$
2. $R_L = 1\text{M}\Omega$ for matching internal PLL (Opt.)
3. Depending on the crystal power dissipation, a serial resistor R_{Scout} may be added. Refer to the crystal manufacturer for more details. (Opt.)

4.6 I/O PORT PIN CHARACTERISTICS

4.6.1 General Characteristics

Subject to general operating conditions for V_{DD33} , f_{osc} , and T_A unless otherwise specified.

Table 13

Symbol	Parameter	Conditions	Min	Typ	Max	Unit
V_{IL}	Input low level voltage	TTL ports			0.4	V
V_{IH}	Input high level voltage		1.5			V
V_{hys}	Schmitt trigger voltage hysteresis ¹⁾					mV
I_{L}	Input leakage current	$V_{\text{SS}} \leq V_{\text{IN}} \leq V_{\text{DD33}}$, standard I/Os		1		μA
R_{PU}	Weak pull-up equivalent resistor ²⁾	$V_{\text{IN}} = V_{\text{SS}}$ $V_{\text{DD33}} = 3.3\text{V}$	4.7		60	$\text{k}\Omega$

Notes:

1. Hysteresis voltage between Schmitt trigger switching levels. Based on characterization results, not tested in production.
2. The R_{PU} pull-up equivalent resistor is based on a resistive transistor. This data is based on characterization results, tested in production at V_{DD33} max.

Figure 7. Two typical Applications with unused I/O Pin

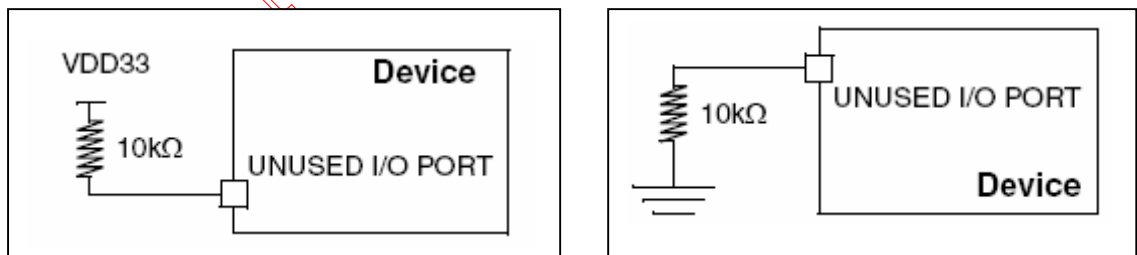

4.6.2 USB (Universal Bus Interface)

Table 14. USB Interface: DC Characteristics

USB DC Electrical Characteristics						
Symbol	Parameter	Conditions	Min.	Typ.	Max.	Unit
$I_{DDsuspend}$	Suspend Current	VDD33=3.3V, regulator ON and PHY OFF	0.2 ¹⁾		0.25 ¹⁾	mA
R_{PU}	Pull-up Resistor ¹⁾		4.7		60	K Ω
Full Speed Mode (DP / DM)						
V_{OH}	High Level Output Voltage			3		V
V_{OL}	Low Level Output Voltage			0.2		V
V_{CRS}	Crossover Voltage		1.4		1.9	V
High Speed Mode (DP / DM)						
V_{HSOH}	HS Data Signalling High			400		mV
V_{HSOL}	HS Data Signalling Low			10		mV

Notes:

1. Not tested in production, guaranteed by characterization.
2. In order to reach this value, the software must force the regulator into power down mode and the I/Os compensation cell off.

Table 15. USB Interface: Timing

USB DC Electrical Characteristics					
Symbol	Parameter	Conditions	Min.	Max.	Unit
Full Speed Mode (DP / DM)					
T_{FR}	Rise Time	$C_L=50pF$	10	15	ns
T_{FF}	Fall Time	$C_L=50pF$	10	15	ns
High Speed Mode (DP / DM)					
T_{HSR}	Rise Time	$R_L=45 \Omega$		500 ¹⁾	ps
T_{HSF}	Fall Time	$R_L=45 \Omega$		500 ¹⁾	ps
T_{HSDRAT}	HS Data Rate			480	Mb/s

Notes:

1. Not tested in production, guaranteed by characterization.

5 PACKAGE MECHANICAL DATA

Figure 8. 48-Pin Thin Quad Flat Package

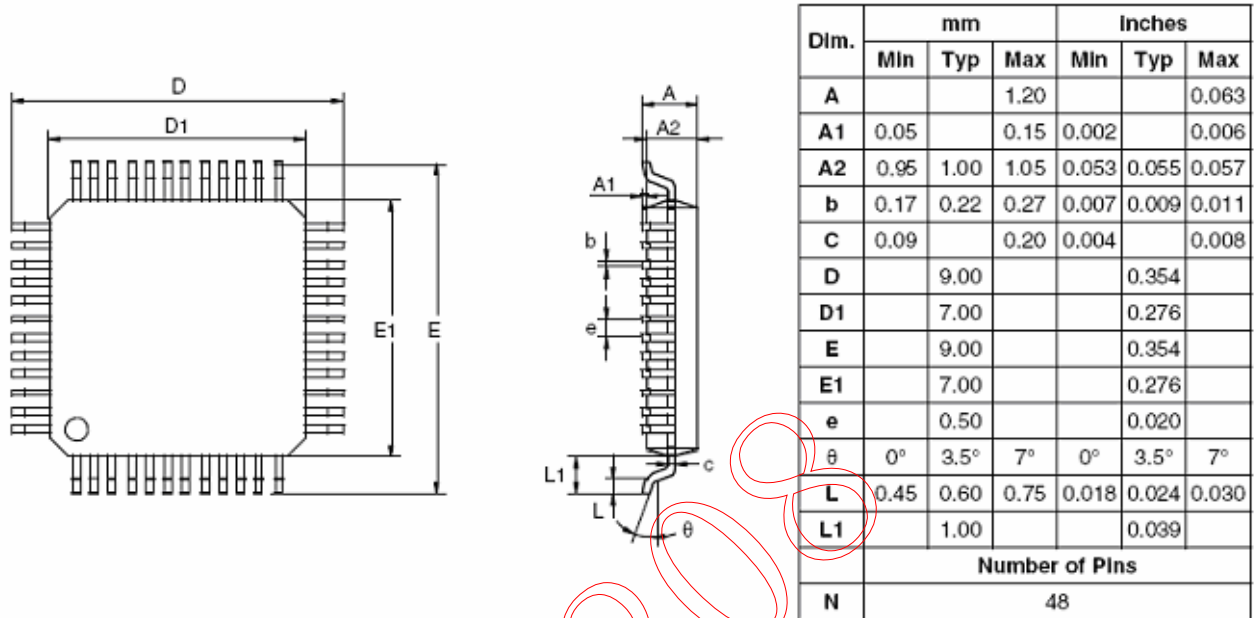

6 DEVICE ORDERING INFORMATION

Table 16. Feature comparison table (sample)

Part Number	Package	Operation Voltage	Temperature Range
MXT8208	LQFP/LQFP48 7mmx7mm	3.0V ~ 3.6V	0°C ~ 70°C

Part Number	Product Info.	Memo
MXT8208	USB2.0 Disk Controller	USB2.0 Mass Storage Disk Controller