

NUF6105FC

6 Channel EMI Pi-Filter Array with ESD Protection

This device is a 6 channel EMI filter array for data lines. Greater than -35 dB attenuation is obtained at frequencies from 800 MHz to 2.2 GHz. It also offers ESD protection – clamping transients from static discharges to protect delicate data line circuitry.

Features

- EMI Filtering and ESD Protection for Data Lines
- Integration of 30 Discretes Offers Cost and Space Savings
- Exceeds IEC61000-4-2 (Level 4) Specifications
- Low Profile Flip-Chip Packaging
- MSL 1
- Pb-Free Package is Available

Typical Applications

- EMI Filtering and ESD Protection for Data Lines
- Cell Phones
- Handheld Portables
- Notebook Computers
- MP3 Players

MAXIMUM RATINGS (T_A = 25°C)

Rating	Symbol	Value	Unit
ESD Discharge IEC61000-4-2, – Air Discharge – Contact Discharge Human Body Model	V _{PP}	30 30 16	kV
DC Power per Resistor	P _R	100	mW
DC Power per Package	P _T	600	mW
Junction Temperature	T _J	150	°C
Operating Temperature Range	T _{op}	-40 to +85	°C
Storage Temperature Range	T _{stg}	-55 to +150	°C

Maximum ratings are those values beyond which device damage can occur. Maximum ratings applied to the device are individual stress limit values (not normal operating conditions) and are not valid simultaneously. If these limits are exceeded, device functional operation is not implied, damage may occur and reliability may be affected.



ON Semiconductor®

<http://onsemi.com>

CIRCUIT DESCRIPTION

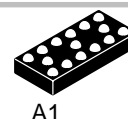
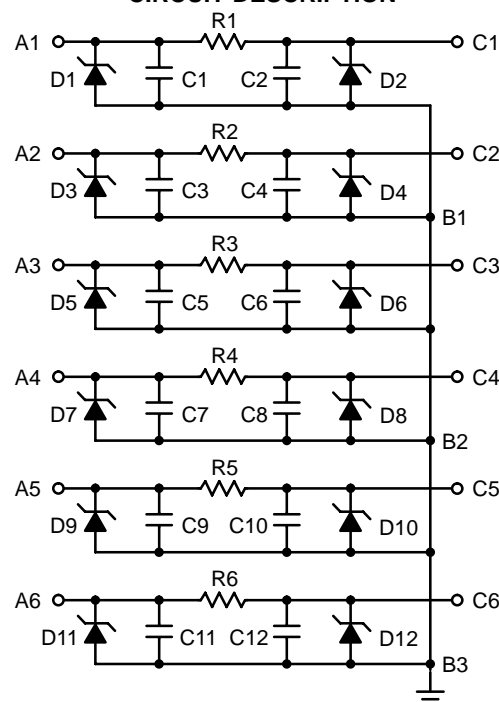

FLIP-CHIP
CASE 499D
PLASTIC

MARKING DIAGRAM

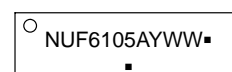

- A = Assembly Location
 - Y = Year
 - WW = Work Week
 - = Pb-Free Package
- (Note: Microdot may be in either location)

ORDERING INFORMATION

Device	Package	Shipping†
NUF6105FCT1	Flip-Chip	3000/Tape & Reel
NUF6105FCT1G	Flip-Chip (Pb-Free)	3000/Tape & Reel

†For information on tape and reel specifications, including part orientation and tape sizes, please refer to our Tape and Reel Packaging Specifications Brochure, BRD8011/D.

NUF6105FC

ELECTRICAL CHARACTERISTICS ($T_A = 25^\circ\text{C}$ unless otherwise noted)

Symbol	Characteristic	Min	Typ	Max	Unit
V_{RWM}	Maximum Reverse Working Voltage	-	-	5.0	V
V_{BR}	$I_Z = 10\text{ mA}$	6.0	7.0	8.0	V
I_R	$V_{RWM} = 3.3\text{ V per line}$	-	-	0.1	μA
$R_{I/O}$	$I_R = 20\text{ mA}$	80	100	120	Ω
C_d	$V_R = 2.5\text{ V, } f = 1\text{ MHz}$ (Note 1 and 2)	-	27	-	pF

1. Measured at 25°C , $V_R = 2.5\text{ V}$, $f = 1.0\text{ MHz}$.
2. Total line capacitance is 2 times the diode capacitance (C_d).

TYPICAL PERFORMANCE CURVES

($T_A = 25^\circ\text{C}$ unless otherwise specified)

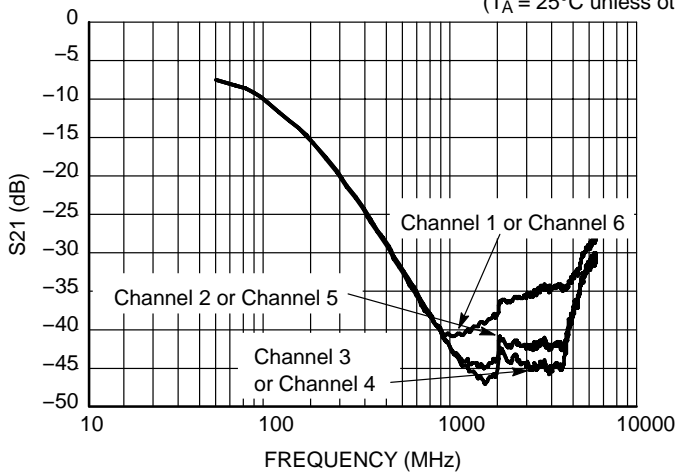

Figure 1. Insertion Loss Curve (S21 Measurement)

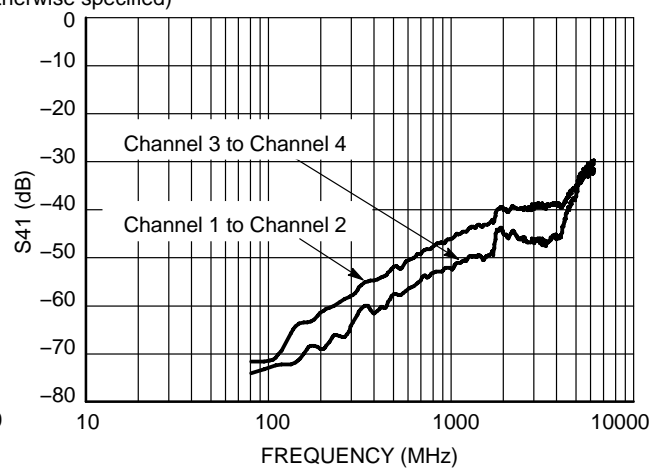

Figure 2. Analog Crosstalk Curve (S41 Measurement)

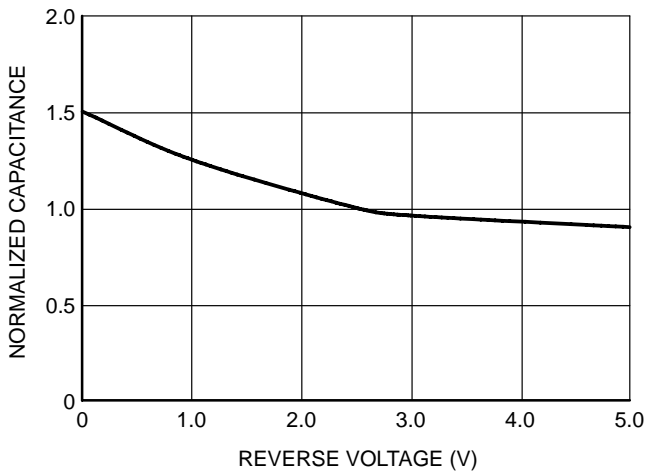

Figure 3. Typical Capacitance vs. Reverse Biased Voltage (Normalized Capacitance C_d at 2.5 V)

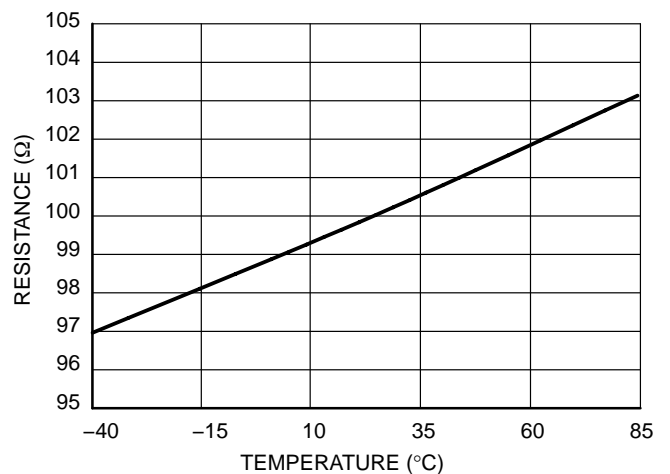

Figure 4. Resistance Over Temperature

NUF6105FC

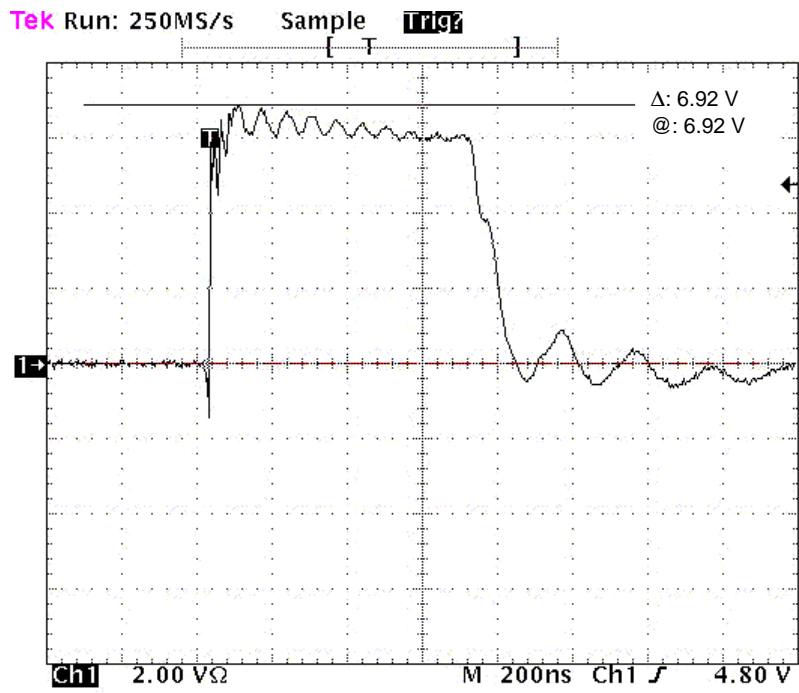

Figure 5. ESD Scope Trace Human Body Model (-8 kV)

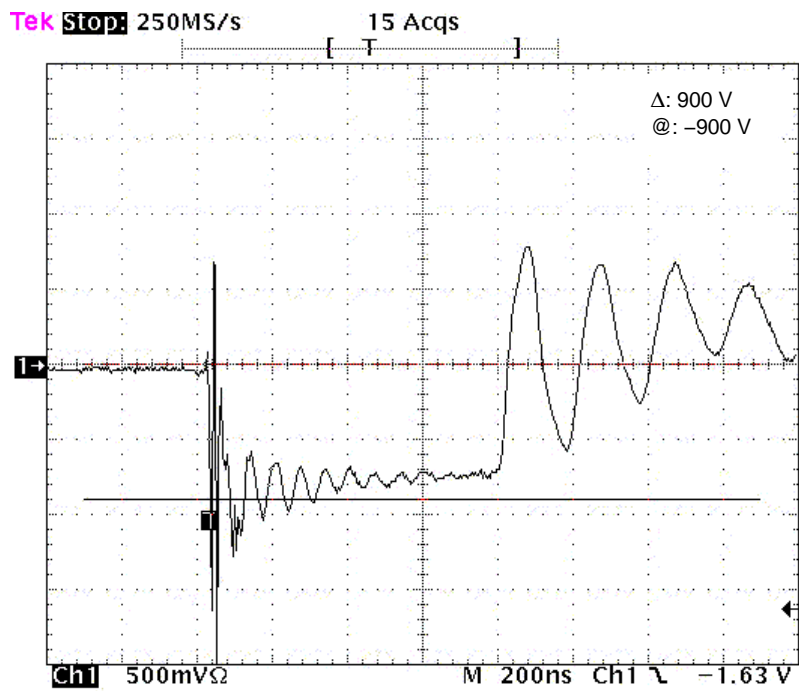

Figure 6. ESD Scope Trace Human Body Model (+8 kV)

NUF6105FC

Printed Circuit Board Recommendations

Parameter	500 μm Pitch 300 μm Solder Ball
PCB Pad Size	250 μm +25 -0
Pad Shape	Round
Pad Type	NSMD
Solder Mask Opening	350 μm \pm 25
Solder Stencil Thickness	125 μm
Stencil Aperture	250 x 250 μm sq.
Solder Flux Ratio	50/50
Solder Paste Type	No Clean Type 3 or Finer
Trace Finish	OSP Cu
Trace Width	150 μm Max

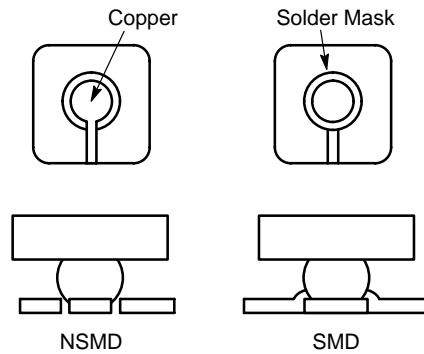

Figure 7. Solder Mask versus Non-Solder Mask Definition

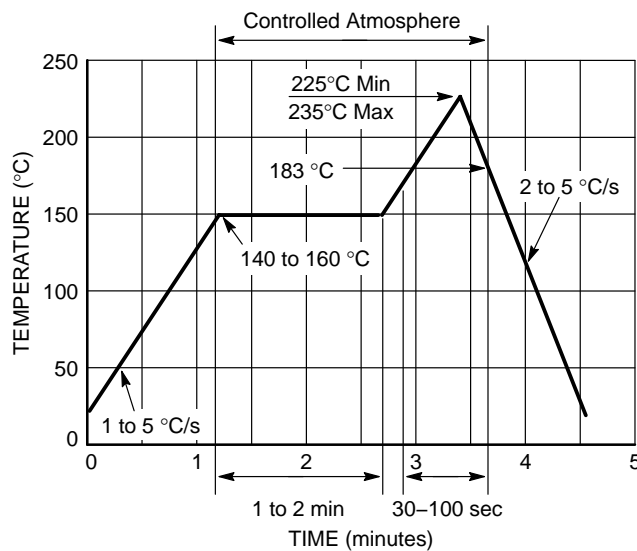
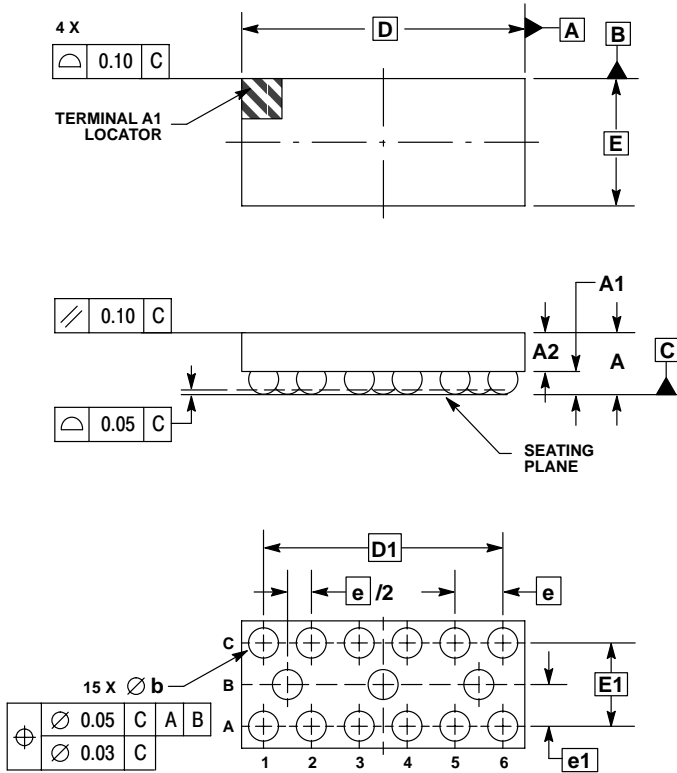

Figure 8. Solder Reflow Profile

NUF6105FC

PACKAGE DIMENSIONS

15 PIN FLIPCHIP CSP
CASE 499D-01
ISSUE O



NOTES:

1. DIMENSIONING AND TOLERANCING PER ASME Y14.5M, 1994.
2. CONTROLLING DIMENSION: MILLIMETER.
3. COPLANARITY APPLIES TO SPHERICAL CROWNS OF SOLDER BALLS.

DIM	MILLIMETERS	
	MIN	MAX
A	---	0.700
A1	0.210	0.270
A2	0.380	0.430
D	2.960 BSC	
E	1.330 BSC	
b	0.290	0.340
e	0.500 BSC	
e1	0.435 BSC	
D1	2.500 BSC	
E1	0.870 BSC	

NUF6105FC

ON Semiconductor and  are registered trademarks of Semiconductor Components Industries, LLC (SCILLC). SCILLC reserves the right to make changes without further notice to any products herein. SCILLC makes no warranty, representation or guarantee regarding the suitability of its products for any particular purpose, nor does SCILLC assume any liability arising out of the application or use of any product or circuit, and specifically disclaims any and all liability, including without limitation special, consequential or incidental damages. "Typical" parameters which may be provided in SCILLC data sheets and/or specifications can and do vary in different applications and actual performance may vary over time. All operating parameters, including "Typicals" must be validated for each customer application by customer's technical experts. SCILLC does not convey any license under its patent rights nor the rights of others. SCILLC products are not designed, intended, or authorized for use as components in systems intended for surgical implant into the body, or other applications intended to support or sustain life, or for any other application in which the failure of the SCILLC product could create a situation where personal injury or death may occur. Should Buyer purchase or use SCILLC products for any such unintended or unauthorized application, Buyer shall indemnify and hold SCILLC and its officers, employees, subsidiaries, affiliates, and distributors harmless against all claims, costs, damages, and expenses, and reasonable attorney fees arising out of, directly or indirectly, any claim of personal injury or death associated with such unintended or unauthorized use, even if such claim alleges that SCILLC was negligent regarding the design or manufacture of the part. SCILLC is an Equal Opportunity/Affirmative Action Employer. This literature is subject to all applicable copyright laws and is not for resale in any manner.

PUBLICATION ORDERING INFORMATION

LITERATURE FULFILLMENT:

Literature Distribution Center for ON Semiconductor
P.O. Box 61312, Phoenix, Arizona 85082-1312 USA
Phone: 480-829-7710 or 800-344-3860 Toll Free USA/Canada
Fax: 480-829-7709 or 800-344-3867 Toll Free USA/Canada
Email: orderlit@onsemi.com

N. American Technical Support: 800-282-9855 Toll Free
USA/Canada

Japan: ON Semiconductor, Japan Customer Focus Center
2-9-1 Kamimeguro, Meguro-ku, Tokyo, Japan 153-0051
Phone: 81-3-5773-3850

ON Semiconductor Website: <http://onsemi.com>

Order Literature: <http://www.onsemi.com/litorder>

For additional information, please contact your
local Sales Representative.

NUF6105FC/D