ZRB500

Precision 5V micropower voltage reference

Description

The ZRB500 uses a bandgap circuit design to achieve a precision micropower voltage reference of 5.0 volts. The device is available in small outline surface mount packages, ideal for applications where space saving is important, as well as packages for through hole requirements.

The ZRB500 design provides a stable voltage without an external capacitor and is stable with capacitive loads. The ZRB500 is recommended for operation between 50 μ A and 15mA and so is ideally suited to low power and battery powered applications.

Features

- $\pm 3\%$, 2% and 1% tolerance
- Operating current 50 μ A to 15mA
- Typical T_C 15ppm/ $^{\circ}$ C
- Transient response, stable in less than 10 μ s
- Industrial temperature range
- Small outline SOT23 and TO92 style packages

Excellent performance is maintained to an absolute maximum of 25mA, however the rugged design and 20 volt processing allows the reference to withstand transient effects and currents up to 200mA. Superior switching capability allows the device to reach stable operating conditions in only a few microseconds.

Applications

- Battery powered and portable equipment
- Metering and measurement systems
- Instrumentation
- Test equipment
- Data acquisition systems
- Precision power supplies

Typical application circuit

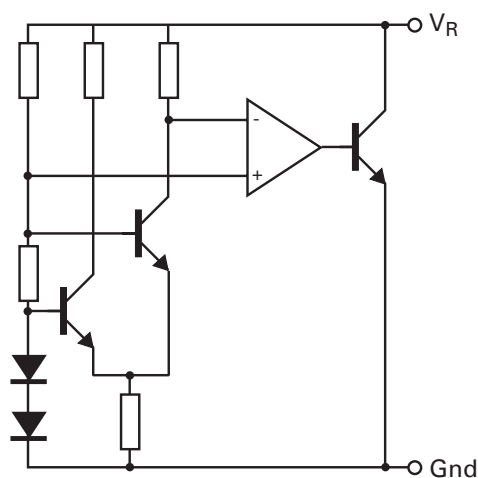

Connection diagrams

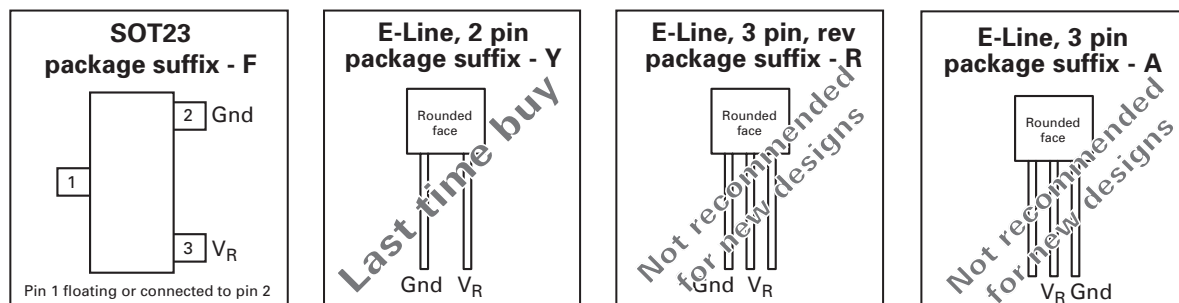

Ordering information

Order reference	Tol. (%)	Device mark	Status (*)	Reel size (inches)	Quantity per reel	Tape width (mm)
ZRB500A01	1	ZRB50001	NRND	Loose	4,000	-
ZRB500A01STOA	1	ZRB50001	NRND	12.5	2,000	-
ZRB500A01STOB	1	ZRB50001	NRND	12.5	2,000	-
ZRB500A01STZ	1	ZRB50001	NRND	Concertina pack	2,000	-
ZRB500A02	2	ZRB50002	NRND	Loose	4,000	-
ZRB500A02STOA	2	ZRB50002	NRND	12.5	2,000	-
ZRB500A02STOB	2	ZRB50002	NRND	12.5	2,000	-
ZRB500A02STZ	2	ZRB50002	NRND	Concertina pack	2,000	-
ZRB500A03	3	ZRB50003	NRND	Loose	4,000	-
ZRB500A03STOA	3	ZRB50003	NRND	12.5	2,000	-
ZRB500A03STOB	3	ZRB50003	NRND	12.5	2,000	-
ZRB500A03STZ	3	ZRB50003	NRND	Concertina pack	2,000	-
ZRB500F01TA	1	50I	REL	7	3,000	8
ZRB500F01TC	1	50I	REL	13	10,000	8
ZRB500F02TA	2	50H	REL	7	3,000	8
ZRB500F02TC	2	50H	REL	13	10,000	8
ZRB500F03TA	3	50G	REL	7	3,000	8
ZRB500F03TC	3	50G	REL	13	10,000	8
ZRB500R01	1	ZRB500R1	NRND	Loose	4,000	-
ZRB500R01STOA	1	ZRB500R1	NRND	12.5	2,000	-
ZRB500R01STOB	1	ZRB500R1	NRND	12.5	2,000	-
ZRB500R01STZ	1	ZRB500R1	NRND	Concertina pack	2,000	-
ZRB500R02	2	ZRB500R2	NRND	Loose	4,000	-
ZRB500R02STOA	2	ZRB500R2	NRND	12.5	2,000	-
ZRB500R02STOB	2	ZRB500R2	NRND	12.5	2,000	-
ZRB500R02STZ	2	ZRB500R2	NRND	Concertina pack	2,000	-
ZRB500R03	3	ZRB500R3	NRND	Loose	4,000	-
ZRB500R03STOA	3	ZRB500R3	NRND	12.5	2,000	-

ZRB500

Ordering information

Order reference	Tol. (%)	Device mark	Status (*)	Reel size (inches)	Quantity per reel	Tape width (mm)
ZRB500R03STOB	3	ZRB500R3	NRND	12.5	2,000	-
ZRB500R03STZ	3	ZRB500R3	NRND	Concertina pack	2,000	-
ZRB500Y01	1	ZRB50001	LTB	Loose	4,000	-
ZRB500Y01STOA	1	ZRB50001	LTB	12.5	2,000	-
ZRB500Y01STOB	1	ZRB50001	LTB	12.5	2,000	-
ZRB500Y01STZ	1	ZRB50001	LTB	Concertina pack	2,000	-
ZRB500Y02	1	ZRB50002	LTB	Loose	4,000	-
ZRB500Y02STOA	2	ZRB50002	LTB	12.5	2,000	-
ZRB500Y02STOB	2	ZRB50002	LTB	12.5	2,000	-
ZRB500Y02STZ	2	ZRB50002	LTB	Concertina pack	2,000	-
ZRB500Y03	3	ZRB50003	LTB	Loose	4,000	-
ZRB500Y03STOA	3	ZRB50003	LTB	12.5	2,000	-
ZRB500Y03STOB	3	ZRC50003	LTB	12.5	2,000	-
ZRB500Y03STZ	3	ZRC50003	LTB	Concertina pack	2,000	-

NOTES:

(*) NRND Not recommended for new designs
REL Released
LTB Last time buy

Absolute maximum rating

Reverse current	25mA	Power dissipation ($T_{amb} = 25^{\circ}\text{C}$)	
Forward current	25mA	SOT23	330mW
Operating temperature	-40 to 85°C		
Storage temperature	-55 to 125°C		

Electrical characteristics. Test conditions (unless otherwise stated) $T_{amb} = 25^{\circ}\text{C}$

Symbol	Parameter	Conditions	Limits			Tol. (%)	Units
			Min.	Typ.	Max.		
V_R	Reverse breakdown voltage	$I_R = 150\mu\text{A}$	4.95	5.0	5.05	1	V
			4.90	5.0	5.10	2	V
			4.85	5.0	5.15	3	V
I_{MIN}	Minimum operating current			30	50		μA
I_R	Recommended operating current		0.05		15		mA
$T_C^{(*)}$	Average reverse breakdown voltage temperature coefficient	$I_{R(min)}$ to $I_{R(max)}$		15	50		ppm/ $^{\circ}\text{C}$
$R_S^{(t)}$	Slope resistance			0.33	1.5		Ω
Z_R	Reverse dynamic impedance	$I_R = 1\text{mA}$ $f = 100\text{Hz}$ $I_{AC} = 0.1I_R$		0.4	1		Ω
E_N	Wideband noise voltage	$I_R = 150\mu\text{A}$ $f = 10\text{Hz to } 10\text{kHz}$		105			$\mu\text{V(rms)}$

NOTES:

$$(*) T_C = \frac{(V_{R(max)} - V_{R(min)}) \times 1000000}{V_R \times (T_{(max)} - T_{(min)})}$$

Note: $V_{R(max)} - V_{R(min)}$ is the maximum deviation in reference voltage measured over the full operating temperature range.

$$(t) R_S = \frac{V_R \text{ Change}(I_{R(min)} \text{ to } I_{R(max)})}{I_{R(max)} - I_{R(min)}}$$

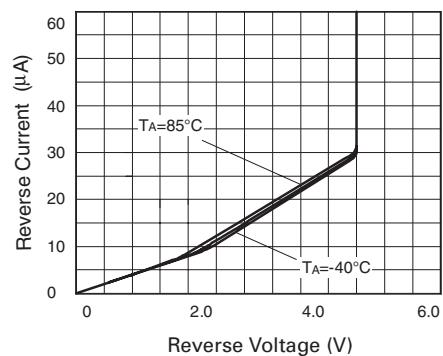

Reverse Characteristics

Typical characteristics

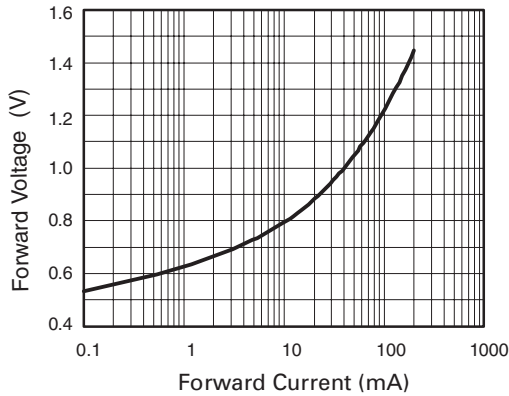

Forward Characteristics

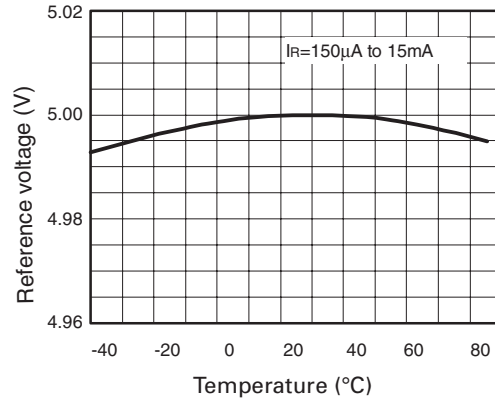

Temperature Drift

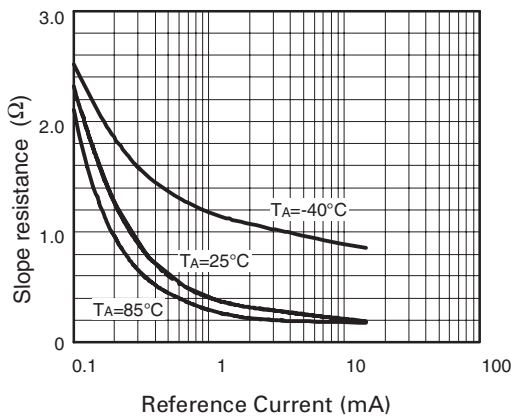

Slope Resistance v Current

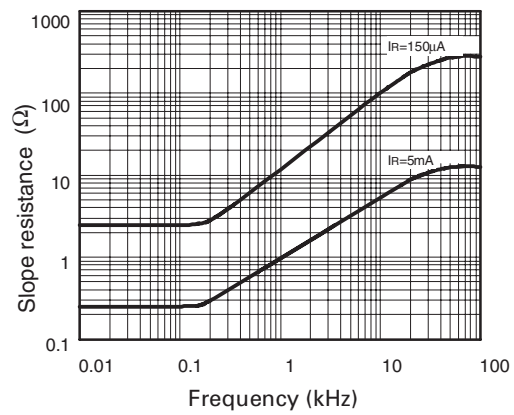

Slope Resistance v Frequency

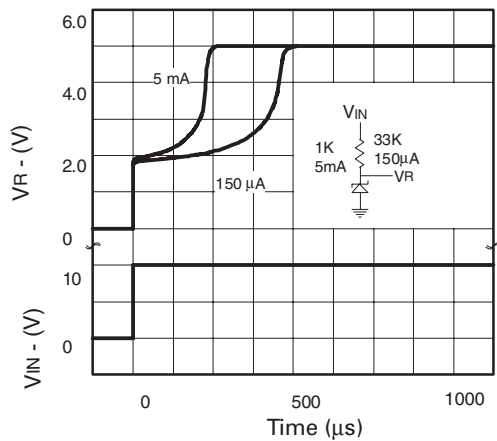

**Transient Response
(Single Pulse)**

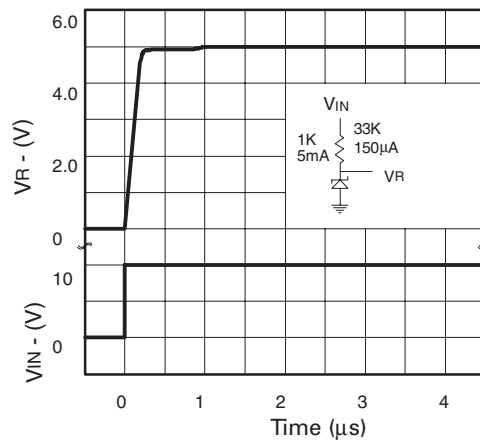

**Transient Response
(Repetitive Pulse)**

Package outline - SOT23

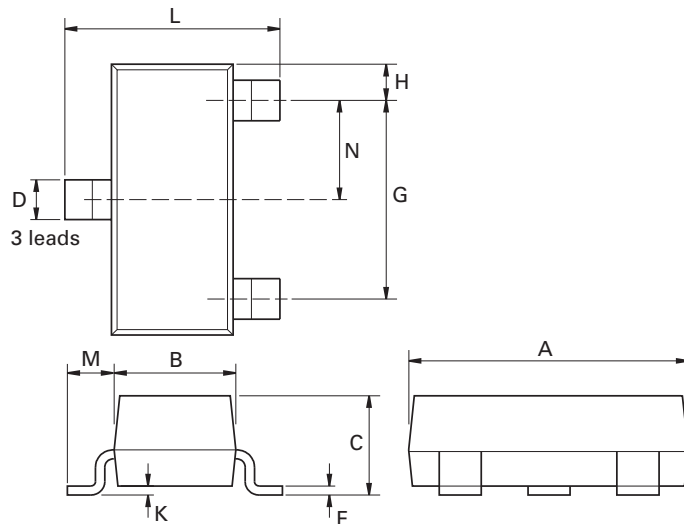

Dim.	Millimeters		Inches		Dim.	Millimeters		Inches	
	Min.	Max.	Min.	Max.		Min.	Max.	Max.	Max.
A	2.67	3.05	0.105	0.120	H	0.33	0.51	0.013	0.020
B	1.20	1.40	0.047	0.055	K	0.01	0.10	0.0004	0.004
C	-	1.10	-	0.043	L	2.10	2.50	0.083	0.0985
D	0.37	0.53	0.015	0.021	M	0.45	0.64	0.018	0.025
F	0.085	0.15	0.0034	0.0059	N	0.95 NOM		0.0375 NOM	
G	1.90 NOM		0.075 NOM		-	-	-	-	-

Note: Controlling dimensions are in millimeters. Approximate dimensions are provided in inch

ZRB500

Package outline - E-Line, 2 pin

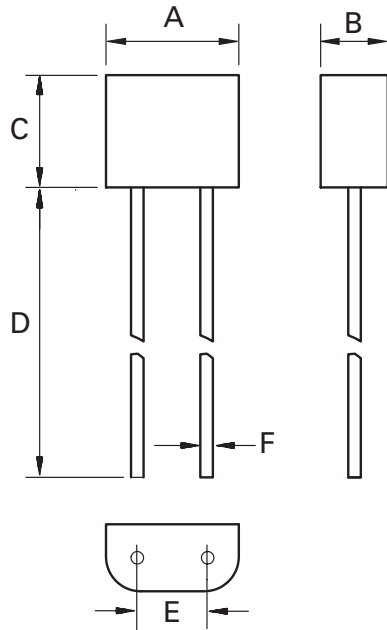

DIM	Millimeters		Inches	
	Min.	Max.	Min.	Max.
A	4.37	4.77	0.17	0.18
B	2.16	2.41	0.085	0.095
C	3.61	4.01	0.14	0.16
D	13.00	13.97	0.51	0.55
E	2.54 NOM		0.10 NOM	
F	0.37	0.495	0.015	0.019

Note: Controlling dimensions are in millimeters. Approximate dimensions are provided in inches

Package outline - E-Line, 3 pin, rev.

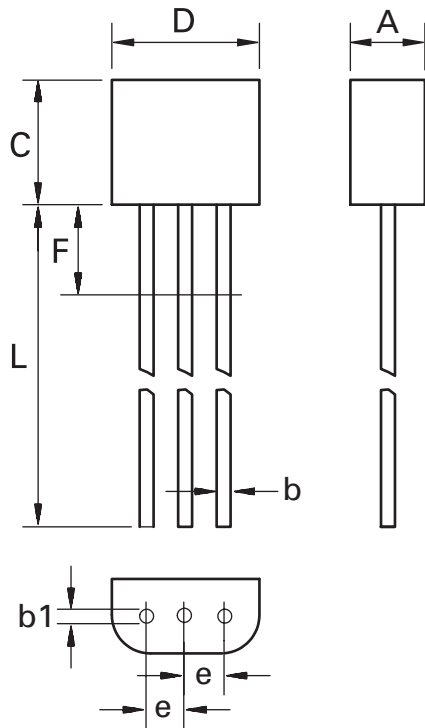

DIM	Millimeters		Inches	
	Min.	Max.	Min.	Max.
A	2.16	2.41	0.085	0.095
b	0.41	0.495	0.016	0.0195
b1	0.41	0.495	0.016	0.0195
D	4.37	4.77	0.172	0.188
E	3.61	4.01	0.142	0.158
e	1.27 NOM		0.050 NOM	
F	—	2.50	—	0.098
L	13.00	13.97	0.512	0.550

Note: Controlling dimensions are in millimeters. Approximate dimensions are provided in inches

Package outline - E-Line, 3 pin

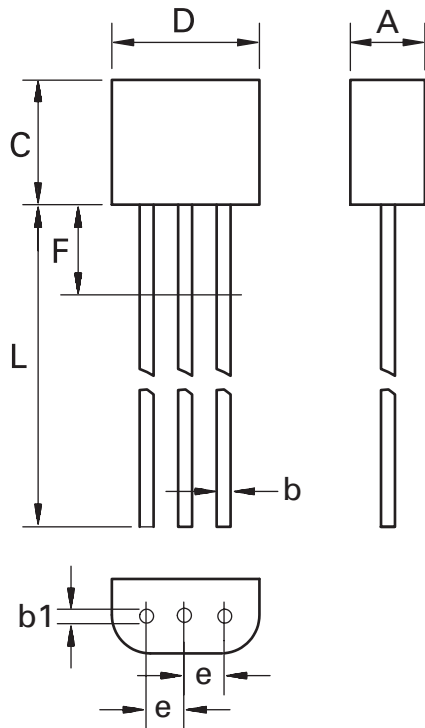

DIM	Millimeters		Inches	
	Min.	Max.	Min.	Max.
A	2.16	2.41	0.085	0.095
b	0.41	0.495	0.016	0.0195
b1	0.41	0.495	0.016	0.0195
D	4.37	4.77	0.172	0.188
E	3.61	4.01	0.142	0.158
e	1.27 NOM		0.050 NOM	
F	—	2.50	—	0.098
L	13.00	13.97	0.512	0.550

Note: Controlling dimensions are in millimeters. Approximate dimensions are provided in inches

Package outline - SO8

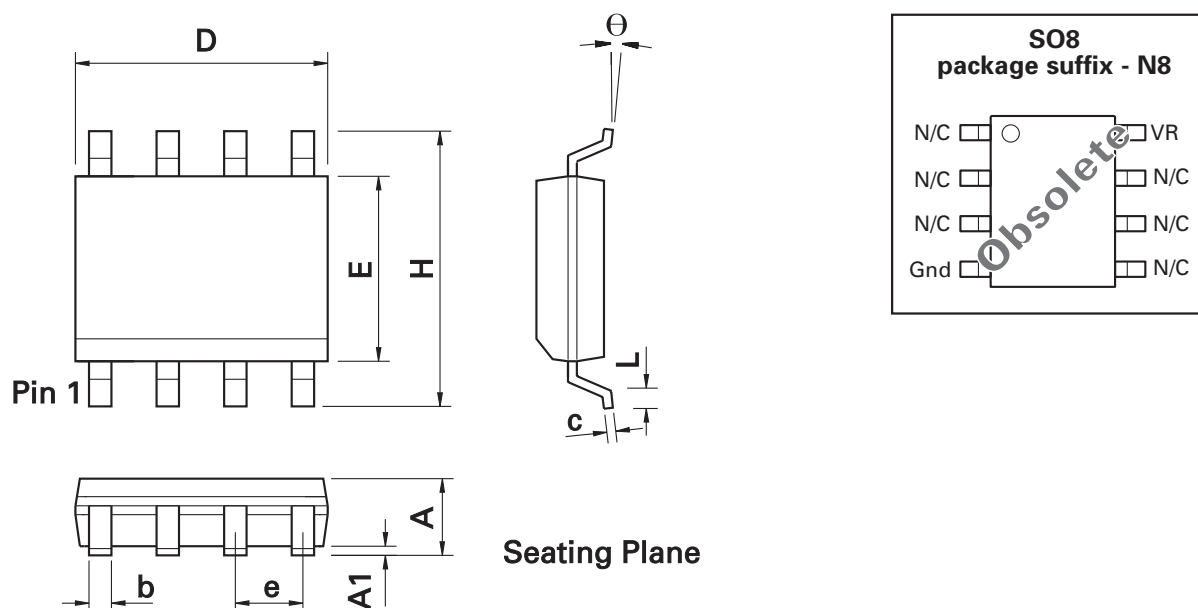

DIM	Inches		Millimeters		DIM	Inches		Millimeters	
	Min.	Max.	Min.	Max.		Min.	Max.	Min.	Max.
A	0.053	0.069	1.35	1.75	e	0.050 BSC		1.27 BSC	
A1	0.004	0.010	0.10	0.25	b	0.013	0.020	0.33	0.51
D	0.189	0.197	4.80	5.00	c	0.008	0.010	0.19	0.25
H	0.228	0.244	5.80	6.20	θ	0°	8°	0°	8°
E	0.150	0.157	3.80	4.00	h	0.010	0.020	0.25	0.50
L	0.016	0.050	0.40	1.27	-	-	-	-	-

Note: Controlling dimensions are in inches. Approximate dimensions are provided in millimeters

Europe	Americas	Asia Pacific	Corporate Headquarters
Zetex GmbH Streitfeldstraße 19 D-81673 München Germany	Zetex Inc 700 Veterans Memorial Highway Hauppauge, NY 11788 USA	Zetex (Asia Ltd) 3701-04 Metroplaza Tower 1 Hing Fong Road, Kwai Fong Hong Kong	Zetex Semiconductors plc Zetex Technology Park, Chadderton Oldham, OL9 9LL United Kingdom
Telefon: (49) 89 45 49 49 0 Fax: (49) 89 45 49 49 49 europe.sales@zetex.com	Telephone: (1) 631 360 2222 Fax: (1) 631 360 8222 usa.sales@zetex.com	Telephone: (852) 26100 611 Fax: (852) 24250 494 asia.sales@zetex.com	Telephone: (44) 161 622 4444 Fax: (44) 161 622 4446 hq@zetex.com

For international sales offices visit www.zetex.com/offices

Zetex products are distributed worldwide. For details, see www.zetex.com/salesnetwork

This publication is issued to provide outline information only which (unless agreed by the company in writing) may not be used, applied or reproduced for any purpose or form part of any order or contact or be regarded as a representation relating to the products or services concerned. The company reserves the right to alter without notice the specification, design, price or conditions of supply of any product or service.