

## Low-Power Programmable Quick Turn Clock™

### FEATURES

- Advanced low-power, space saving programmable PLL design
- Very low Jitter and Phase Noise (30-70ps Pk-Pk typical)
- Up to 2 programmable clock outputs
- Output frequency up to 75MHz.
- Accepts Crystal or Ref Clock input
  - Fundamental Crystal: 10MHz-50MHz
  - Reference Input: 1MHz to 100MHz
- Accepts  $\geq 0.1V$  reference signal input voltage
- Single 1.8V, 2.5V, or 3.3V  $\pm 10\%$  power supply
- Operating temperature range from -40C to 85°C
- Available in 6-pin TDFN, SC70, and SOT23, **GREEN** /RoHS compliant packages

### DESCRIPTION

The PL611s-08 is a low-power general purpose frequency synthesizer and a member of PhaseLink's Programmable 'Quick Turn Clock (QTC)' family. PhaseLink's PL611s-08 can generate two system clock frequencies of up to 75MHz from a 10MHz to 50MHz fundamental crystal or a 1MHz to 100MHz Reference clock source. The PL611s-08 offers the best phase noise and jitter performance, and power consumption of its rivals. Cascading of the ICs to produce additional clock frequencies is also supported.

### PACKAGE PIN CONFIGURATION

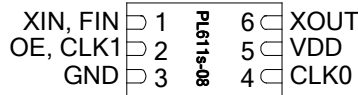

**DFN-6L**  
(2.0mmx1.3mmx0.6mm)

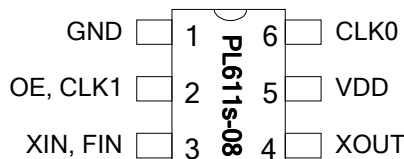

**SC70-6L**  
(2.3mmx2.25mmx1.0mm)

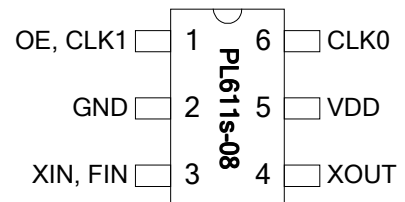

**SOT23-6L**  
(3.0mmx3.0mmx1.35mm)

### BLOCK DIAGRAM

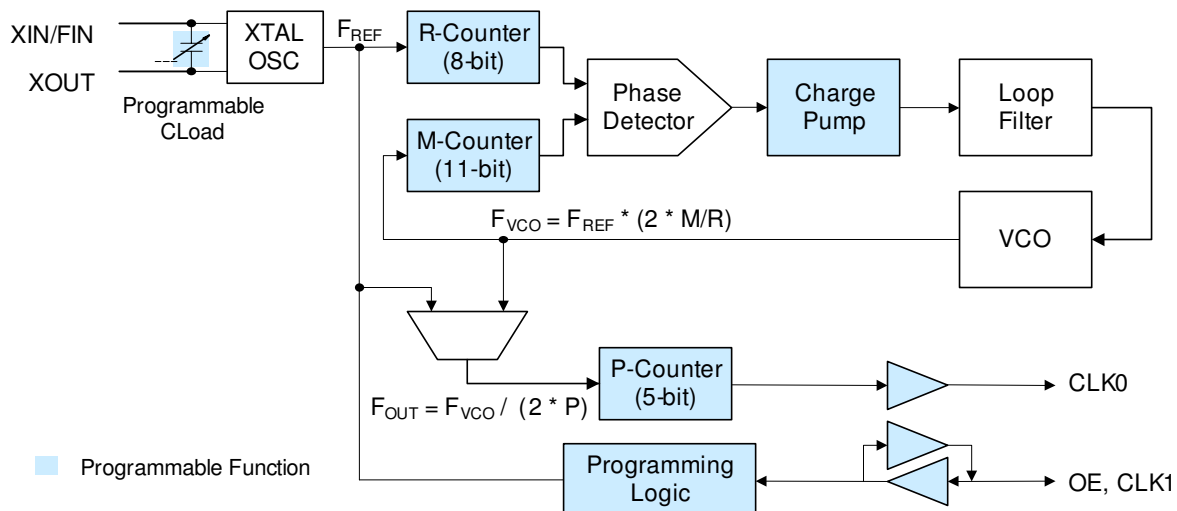

## Low-Power Programmable Quick Turn Clock™

### KEY PROGRAMMING PARAMETERS

CLK Output Frequency	Output Drive Strength	Programmable Input/Output
$F_{OUT} = F_{REF} * M / (R * P)$ Where M = 11 bit R = 8 bit P = 5 bit $CLK0 = F_{OUT}, F_{REF} \text{ or } F_{REF} / (2 * P)$ $CLK1 = F_{REF}, F_{REF}/2, CLK0 \text{ or } CLK0/2$	Three optional drive strengths to choose from: <ul style="list-style-type: none"> <li>• Low: 4mA</li> <li>• Std: 8mA (default)</li> <li>• High: 16mA</li> </ul>	One output pin can be configured as: <ul style="list-style-type: none"> <li>• OE - input</li> <li>• CLK1 – output</li> </ul>

### PACKAGE PIN ASSIGNMENT

Name	Pin Assignment			Type	Description
	SOT Pin #	SC70 Pin#	DFN Pin#		
OE, CLK1	1	4	2	B	This programmable I/O pin can be configured as an Output Enable (OE) input, or CLK1 output. This pin has an internal 60KΩ pull up resistor ( OE Function Only ).
GND	2	2, 5	3	P	GND connection
XIN, FIN	3	6	1	I	Crystal or Reference input pin
XOUT	4	-	6	O	Crystal Output pin
					Do Not Connect (DNC ) when FIN is present
VDD	5	1	5	P	VDD connection
CLK0	6	3	4	O	Programmable Clock Output

**Low-Power Programmable Quick Turn Clock™****FUNCTIONAL DESCRIPTION**

PL611s-08 is a highly featured, very flexible, advanced programmable PLL design for high performance, low-power, small form-factor applications. The PL611s-08 accepts a fundamental input crystal of 10MHz to 50MHz or reference clock input of 1MHz to 100MHz and is capable of producing two outputs up to 75MHz. This flexible design allows the PL611s-08 to deliver any PLL generated frequency,  $F_{REF}$  (Crystal or Ref Clk) frequency or  $F_{REF}/2$  to CLK0 and/or CLK1. Some of the design features of the PL611s-08 are mentioned below:

**PLL Programming**

The PLL in the PL611s-08 is fully programmable. The PLL is equipped with an 8-bit input frequency divider (R-Counter), and an 11-bit VCO frequency feedback loop divider (M-Counter). The output of the PLL is transferred to a 5-bit post VCO divider (P-Counter). The output frequency is determined by the following formula [ $F_{OUT} = F_{REF} * M / (R * P)$ ].

**Clock Output (CLK0)**

CLK0 is the main clock output. The PL611s-08 can also be programmed to provide a second clock output, CLK1, on the programmable I/O pin (see OE /CLK1 pin description below). The output of CLK0 can be configured as the PLL output ( $F_{VCO}/(2*P)$ ),  $F_{REF}$  (Crystal or Ref Clk Frequency) output, or  $F_{REF}/2$  output. The output drive level can be programmed to Low Drive (4mA), Standard Drive (8mA) or High Drive (16mA). The maximum output frequency is 75MHz.

**Programmable I/O (OE/CLK1)**

The PL611s-08 provides one programmable I/O pin which can be configured as one of the following functions:

**Output Enable (OE)**

The Output Enable feature allows the user to enable and disable the clock output(s) by toggling the OE pin. The OE pin incorporates a 60kΩ pull up resistor giving a default condition of logic "1".

**Clock Output (CLK1)**

The CLK1 feature allows the PL611s-08 to have an additional clock output. This output can be programmed to one of the following:

$F_{REF}$  - Reference ( Crystal or Ref Clk ) Frequency  
 $F_{REF} / 2$   
CLK0  
CLK0 / 2

## Low-Power Programmable Quick Turn Clock™

### ELECTRICAL SPECIFICATIONS

#### ABSOLUTE MAXIMUM RATINGS

PARAMETERS	SYMBOL	MIN.	MAX.	UNITS
Supply Voltage Range	V <sub>DD</sub>	-0.5	7	V
Input Voltage Range	V <sub>I</sub>	-0.5	V <sub>DD</sub> +0.5	V
Output Voltage Range	V <sub>O</sub>	-0.5	V <sub>DD</sub> +0.5	V
Soldering Temperature (Green package)			260	°C
Data Retention @ 85°C		10		Year
Storage Temperature	T <sub>S</sub>	-65	150	°C
Ambient Operating Temperature*		-40	85	°C

Exposure of the device under conditions beyond the limits specified by Maximum Ratings for extended periods may cause permanent damage to the device and affect product reliability. These conditions represent a stress rating only, and functional operations of the device at these or any other conditions above the operational limits noted in this specification is not implied. \*Operating temperature is guaranteed by design. Parts are tested to commercial grade only.

#### AC SPECIFICATIONS

PARAMETERS	CONDITIONS	MIN.	TYP.	MAX.	UNITS
Crystal Input Frequency (XIN)	Fundamental Crystal	10		50	MHz
Input (FIN) Frequency	Reference Clock	1		100	MHz
Input (FIN) Signal Amplitude	Internally AC coupled (High Frequency)	0.9		V <sub>DD</sub>	V <sub>pp</sub>
Input (FIN) Signal Amplitude	Internally AC coupled (Low Frequency) 3.3V ≤50MHz, 2.5V ≤40MHz, 1.8V ≤15MHz	0.1		V <sub>DD</sub>	V <sub>pp</sub>
Output Frequency	@ V <sub>DD</sub> =3.3V			75	MHz
	@ V <sub>DD</sub> =2.5V				MHz
	@ V <sub>DD</sub> =1.8V				MHz
Settling Time	At power-up (after V <sub>DD</sub> increases over 1.62V)			2	ms
Output Enable Time	OE Function; Ta=25° C, 15pF Load			10	ns
	PDB Function; Ta=25° C, 15pF Load			2	ms
VDD Sensitivity	Frequency vs. V <sub>DD</sub> +/-10%	-2		2	ppm
Output Rise Time	15pF Load, 10/90% V <sub>DD</sub> , High Drive, 3.3V		1.2	1.7	ns
Output Fall Time	15pF Load, 90/10% V <sub>DD</sub> , High Drive, 3.3V		1.2	1.7	ns
Duty Cycle	PLL Enabled, @ V <sub>DD</sub> /2	45	50	55	%
Period Jitter, Pk-to-Pk* (measured from 10,000 samples)	With capacitive decoupling between V <sub>DD</sub> and GND.		70		ps

\* Note: Jitter performance depends on the programming parameters.

## Low-Power Programmable Quick Turn Clock™

### DC SPECIFICATIONS

PARAMETERS	SYMBOL	CONDITIONS	MIN.	TYP.	MAX.	UNITS
Supply Current, Dynamic, with Loaded CMOS Outputs	$I_{DD}$	@ $V_{DD} = 3.3V$ , 27MHz, load=15pF		5.5		mA
Supply Current, Dynamic, with Loaded CMOS Outputs	$I_{DD}$	@ $V_{DD} = 2.5V$ , 27MHz, load=15pF		3.5		mA
Supply Current, Dynamic with Loaded CMOS Outputs	$I_{DD}$	@ $V_{DD} = 1.8V$ , 27MHz, load=5pF		1.8*		mA
Supply Current, Dynamic, with Loaded Outputs	$I_{DD}$	When PDB=0			<5	$\mu A$
Operating Voltage	$V_{DD}$		1.62		3.63	V
Output Low Voltage	$V_{OL}$	$I_{OL} = +4mA$ Standard Drive			0.4	V
Output High Voltage	$V_{OH}$	$I_{OH} = -4mA$ Standard Drive	$V_{DD} - 0.4$			V
Output Current, Low Drive	$I_{OSD}$	$V_{OL} = 0.4V$ , $V_{OH} = 2.4V$	4			mA
Output Current, Standard Drive	$I_{OSD}$	$V_{OL} = 0.4V$ , $V_{OH} = 2.4V$	8			mA
Output Current, High Drive	$I_{OHD}$	$V_{OL} = 0.4V$ , $V_{OH} = 2.4V$	16			mA
Short-Circuit Current	$I_S$			$\pm 50$		mA

\* Note: Please contact PhaseLink, if super-low-power is required.

### CRYSTAL SPECIFICATIONS

PARAMETERS	SYMBOL	MIN.	TYP.	MAX.	UNITS
Fundamental Crystal Resonator Frequency	$F_{XIN}$	10		50	MHz
Crystal Loading Rating (The IC can be programmed for any value in this range.)	$C_L (xtal)$	8		12	pF
Maximum Sustainable Drive Level				100	$\mu W$
Operating Drive Level			30		$\mu W$
Metal Can Crystal	Shunt Capacitance	$C_0$		5.5	pF
	ESR Max	ESR		50	$\Omega$
Small SMD Crystal	Shunt Capacitance	$C_0$		2.5	pF
	ESR Max	ESR		80	$\Omega$

**Low-Power Programmable Quick Turn Clock™**

**LAYOUT RECOMMENDATIONS**

The following guidelines are to assist you with a performance optimized PCB design:

- Keep all the PCB traces to the PL611s-08 as short as possible, as well as keeping all other traces as far away from it as possible.
- Place a 0.01μF~0.1μF decoupling capacitor between VDD and GND, on the component side of the PCB, close to the VDD pin. It is not recommended to place this component on the backside of the PCB. Going through vias will reduce the signal integrity, causing additional jitter and phase noise.
- It is highly recommended to keep the VDD and GND traces as short as possible.
- When connecting long traces (> 1 inch) to a CMOS output, it is important to design the traces as a transmission line or 'stripline', to avoid reflections or ringing. In this case, the CMOS output needs to be matched to the trace impedance. Usually 'striplines' are designed for 50Ω impedance and CMOS outputs usually have lower than 50 Ω impedance so matching can be achieved by adding a resistor in series with the CMOS output pin to the 'stripline' trace.
- Please contact PhaseLink for additional information on how to design outputs driving long traces or for additional application assistance.

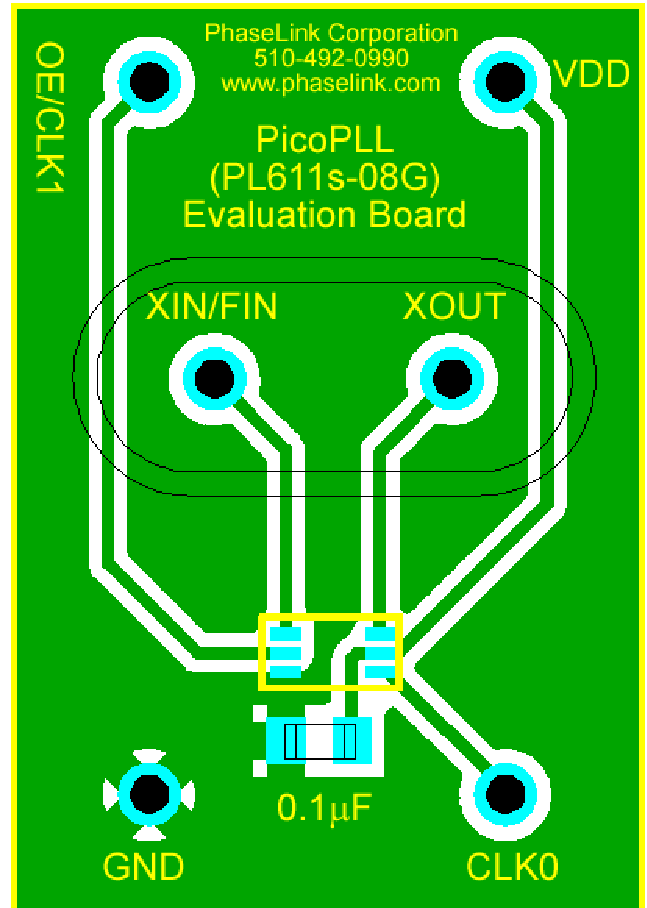

DFN-6L Evaluation Board

**Low-Power Programmable Quick Turn Clock™**

**PACKAGE DRAWINGS (GREEN PACKAGE COMPLIANT)**

**SOT23-6L**

Symbol	Dimension in MM	
	Min.	Max.
A	1.05	1.35
A1	0.05	0.15
A2	1.00	1.20
b	0.30	0.50
c	0.08	0.20
D	2.80	3.00
E	1.50	1.70
H	2.60	3.0
L	0.35	0.55
e	0.95 BSC	

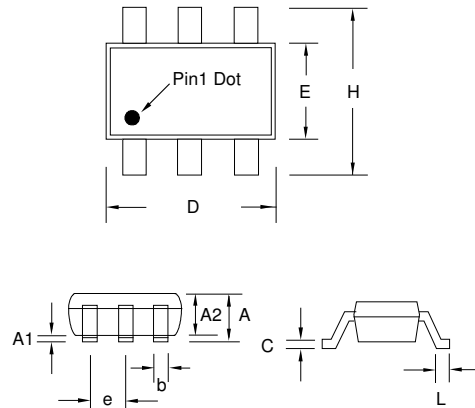

**SC70-6L**

Symbol	Dimension in MM	
	Min.	Max.
A	0.80	1.00
A1	0.00	0.09
A2	0.80	0.91
b	0.15	0.30
c	0.08	0.25
D	1.85	2.25
E	1.15	1.35
H	2.00	2.30
L	0.21	0.41
e	0.65BSC	

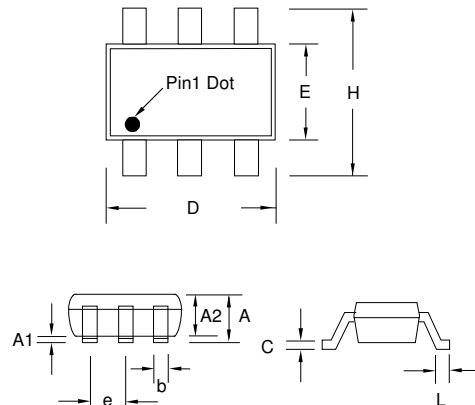

**DFN-6L**

Symbol	Dimension in MM	
	Min.	Max.
A	0.50	0.60
A1	0.00	0.05
A3	0.152	0.152
b	0.15	0.25
e	0.40BSC	
D	1.25	1.35
E	1.95	2.05
D1	0.75	0.85
E1	0.95	1.05
L	0.20	0.30

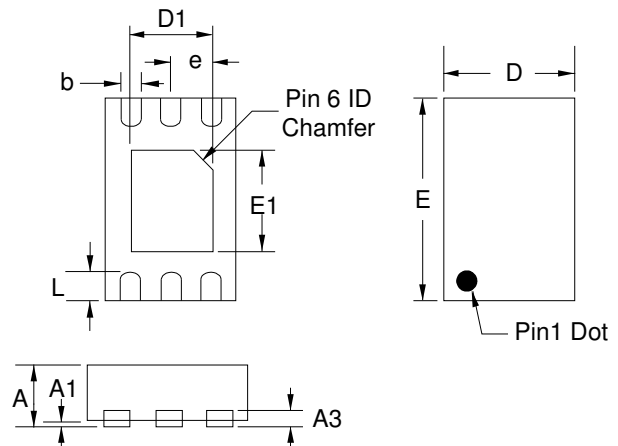

**Low-Power Programmable Quick Turn Clock™**

**ORDERING INFORMATION (GREEN PACKAGE COMPLIANT)**

*For part ordering, please contact our Sales Department:*  
47745 Fremont Blvd., Fremont, CA 94538, USA  
Tel: (510) 492-0990 Fax: (510) 492-0991

**PART NUMBER**

The order number for this device is a combination of the following:  
Part number, Package type and Operating temperature range

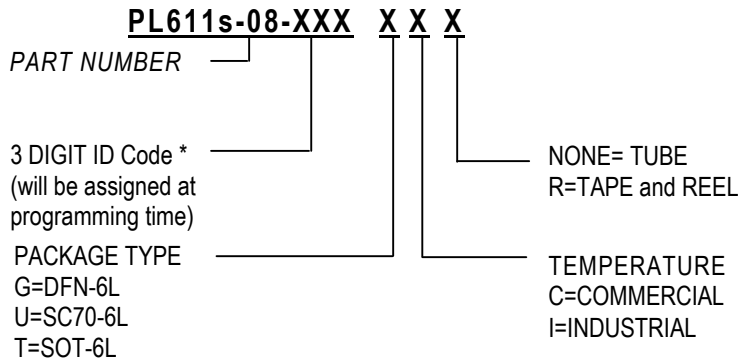

Part Number/Order Number	Marking†	Package Option
PL611s-08-XXXGC-R	XXX	6-Pin DFN (Tape and Reel)
PL611s-08-XXXUC-R	XXX	6-Pin SC70 (Tape and Reel)
PL611s-08-XXXTC-R	08XXX	6-Pin SOT23 (Tape and Reel)

† Note: 'XXX' designates marking identifier that could be independent of the part number.

PhaseLink Corporation, reserves the right to make changes in its products or specifications, or both at any time without notice. The information furnished by Phaselink is believed to be accurate and reliable. However, PhaseLink makes no guarantee or warranty concerning the accuracy of said information and shall not be responsible for any loss or damage of whatever nature resulting from the use of, or reliance upon this product.

**LIFE SUPPORT POLICY:** PhaseLink's products are not authorized for use as critical components in life support devices or systems without the express written approval of the President of PhaseLink Corporation.

Solder reflow profile available at [www.phaselink.com/QA/solderingGreen.pdf](http://www.phaselink.com/QA/solderingGreen.pdf)