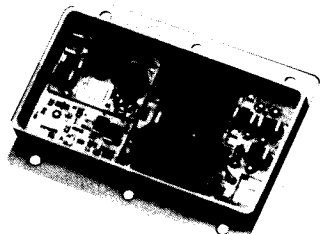


## 60 WATT, TRIPLE OUTPUT DC - DC CONVERTERS



### FEATURES

- **-55°C To +125°C Electrical Characteristic Operation.**
- **Military Processing Available**
- **±15V and +5V or ±12V and +5V Output Operation from 16 to 40Vdc Input Range**
- **Internal Input Filter**
- **Meets Shock and Vibration per MIL-STD-883 Method 2007**
- **2,650,000 Hrs MTBF**
- **19.4 Watts Per Cubic Inch Power Density**

### DESCRIPTION

The PWR-82400 Series are full mil temperature range 60 watt dc-dc converters. The output is characterized from -55°C to +125°C. Processing includes element evaluation and full environmental screening, thus eliminating the need for complex specification control drawings. Military processing is available.

The PWR-82400/402 are 60 watt triple output, 225 kHz dc-dc converters. The PWR-82400 operates over a wide input range of 16V to 40Vdc and supplies ±15V at 1.33A each and +5V at 4A while the PWR-82402 supplies ±12V at 1.7A each and +5V at 4A. High input-to-output isolation along with separate output returns enables the user to power

both sensitive analog circuitry while maintaining isolation from digital signals. The PWR-82400 Series are short circuit protected by using internal pulse by pulse current limit circuitry which monitors the output load. Excellent line and load regulation are achieved by monitoring the +5V output thru o<sub>1</sub> coupling. In addition, the output ripple is typically 50mVp-p thru the use of internal output filters.

The PWR-82400 Series dc-dc converters make an excellent choice for distributed power applications with their small size, high power density, and military processing availability.

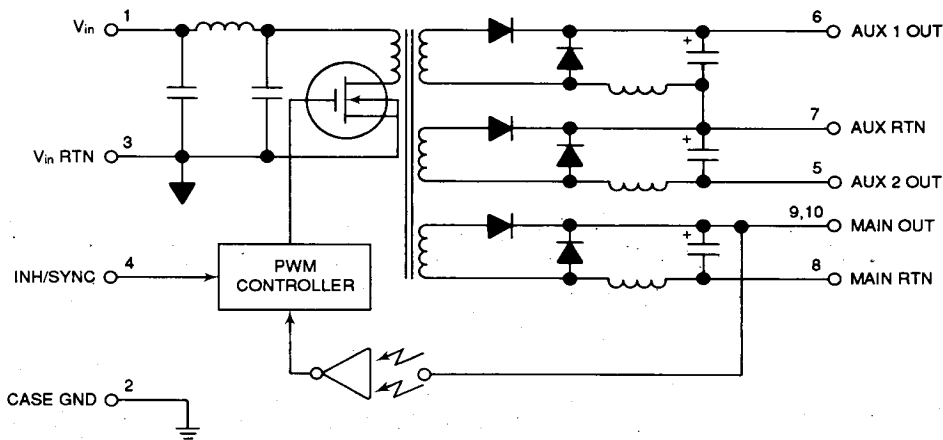


FIGURE 1. PWR-82400 SERIES BLOCK DIAGRAM

**TABLE 1. ABSOLUTE MAXIMUM RATINGS**

Input Voltage	16V to 50Vdc
Power Output	Internally limited, 60W
Short Circuit Duration	Indefinite
Temperature Range (See note 1.)	Operating: -55°C to +125°C case Storage: -65°C to +150°C
Soldering	250°C for 10 seconds

**TABLE 2. SPECIFICATIONS**

T<sub>C</sub> = -55°C to +125°C, Input voltage range = 16Vdc to 40Vdc unless otherwise specified.

PARAMETER	CONDITIONS	PWR-82400			PWR-82402			UNITS
		MIN.	TYP.	MAX.	MIN.	TYP.	MAX.	
<b>OUTPUT</b>								
Voltage								
Main	V <sub>in</sub> =28Vdc, T <sub>C</sub> =25°C	4.90	4.95	5.05	4.90	5.00	5.05	Vdc
Aux1	Full Load	15.05	15.30	15.55	11.65	12.00	12.55	Vdc
Aux2		-15.55	-15.30	-15.05	-12.55	-12.00	-11.65	Vdc
Tempco								
Main			50			50		ppm/°C
Aux1			150			150		ppm/°C
Aux2			150			150		ppm/°C
Current								
Main	See note 2.			4.0			4.0	Adc
Aux1				1.33			1.7	Adc
Aux2				-1.33			-1.7	Adc
Ripple								
Main	Full Load		50	85		50	85	mVp-p
Aux1	DC to 1MHz		50	85		50	85	mVp-p
Aux2	V <sub>in</sub> =28Vdc		50	85		50	85	mVp-p
Power	See notes 1 & 2.			60			60	W
<b>REGULATION</b>								
Line								
Main	V <sub>in</sub> =19 to 40Vdc		0.05	0.1		0.05	0.1	%
Aux1	Full Load		1.0	1.3		1.0	1.3	%
Aux2			1.0	1.3		1.0	1.3	%
Load								
Main	1% of Full Load to Full Load		0.5	1.0		0.5	1.0	%
Aux1	V <sub>in</sub> =28Vdc		2.0	3.0		2.0	3.0	%
Aux2			2.0	3.0		2.0	3.0	%
<b>INPUT</b>								
Current	No Load		50	80		50	80	mAdc
	Inhibited		25	35		25	35	mAdc
<b>EFFICIENCY</b>	Full Load, T <sub>C</sub> =25°C	80	83		80	83		%
	See figure 3. V <sub>in</sub> =28Vdc							
<b>I/O ISOLATION</b>	500Vdc	100			100			M Ohm
<b>INHIBIT/SYNC</b>								
Po sync	Required for sync operation.	4.5			4.5			W
Logic Low				0.8			0.8	Vdc
Logic High		2.0			2.0			Vdc
I <sub>l</sub> inhibit			0.5	1.0		0.5	1.0	mAdc
I <sub>h</sub> inhibit			2.0	2.75		2.0	2.75	mAdc
I <sub>i</sub> sync		40			40			mA ac peak
Start-up Time:								
From Inhibit			5	10		5	10	mS
From V <sub>in</sub>			30	40		30	40	mS
Sync freq	V <sub>in</sub> = 28Vdc	260		370	260		370	kHz
Sync duty cycle	V <sub>in</sub> = 28Vdc	50		90	50		90	%
<b>SWITCHING FREQ</b>			225			225		kHz
<b>WEIGHT</b>				160			160	g

**NOTES:** 1. Above 100°C, derate linearly to 10W at 125°C. (See figure 2.)  
 2. Below V<sub>in</sub>=18Vdc, derate linearly to 30W at V<sub>in</sub>=16Vdc.



**INPUT**

The PWR-82400 Series accepts an input voltage range of 16V to 40Vdc and uses an internal input Pi filter to limit the input reflected current ripple noise. Full power operation is capable down to 18Vdc. For operation during MIL-STD-704D emergency conditions refer to Figure 4.

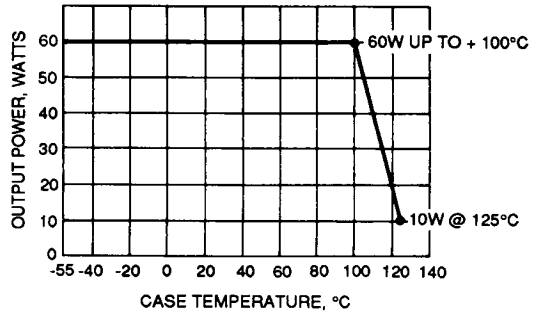
**INHIBIT/SYNC**

The PWR-82400 Series allows for both inhibit or synchronization by applying a TTL signal to Pin 4. For the inhibit feature, Pin 4 is held low thereby disabling the internal PWM and halting operation of the converter. This allows for remote turn on and turn off of the converter with very low quiescent current during the off cycle.

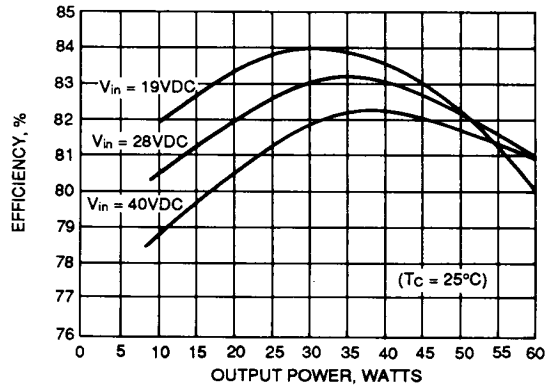
Synchronization is achieved by applying a TTL signal to Pin 4 with a duty cycle from 50 to 90 percent. The external synchronization frequency range is 260 kHz to 370 kHz. This feature allows the user to synchronize the converter with a system clock thus eliminating false triggering from digital and system generated noise. For proper sync operation, the sync pulse input current should be 40mA min., and a minimum load of 4.5W maintained at the output of the converter.

**THERMAL MANAGEMENT**

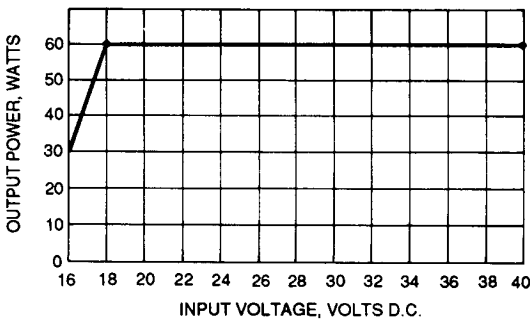
The PWR-82400 Series converters operate from -55°C to +125°C case temperature. Full power output is from -55°C to +100°C case with derating to +125°C case as shown in Figure 2. The use of forced air and/or additional heat sinking may be required in high temperature applications.



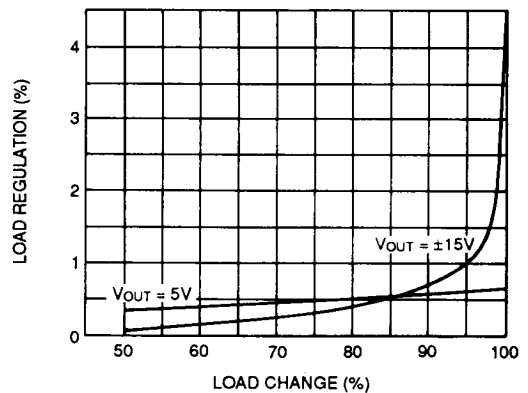
**FIGURE 2. OUTPUT POWER VS. CASE TEMPERATURE**



**FIGURE 3. TYPICAL EFFICIENCY VS. OUTPUT POWER**

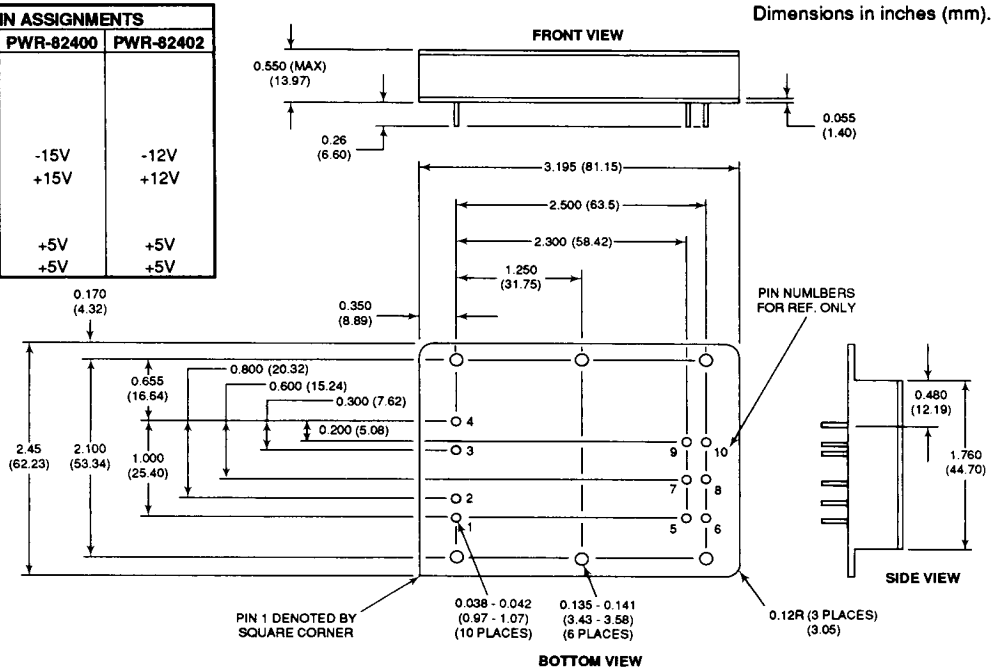


**FIGURE 4. OUTPUT POWER VS. INPUT VOLTAGE**



**FIGURE 5. LOAD REGULATION VS. %LOAD CHANGE TO FULL LOAD**

TABLE 3. PIN ASSIGNMENTS			
PIN #	FUNCTION	PWR-82400	PWR-82402
1	V <sub>in</sub>		
2	CASE GND		
3	V <sub>in</sub> RTN		
4	INH/SYNC		
5	AUX 2 OUT	-15V	-12V
6	AUX 1 OUT	+15V	+12V
7	AUX RTN		
8	MAIN RTN		
9	MAIN OUT	+5V	+5V
10	MAIN OUT	+5V	+5V



**FIGURE 6. MECHANICAL OUTLINE**

## PROCESSING AND ENVIRONMENTAL SCREENING

All of DDC's PWR-82400 Series DC-DC converters are packaged in a fully hermetic metal case with a parallel seam welded cover and undergo the following standard environmental screening:

- Element evaluation: Per Method 5008 of MIL-STD-883
- Pre-Cap internal visual inspection: Per Method 2017
- Stabilization Bake: 24 hours at 150°C
- Temperature Cycle: 10 times per Method 1010, Cond. B
- Constant Acceleration: 500g per Method 2001
- Gross Leak: Per Method 1014, Cond. C
- Fine Leak: Per Method 1014, Cond. A
- Burn-In: 168 hours at T<sub>c</sub> = +100°C (Not performed on -300, -100 units)
- Final Electrical Test: Room, Hot, Cold (Testing at +25°C only for -300 units)
- Final External Visual Inspection: Per Method 2009

Vibration testing in all 3 axes, per MIL-STD-883, Method 2007 Cond. A, can also be performed.

D

## ORDERING INFORMATION

(See Processing and Environmental Screening.)

PWR-8240X-110

- Reliability Grade:
  - 0 = Standard DDC Processing
  - 1 = Military processing available
  - 2 = Military processing available but without QCI testing
- Temperature Range:
  - 1 = -55°C to +125°C
  - 3 = 0°C to +70°C
- Auxiliary Outputs:
  - 0 = ±15 Vdc
  - 2 = ±12 Vdc

