

W65C832 CPU Datasheet v2.0

Date: 9-6-10

Updated and .PDFed by ReactiveMicro.com to resolve several issues with the original datasheet.

Thanks to Tom and Constantine for sharing and helping the Community!
Without them this datasheet and all related projects that come from it would not be possible. Thanks guys!

Original location and files: http://apple2.org.za/gswv/a2zine/Docs/CPU_65832

The 65C832 CPU Manual in GIF Graphic format
Copyright © 1999 by Constantine Garland

This folder contains a series of 8 bit 256 color GIF graphic files that are the copyrighted material of Constantine Garland.

TOC1.GIF through TOC5.GIF consist of the manual information, specification and data sheet signed by Woz and the table of contents. M1.GIF through M51.GIF contains the entire context of the 65C832 CPU Preliminary Manual, information, specification and diagrams and data sheets.

They may be used without any restrictions for historical information, educational, research and graphic art needs by anybody, provided no fees or money are charged for such use.

Apple IIgs Forever!
Constantine

Subject: Re: 65832 CPU??? Apple //f???
Date: 11 Apr 2002 04:56:36 GMT
From: cturley2@aol.com (Cturley2)
Newsgroups: comp.sys.apple2

Rubywand wrote asking:

<< That's a pretty rare manual. How did you obtain it?>>

;-) Legally -- by snail mail from a guy in Oklahoma that offered to send it to me for free. He told me he was a student in high school years ago and decided he wanted info on the then rumored NEW 65832 CPU for the IIGs.

He contacted WDC with his request convinced them he was a big time chip manufacture interested in buying it for commercial production and they sent him one.

I got wind of him from an offer he posted to this NG back in 1995 -- asking if anybody was interested in it for free. I emailed him first on it and he mailed it on to me promptly.

I showed it to Woz at a rock concert back in 1996 -- he was astounded when reviewing it and signed the cover page for me. That's why it has that Woz sig. on it. As such -- yes, it is pretty rare -- and -- with mine and the autograph from Woz on it's cover page --- it's a priceless and VERY rare one-of-a-kind.

WDC told me on several occasions in our many telcons: "We have no such manual our self now -- only made a dozen or so and mailed all of them out to clients many years ago." I've never found anybody else that has one either.

Mine may well be the only one left in existence now (???). That's why I digitized it *cover to cover* and put it online to share the info with the world.

Cheers,
Tom

W65C832

INFORMATION, SPECIFICATION AND DATA SHEET

PRELIMINARY

A
B
O
R
V
V
R
V
M
P
M
R
R
R
R
V
V
E
V
M
P
L
Q
T
D
P
S
S
D
/
X
I
B
-
-
-
Y
-
S
-
A
X
2
E

	6	5	4	3	2	1	44	43	42	41	40	
NMI-	7										39	E8/E16
VPA	8										38	R/W-
VDD	9										37	VDD
A0	10										36	D0/A16
A1	11										35	D1/A17
VSS	12						W65C832				34	D2/A18
A2	13										33	D3/A19
A3	14										32	D4/A20
A4	15										31	D5/A21
A5	16										30	D6/A22
A6	17										29	D7/A23
	18	19	20	21	22	23	24	25	26	27	28	
	A	A	A	A	A	V	V	A	A	A	A	
	7	8	9	1	1	S	S	1	1	1	1	
				0	1	S	S	2	3	4	5	

Woz

TABLE OF CONTENTS

<hr/>	
INTRODUCTION	1
<hr/>	
SECTION 1: W65C832 FUNCTION DESCRIPTION	2
1.1 Instruction Register and Decode	2
1.2 Timing Control Unit	2
1.3 Arithmetic and Logic Unit	2
1.4 Internal Registers.	2
1.5 Accumulators.	3
1.6 Data Bank Register.	3
1.7 Direct.	3
1.8 Index	3
1.9 Processor Status.	3
1.10 Program Bank Register	4
1.11 Program Counter	4
1.12 Stack Pointer	4
<hr/>	
SECTION 2: PIN FUNCTION DESCRIPTION	10
2.1 Abort11
2.2 Address Bus11
2.3 Bus Enable.11
2.4 Data/Address Bus.11
2.5 Emulation Status.12
2.6 Interrupt Request12
2.7 Memory Lock12
2.8 Memory/Index Select Status.12
2.9 Non-Maskable Interrupt.12
2.10 Phase 2 In.12
2.11 Read/Write.13
2.12 Ready13
2.13 Reset13
2.14 Valid Data Address, Valid Program Address14
2.15 VDD and VSS14
2.16 Vector Pull14
<hr/>	
SECTION 3: ADDRESSING MODES	15
3.1 Reset and Interrupt Vectors15
3.2 Stack15
3.3 Direct.15
3.4 Program Address Space15
3.5 Data Address Space.15

SECTION 4: TIMING, AC AND DC CHARACTERISTICS	24
4.1 Absolute Maximum Ratings24
4.2 DC Characteristics25
4.3 AC Characteristics, 5V.26
4.4 AC Characteristics, 1.2V.27
SECTION 5: ORDERING INFORMATION	29
SECTION 6: APPLICATION INFORMATION	30
SECTION 7: ASSEMBLER SYNTAX STANDARDS	43
7.1 Directives43
7.2 Comments43
7.3 The Source Line43
SECTION 8: CAVEATS	46
8.1 Stack Addressing47
8.2 Direct Addressing47
8.3 Absolute Indexed Addressing48
8.4 ABCRT48
8.5 VDA and VPA48
8.6 Apple II, IIc, IIc and II+ Disk Systems48
8.7 DB/BA Operation49
8.8 M/X Output49
8.9 All Opcodes Function in All Modes of Operation.49
8.10 Indirect Jumps49
8.11 Switching Modes49
8.12 Hardware Interrupts, BRK, and COP Instructions.50
8.13 Binary Mode50
8.14 WAI Instruction50
8.15 STP Instruction50
8.16 COP Signatures.50
8.17 WDM Opcode Use.50
8.18 RDY Pulled During Write51
8.19 MVN and MVP51
8.20 Interrupt Priorities.51
8.21 Transfers from differing sized registers.51
8.22 Stack Transfers51
8.23 REP/SEP51

TABLE OF CONTENTS

FIGURES

SECTION 1: FUNCTION DESCRIPTION	2
1-1 Internal Architecture Block Diagram	5
1-2 W65C832 Native Mode Programming Model	6
1-3 W65C816 16-bit Emulation Programming Model.	7
1-4 W65C02 8-bit Emulation Programming Model.	8
1-5 W65C832 Status Register Coding.	9

SECTION 2: PIN FUNCTION DESCRIPTION	10
2-1 W65C832 44 PLCC Pinout.	10

SECTION 4: TIMING, AC AND DC CHARACTERISTICS	24
4-1 Timing Diagram.	28

TABLE OF CONTENTS

TABLES

<hr/>	
SECTION 1: FUNCTION DESCRIPTION	2
1-1 W65C832 Emulation and Register Width Control.	9
<hr/>	
SECTION 2: PIN FUNCTION DESCRIPTION	10
2-1 Pin Function Table.	11
<hr/>	
SECTION 3: ADDRESSING MODES	15
3-1 Address Mode Formats.	22
3-2 Addressing Mode Summary	23
<hr/>	
SECTION 4: TIMING, AC AND DC CHARACTERISTICS	24
4-1 Absolute Maximum Ratings.	24
4-2 DC Characteristics.	25
4-3A AC Characteristics-5V, 4-7MHz	26
4-3B AC Characteristics-5V, 8-10MHz.	26
4-4A AC Characteristics-1.2V, 40 KHz	27
<hr/>	
SECTION 6: APPLICATION INFORMATION	30
6-1 Instruction Set	30
6-2 Vector Locations.	31
6-3 Opcode Matrix	32
6-4 Operation, Operation Codes and Status Register.	33
6-5 Instruction Operation	34-42
<hr/>	
SECTION 7: ASSEMBLER SYNTAX STANDARDS	43
7-3-1 Alternate Mnemonics	44
7-3-2 Byte Selection Operator	45
<hr/>	
SECTION 8: CAVEATS	46
8-1 Compatibility Issues.	46-47

INTRODUCTION

The WDC W65C832 is a CMOS 32-bit microprocessor featuring total software compatibility with their 8-bit NMOS and 8-bit and 16-bit CMOS 6500-series predecessors. The W65C832 is pin-to-pin compatible with 16-bit devices currently available. These devices offer the many advantages of CMOS technology, including increased noise immunity, higher reliability, and greatly reduced power requirements. A software switch determines whether the processor is in the 8-bit or 16-bit "emulation" mode, or in the native mode, thus allowing existing systems to use the expanded features.

As shown in the processor programming model, the Accumulator, ALU, X and Y Index registers have been extended to 32 bits. A 16-bit Program Counter, Stack Pointer and Direct Page register augments the Direct Page addressing mode (formerly Zero Page addressing). Separate Program Bank and Data Bank registers allow 24-bit memory addressing with segmented or linear addressing for program space and 32-bit 4GByte data space for ASIC use although only 24 bits of address are available in the standard pin-out.

Four signals provide the system designer with many options. The ABORT input can interrupt the currently executing instruction without modifying internal register, thus allowing virtual memory system design. Valid Data Address (VDA) and Valid Program Address (VPA) outputs facilitate dual cache memory by indicating whether a data segment or program segment is accessed. Modifying a vector is made easy by monitoring the Vector Pull (VP) output.

KEY FEATURES OF THE W65C832

- * Advanced CMOS design for low power power consumption and increased noise immunity
- * Single 1.2-5.25V power supply, as specified
- * Emulation mode allows complete hardware and software compatibility with W65C816 designs
- * 24-bit address bus allows access to 16 MBytes of memory space
- * Full 32-bit ALU, Accumulator, and Index Registers
- * Valid Data Address (VDA) and Valid Program Address (VPA) output allows dual cache and cycle steal DMA implementation
- * Vector Pull (VP) output indicates when interrupt vectors are being addressed. May be used to implement vectored interrupt design
- * Abort (ABORT) input and associated vector supports virtual memory system design
- * Separate program and data bank registers allow program segmentation or full 16-MByte linear addressing
- * New Direct Register and stack relative addressing provides capability for re-entrant, re-cursive and re-locatable programming
- * 24 addressing modes-13 original 6502 modes, plus 11 new addressing modes with 91 instructions using 255 opcodes
- * Wait-for-Interrupt (WAI) and Stop-the Clock (STP) instructions further reduce power consumption, decrease interrupt latency and allows synchronization with external events
- * Co-Processor (COP) instruction with associated vector supports co-processor configurations, i.e., floating point processors
- * Block move ability

SECTION 1

W65C832 FUNCTION DESCRIPTION

The W65C832 provides the design engineer with upward mobility and software compatibility in applications where a 32-bit system configuration is desired. The W65C832's 32-bit hardware configuration, coupled with current software allows a wide selection of system applications. In the Emulation mode, the W65C832 offers many advantages, including full software compatibility with 6502, W65C02 or W65C816 coding. In addition, the W65C832's powerful instruction set and addressing modes make it an excellent choice for new 32-bit designs.

Internal organization of the W65C832 can be divided into two parts: 1) The Register Section and 2) The Control Section. Instructions (or opcodes) obtained from program memory are executed by implementing a series of data transfers within the Register Section. Signals that cause data transfers to be executed are generated within the Control Section. The W65C832 has a 32-bit internal architecture with an 8-bit external data bus.

1.1 Instruction Register and Decode

An opcode enters the processor on the Data Bus, and is latched into the Instruction Register during the instruction fetch cycle. This instruction is then decoded, along with timing and interrupt signals, to generate the various Instruction Register control signals.

1.2 Timing Control Unit (TCU)

The Timing Control Unit keeps track of each instruction cycle as it is executed. The TCU is set to zero each time an instruction fetch is executed, and is advanced at the beginning of each cycle for as many cycles as is required to complete the instruction. Each data transfer between registers depends upon decoding the contents of both the Instruction Register and the Timing Control Unit.

1.3 Arithmetic and Logic Unit (ALU)

All arithmetic and logic operations take place within the 32-bit ALU. In addition to data operations, the ALU also calculates the effective address for relative and indexed addressing modes. The result of a data operation is stored in either memory or an internal register. Carry, Negative, Overflow and Zero flags may be updated following the ALU data operation.

1.4 Internal Registers (Refer to Programming Model)

1.5 Accumulator

The Accumulator is a general purpose register which stores one of the operands, or the result of most arithmetic and logical operations. In the Native mode the Accumulator can be 8-, 16- or 32-bits wide.

1.6 Data Bank Register (DBR)

During modes of operation, the 8-bit Data Bank Register holds the default bank address for memory transfers. The 24-bit address is composed of the 16-bit instruction effective address and the 8-bit Data Bank address. The register value is multiplexed with the data value and is present on the Data/Address lines during the first half of a data transfer memory cycle for the W65C832. The Data Bank Register is initialized to zero during Reset.

1.7 Direct (D)

The 16-bit Direct Register provides an address offset for all instructions using direct addressing. The effective bank zero address is formed by adding the 8-bit instruction operand address to the Direct Register. The Direct Register is initialized to zero during Reset.

1.8 Index (X and Y)

There are two Index Registers (X and Y) which may be used as general purpose registers or to provide an index value for calculation of the effective address. When executing an instruction with indexed addressing, the microprocessor fetches the opcode and the base address, and then modifies the address by adding the Index Register contents to the address prior to performing the desired operation. Pre-indexing or post-indexing of indirect addresses may be selected. In the Native mode, both Index Registers are 32 bits wide (providing the Index Select Bit (X) equals zero). If the Index Select Bit (X) equals one, both registers will be 8 bits wide, and the high bytes if forced to zero.

1.9 Processor Status (P)

The 8-bit Processor Status Register contains status flags and mode select bits. The Carry (C), Negative (N), Overflow (V), and Zero (Z) status flags serve to report the status of most ALU operations. These status flags are tested by use of Conditional Branch instructions. The Decimal (D), IRQ Disable (I), Memory/Accumulator (M), and Index (X) bits are used as mode select flags. These flags are set by the program to change microprocessor operations.

The Emulation (E8 and E16) select and the Break (B) flags are accessible only through the Processor Status Register. The Emulation (E8) mode select flag is selected by the Exchange Carry and Emulation Bits (XCE) instruction. The XFE instruction exchanges the Emulation (E8 and E16) mode select flags with the Overflow and Carry Flags. Table 1, Emulation and Register Width Control, illustrates the features of the Native and Emulation modes. The M and X flags are always equal to one in the 8-bit Emulation mode. When an interrupt occurs during the Emulation mode, the Break flag is written to stack memory as bit 4 of the Processor Status Register.

1.10 Program Bank Register (PBR)

The 8-bit Program Bank Register holds the bank address for all instruction fetches. The 24-bit address consists of the 16-bit instruction effective address and the 8-bit Program Bank address. The register value is multiplexed with the data value and presented on the Data/Address lines during the first half of a program memory read cycle. The Program Bank Register is initialized to zero during Reset. The PHK instruction pushes the PBR register onto the Stack.

1.11 Program Counter (PC)

The 16-bit Program Counter Register provides the addresses which are used to step the microprocessor through sequential program instructions. The register is incremented each time an instruction or operand is fetched from program memory.

1.12 Stack Pointer (S)

The Stack Pointer is a 16-bit register which is used to indicate the next available location in the stack memory area. It serves as the effective address in stack addressing modes as well as subroutine and interrupt processing. The Stack Pointer allows simple implementation of nested subroutines and multiple-level interrupts. During the Emulation mode, the Stack Pointer high-order byte (SH) is always equal to one. The bank address for all stack operations is Bank zero.

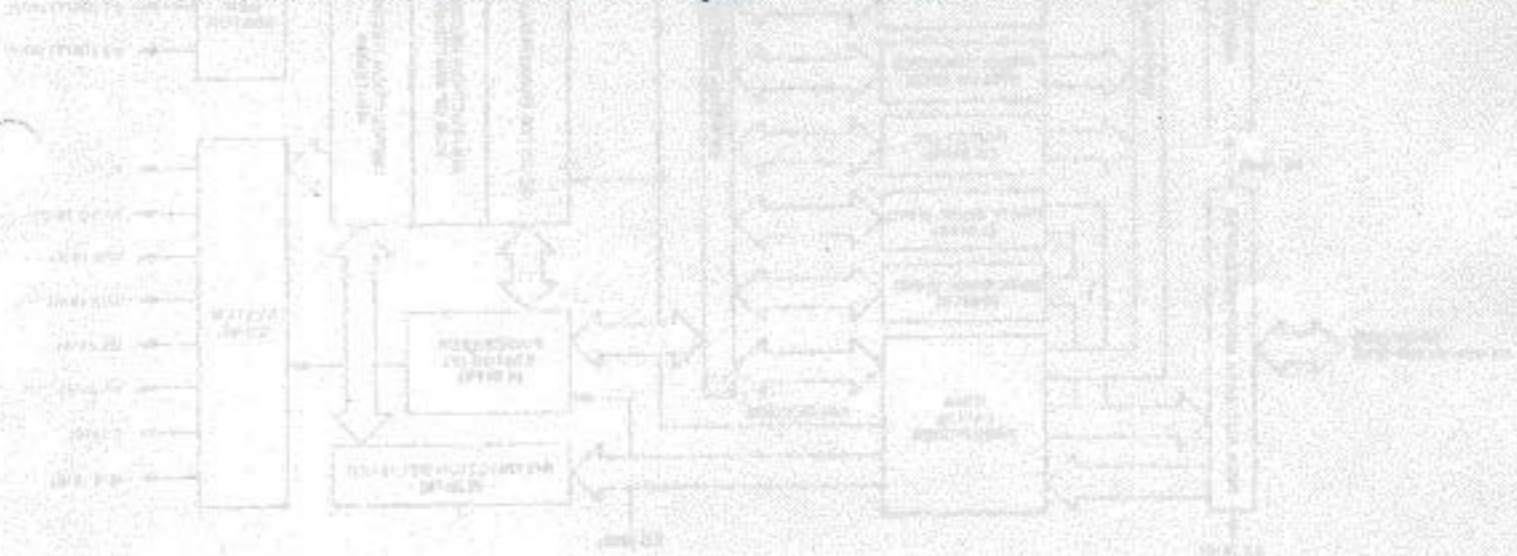

Figure 1-1 W65C832 Internal Architecture Simplified Block Diagram

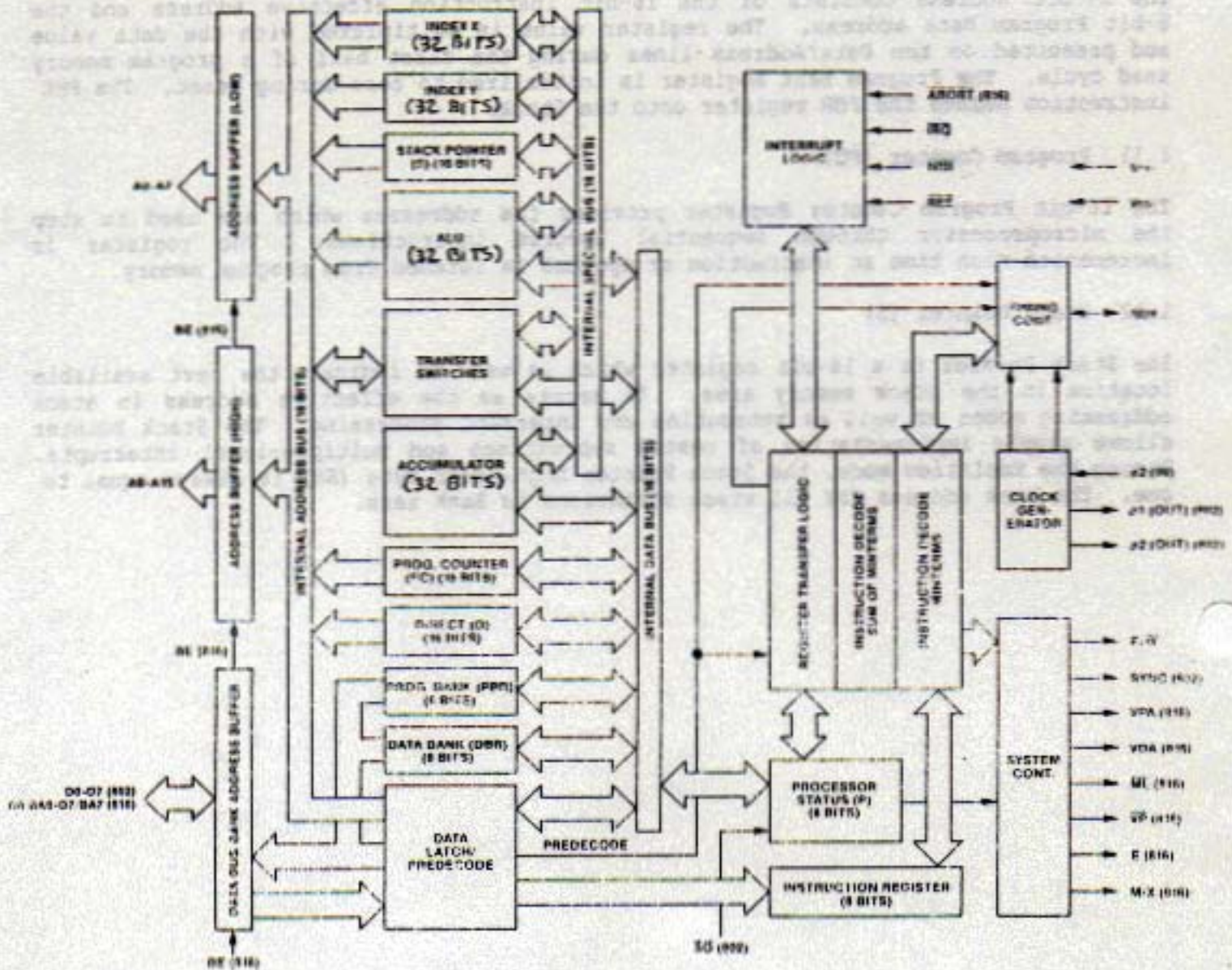
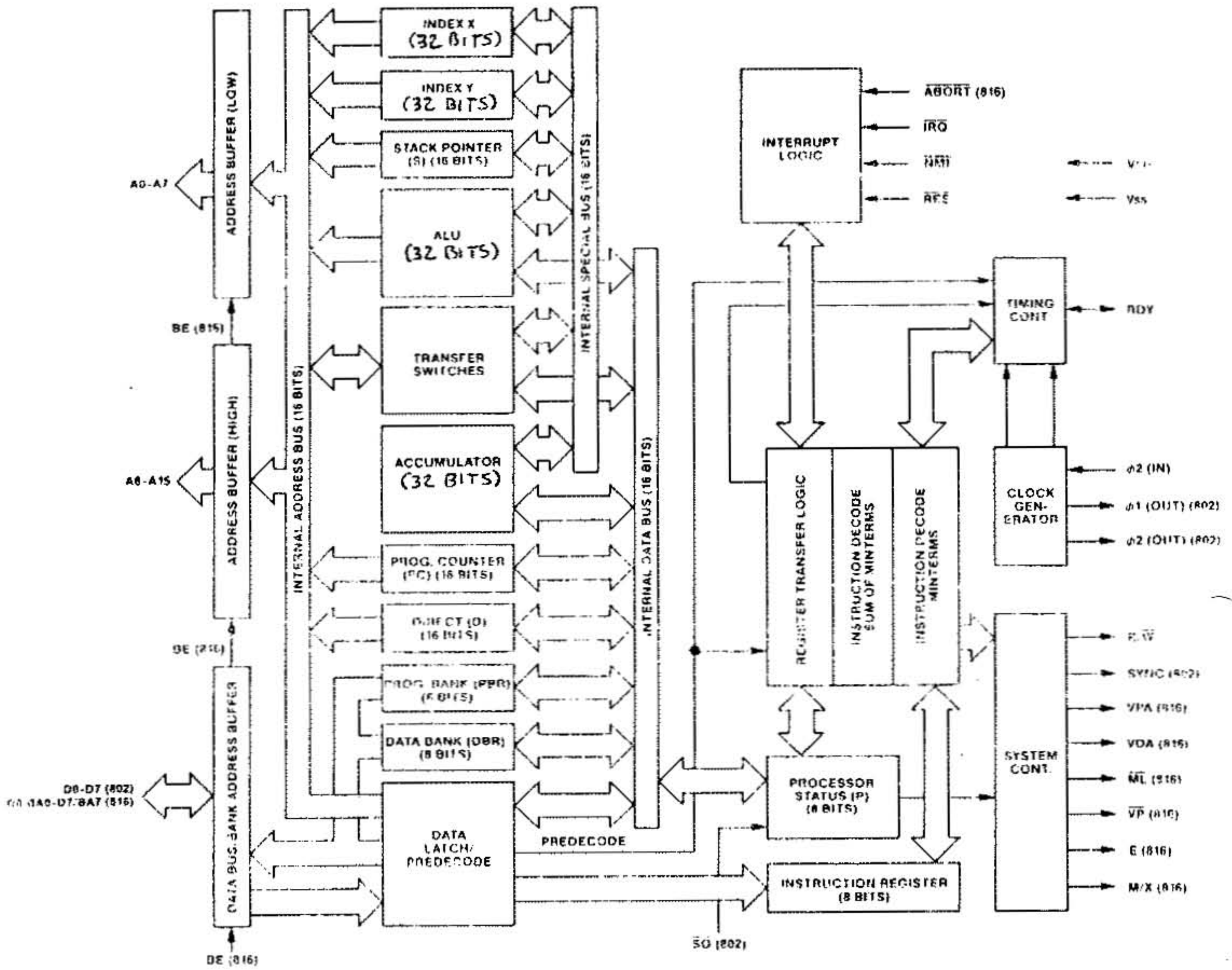

Figure 1-1 W65C832 Internal Architecture Simplified Block Diagram



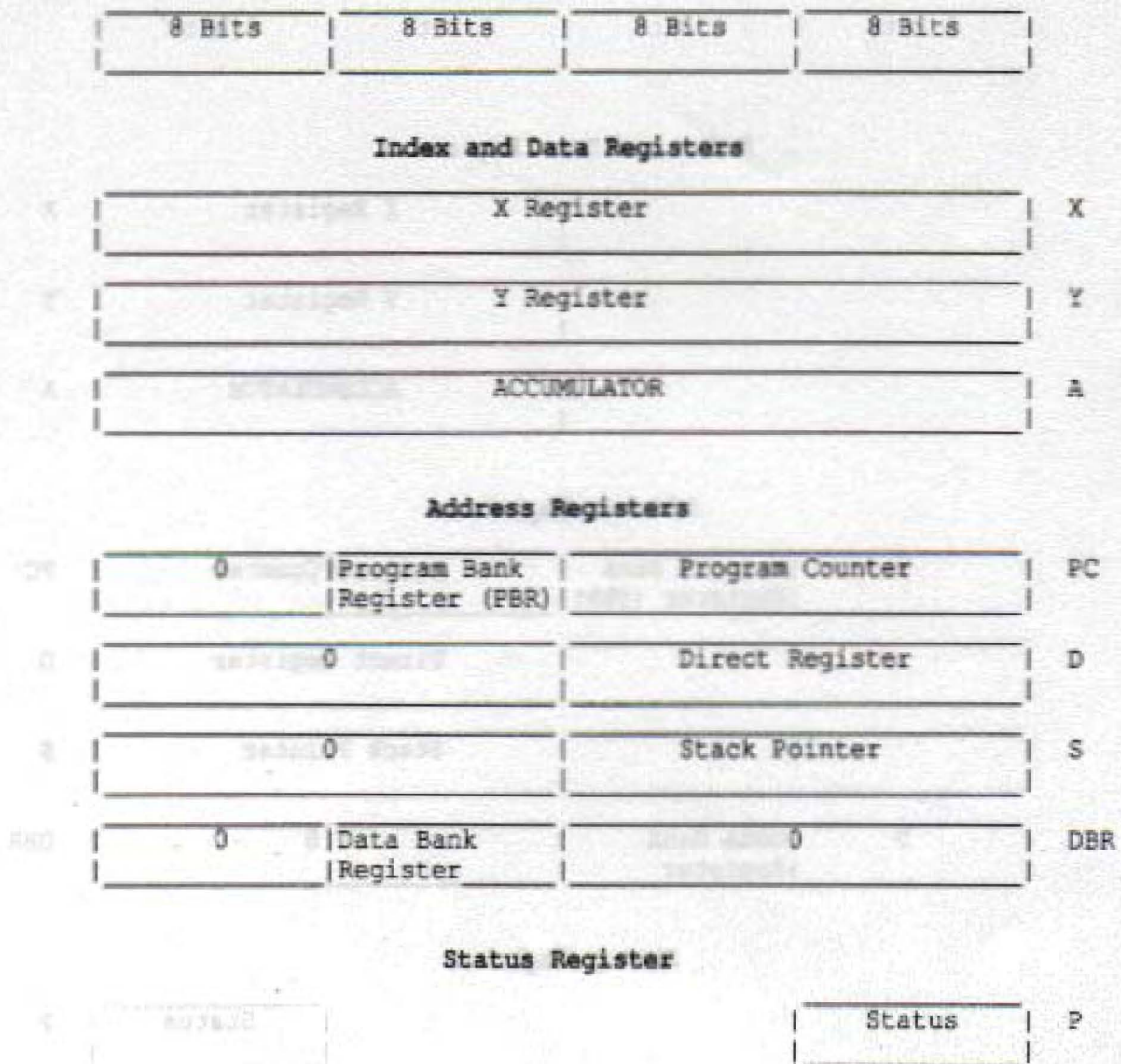
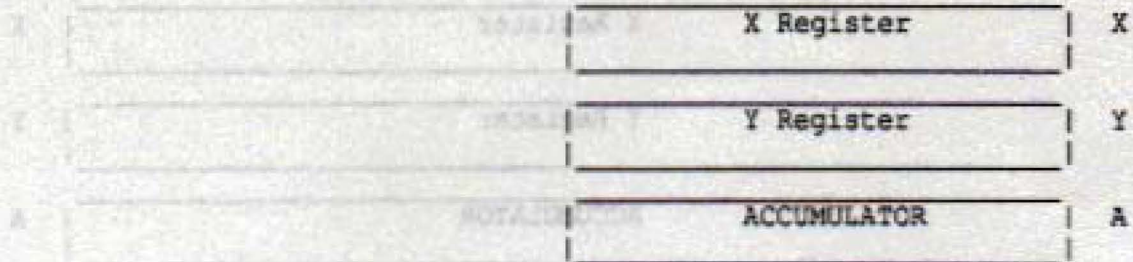

Figure 1-2 W65C832 Native Mode Programming Model



Index and Data Registers



Address Registers

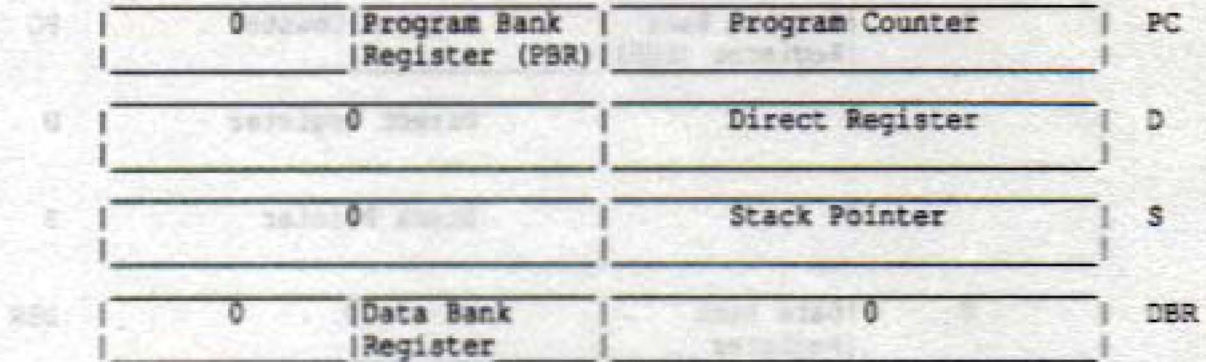

Status Register



Figure 1-3 W65C816 16-bit Emulation Programming Model



Index and Data Registers

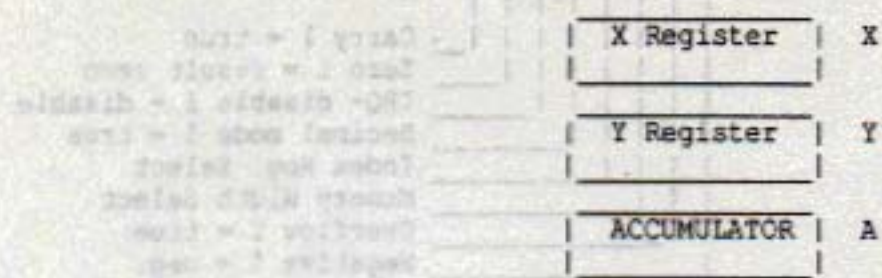

Address Registers

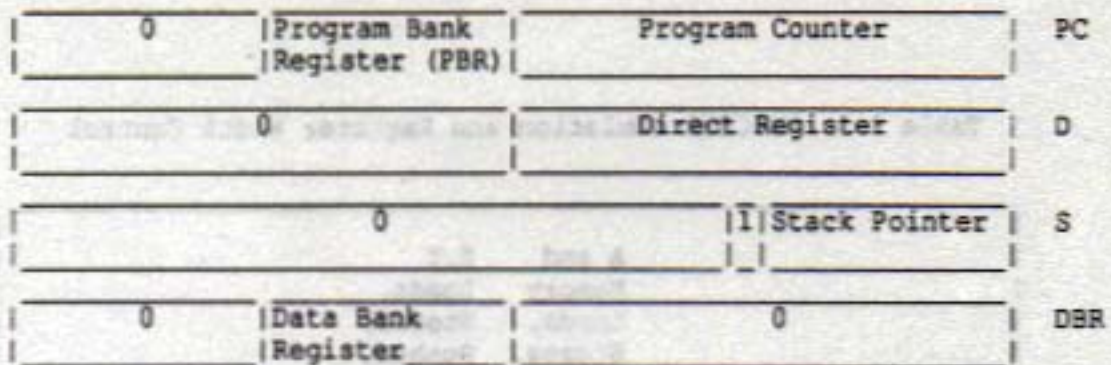

Status Register



Figure 1-4 W65C02 8-bit Emulation Programming Model

W65C02	8	16	1	1	1	1	1
W65C01	8	16	1	1	1	1	1
W65C00	8	16	1	1	1	1	1
W65C03	8	16	1	1	1	1	1
W65C04	8	16	1	1	1	1	1
W65C05	8	16	1	1	1	1	1
W65C06	8	16	1	1	1	1	1
W65C07	8	16	1	1	1	1	1
W65C08	8	16	1	1	1	1	1
W65C09	8	16	1	1	1	1	1
W65C10	8	16	1	1	1	1	1
W65C11	8	16	1	1	1	1	1
W65C12	8	16	1	1	1	1	1
W65C13	8	16	1	1	1	1	1
W65C14	8	16	1	1	1	1	1
W65C15	8	16	1	1	1	1	1

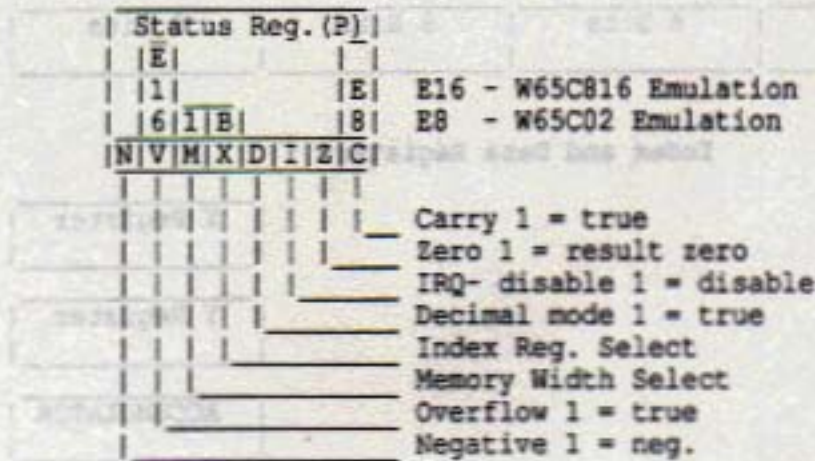

Figure 1-5 W65C832 Status Register Coding

Table 1-1 W65C832 Emulation and Register Width Control

E16	E8	M	X	A and Memory Loads, Stores, Pushes, and Pulls	X, Y Loads, Stores, Pushes, and Pulls	Address Generation	Emulation Mode
0	0	0	0	16	32		W65C832 Native
0	0	0	1	16	8		W65C832 Native
0	0	1	0	8	32		W65C832 Native
0	0	1	1	8	8		W65C832 Native
0	1	0	0	32	32		W65C832 Native
0	1	0	1	32	8		W65C832 Native
0	1	1	0	8	32		W65C832 Native
0	1	1	1	8	8		W65C832 Native
1	0	0	0	16	16		W65C816 Emulation
1	0	0	1	16	8		W65C816 Emulation
1	0	1	0	8	16		W65C816 Emulation
1	0	1	1	8	8		W65C816 Emulation
1	1	1	BRK	8	8		W65C02 Emulation

SECTION 2

PIN FUNCTION DESCRIPTION

		W65C832											
		M	I	A	R	V	V	R	V	M	P		
		L	R	B	R	P	S	E	D	/	H	I	B
		-	-	-	Y	-	S	-	A	X	2	E	E
		6	5	4	3	2	1	44	43	42	41	40	
NMI-	7											39	E8/E16
VPA	8											38	R/W-
VDD	9											37	VDD
A0	10											36	D0/A16
A1	11											35	D1/A17
VSS	12											34	D2/A18
A2	13											33	D3/A19
A3	14											32	D4/A20
A4	15											31	D5/A21
A5	16											30	D6/A22
A6	17											29	D7/A23
	18	A	A	A	A	A	V	V	A	A	A	A	
	7	8	9	1	1	S	S	1	1	1	1	1	
				0	1	S	S	2	3	4	5		

Figure 2-1 W65C832 44 Pin PLCC Pinout

Table 2-1 Pin Function Table

Pin	Description
A0-A15	Address Bus
ABORT-	Abort Input
BE	Bus Enable
PHI2(IN)	Phase 2 In Clock
D0/A16-D7/A23	Data Bus/Address Bus
E8/E16	Emulation Select
IRQ-	Interrupt Request
ML-	Memory Lock
M/X	Mode Select (Pm or Px)
NMI-	Non-Maskable Interrupt
RDY	Ready
RES-	Reset
R/W-	Read/Write
VDA	Valid Data Address
VP-	Vector Pull
VPA	Valid Program Address
VDD	Positive Power Supply (+5 volts)
VSS	Internal Logic Ground

2.1 Abort (ABORT-)

The Abort input is used to abort instructions (usually due to an Address Bus condition). A negative transition will inhibit modification of any internal register during the current instruction. Upon completion of this instruction, an interrupt sequence is initiated. The location of the aborted opcode is stored as the return address in stack memory. The Abort vector address is 00FFF8,9 (Emulation mode) or 00FFE8,9 (Native mode). Note that ABORT- is a pulse-sensitive signal; i.e., an abort will occur whenever there is a negative pulse (or level) on the ABORT- pin during a PHI2 clock.

2.2 Address Bus (A0-A15)

These sixteen output lines form the low 16 bits of the Address Bus for memory and I/O exchange on the Data Bus. The address lines may be set to the high impedance state by the Bus Enable (BE) signal.

2.3 Bus Enable (BE)

The Bus Enable input signal allows external control of the Address and Data Buffers, as well as the R/W- signal. With Bus Enable high, the R/W- and Address Buffers are active. The Data/Address Buffers are active during the first half of every cycle and the second half of a write cycle. When BE is low, these buffers are disabled. Bus Enable is an asynchronous signal.

2.4 Data/Address Bus (D0/A16-D7/A23)

These eight lines multiplex address bits A16-A23 with the data value D0-D7. The address is present during the first half of a memory cycle, and the data value is read or written during the second half of the memory cycle. Four memory cycles are required to transfer 32-bit values. These lines may be set to the high impedance state by the Bus Enable (BE) signal.

2.5 Emulation Status (E8/E16)

The Emulation Status output E8/E16 reflects the state of the Emulation E8 and E16 mode flags in the Processor Status (P) Register. This signal may be thought of as an opcode extension and used for memory and system management.

2.6 Interrupt Request (IRQ-)

The Interrupt Request input signal is used to request that an interrupt sequence be initiated. When the IRQ Disable (I) flag is cleared, a low input logic level initiates an interrupt sequence after the current instruction is completed. The Wait-for-Interrupt (WAI) instruction may be executed to ensure the interrupt will be recognized immediately. The Interrupt Request vector address is 00FFFE,F (Emulation mode) or 00FFEE,F (Native mode). Since IRQ- is a level-sensitive input, an interrupt will occur if the interrupt source was not cleared since the last interrupt. Also, no interrupt will occur if the interrupt source is cleared prior to interrupt recognition.

2.7 Memory Lock (ML-)

The Memory Lock output may be used to ensure the integrity of Read-Modify-Write instructions in a multiprocessor system. Memory Lock indicates the need to defer arbitration of the next bus cycle. Memory Lock is low during the last three, five or nine cycles of ASL, DEC, INC, LSR, ROL, ROR, TRB, and TSB memory referencing instructions, depending on the state of the M and E8 flags.

2.8 Memory/Index Select Status (M/X)

This multiplexed output reflects the state of the Accumulator (M) and Index (X) select flags (bits 5 and 4 of the Processor Status (P) Register). Flag M is valid during the Phase 2 clock negative transition and Flag X is valid during the Phase 2 clock positive transition. These bits may be thought of as opcode extensions and may be used for memory and system management.

2.9 Non-Maskable Interrupt (NMI-)

A negative transition on the NMI- input initiates an interrupt sequence. A high-to-low transition initiates an interrupt sequence after the current instruction is completed. The Wait for Interrupt (WAI) instruction may be executed to ensure that the interrupt will be recognized immediately. The Non-Maskable Interrupt vector address is 00FFFA,B (8-bit Emulation mode), 00FFEA,B (16-bit Emulation mode) or 00FFDA,B (Native mode). Since NMI- is an edge-sensitive input, an interrupt will occur if there is a negative transition while servicing a previous interrupt. Also, no interrupt will occur if NMI- remains low.

2.10 Phase 2 In (PHI2)

This is the system clock input to the microprocessor internal clock generator. During the low power Standby Mode, PHI2 may be held in the high or low state to preserve the contents of internal registers. However, usually it is held in the high state.

2.11 Read/Write (R/W-)

When the R/W- output signal is in the high state, the microprocessor is reading data from memory or I/O. When in the low state, the Data Bus contains valid data from the microprocessor which is to be stored at the addressed memory location. The R/W- signal may be set to the high impedance state by Bus Enable (BE).

2.12 Ready (RDY)

This bidirectional signal indicates that a Wait for Interrupt (WAI) instruction has been executed allowing the user to halt operation of the microprocessor. A low input logic level will halt the microprocessor in its current state. Returning RDY to the active high state allows the microprocessor to continue following the next PHI2 Clock negative transition. The RDY signal is internally pulled low following the execution of a Wait for Interrupt (WAI) instruction, and then returned to the high state when a RES-, ABORT-, NMI-, or IRQ- external interrupt is provided. This feature may be used to eliminate interrupt latency by placing the WAI instruction at the beginning of the IRQ- servicing routine. If the IRQ- Disable flag has been set, the next instruction will be executed when the IRQ- occurs. The processor will not stop after a WAI instruction if RDY has been forced to a high state. However, this feature should only be used on ASIC's and the RDY buffer modified. The Stop (STP) instruction has no effect on RDY.

2.13 Reset (RES-)

The Reset input is used to initialize the microprocessor and start program execution. The Reset input buffer has hysteresis such that a simple R-C timing circuit may be used with the internal pullup device. The RES- signal must be held low for at least two clock cycles after VDD reaches operating voltage. Ready (RDY) has no effect while RES- is being held low. During the Reset conditioning period, the following period, the following processor initialization takes place:

		Registers										
D	=	0000								SH	=	01
DBR	=	00								XH	=	00
PBR	=	00								YH	=	00

		N	V/E16	M	X	D	I	Z	C/ES		
P	=	*	*/1	1	1	0	1	*	*/1	*	= not initialized

STP and WAI instructions are cleared.

		Signals					
E8	=	1			VDA	=	0
E16	=	1			VP-	=	1
M/X	=	1			VPA	=	0
R/W-	=	1					
SYNC	=	0					

When Reset is brought high, an interrupt sequence is initiated:

- o R/W- remains in the high state during the stack address cycles.
- o The Reset vector address is 00FFFC,D.

2.14 Valid Data Address (VDA) and Valid Program Address (VPA)

These two output signals indicate valid memory addresses when high logic 1, and are used for memory or I/O address qualification.

VDA	VPA	
0	0	Internal Operation-Address and Data Bus available. The Address Bus may be invalid.
0	1	Valid program address-may be used for program cache control.
1	0	Valid data address-may be used for data cache control.
1	1	Opcode fetch-may be used for program cache control and single step control

2.15 VDD and VSS

VDD is the positive supply voltage and VSS is system logic ground.

2.16 Vector Pull (VP-)

The Vector Pull output indicates that a vector location is being addressed during an interrupt sequence. VP- is low during the last two interrupt sequence cycles, during which time the processor reads the interrupt vector. The VP- signal may be used to select and prioritize interrupts from several sources by modifying the vector addresses.

SECTION 3

ADDRESSING MODES

The W65C832 is capable of directly addressing 16 MBytes of memory for program space and 4GBytes for data space although only 24 bits (16MBytes) of address space are available on the standard product. This address space has special significance within certain addressing modes, as follows:

3.1 Reset and Interrupt Vectors

The Reset and Interrupt Vectors use the majority of the fixed addresses between 00FFD0 and 00FFFF.

3.2 Stack

The Stack may use memory from 000000 to 00FFFF. The effective address of Stack and Stack Relative addressing modes will be always be within this range.

3.3 Direct

The Direct addressing modes are usually used to store memory registers and pointers. The effective address generated by Direct, Direct,X and Direct,Y addressing modes is always in Bank 0 (000000-00FFFF).

3.4 Program Address Space

The Program Bank register is not affected by the Relative, Relative Long, Absolute, Absolute Indirect, and Absolute Indexed Indirect addressing modes or by incrementing the Program Counter from FFFF. The only instructions that affect the Program Bank register are: RTI, RTL, JML, JSL, and JMP Absolute Long. Program code may exceed 64K bytes although code segments may not span bank boundaries.

3.5 Data Address Space

The Data Address space is contiguous throughout the 16 MByte address space. Words, arrays, records, or any data structures may span 64 KByte bank boundaries with no compromise in code efficiency. The following addressing modes generate 24-bit effective addresses in W65C816 Emulation mode and some, where noted by (*), generate 32-bit effective address in W65C832 native mode.

- o Direct Indexed Indirect (d,x)
- * Direct Indirect Indexed (d),y
- o Direct Indirect (d)
- o Direct Indirect Long [d]
- * Direct Indirect Long Indexed [d],y
- o Absolute a
- * Absolute a,x
- * Absolute a,y
- o Absolute Long al
- * Absolute Long Indexed al,x
- * Stack Relative Indirect Indexed (d,x),y

The following addressing mode descriptions provide additional detail as to how effective addresses are calculated.

Twenty-four addressing modes are available for the W65C832. The 32-bit indexed addressing modes are used with the W65C832; however, the high byte of the address is not available to the hardware on the standard W65C832 but is available on the core for ASIC's. Detailed descriptions of the 24 addressing modes are as follows:

3.5.1 Immediate Addressing-#

The operand is the second byte in 8-bit mode, second and third bytes when in the 16-bit mode, or 2nd thru 5th bytes in 32-bit mode of the instruction.

3.5.2 Absolute-a

With Absolute addressing the second and third bytes of the instruction form the low-order 16 bits of the effective address. The Data Bank Register contains the high-order 8 bits of the operand address.

Instruction: | opcode | addr1 | addrh |

Operand

Address: | DBR | addrh | addr1 |

3.5.3 Absolute Long-al

Instruction: | opcode | addr1 | addrh | baddr |

Operand

Address: | baddr | addrh | addr1 |

3.5.4 Direct-d

The second byte of the instruction is added to the Direct Register (D) to form the effective address. An additional cycle is required when the Direct Register is not page aligned (DL not equal 0). The Bank register is always 0.

Instruction: | opcode | offset |

Operand | Direct Register |

Address: | 00 | + | offset |

| effective address |

3.5.5 Accumulator-A

This form of addressing always uses a single byte instruction. The operand is the Accumulator.

3.5.6 Implied-i

Implied addressing uses a single byte instruction. The operand is implicitly defined by the instruction.

* 3.5.7 Direct Indirect Indexed-(d),y

This address mode is often referred to as Indirect,Y. The second byte of the instruction is added to the Direct Register (D). The 16-bit contents of this memory location is then combined with the Data Bank register to form a 24-bit base address. The Y Index Register is added to the base address to form the effective address. In native mode this creates 32-bit effective addresses.

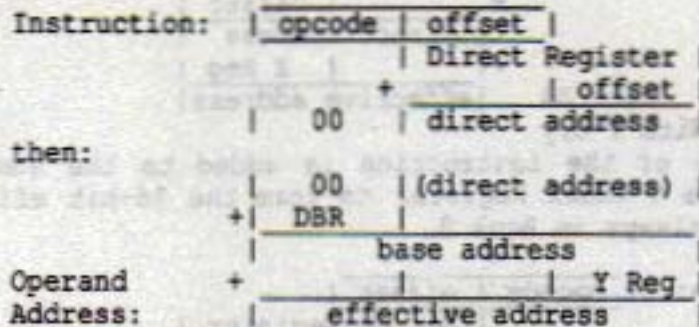

* 3.5.8 Direct Indirect Long Indexed-[d],y

With this addressing mode, the 24-bit base address is pointed to by the sum of the second byte of the instruction and the Direct Register. The effective address is this 24-bit base address plus the Y Index Register. In native mode this creates 32-bit effective addresses.

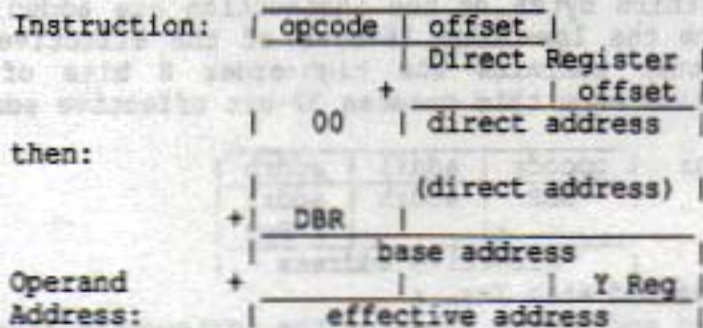

3.5.9 Direct Indexed Indirect-(d,x)

This address mode is often referred to as Indirect,X. The second byte of the instruction is added to the sum of the Direct Register and the X Index Register. The result points to the low-order 16 bits of the effective address. The Data Bank Register contains the high-order 8 bits of the effective address.

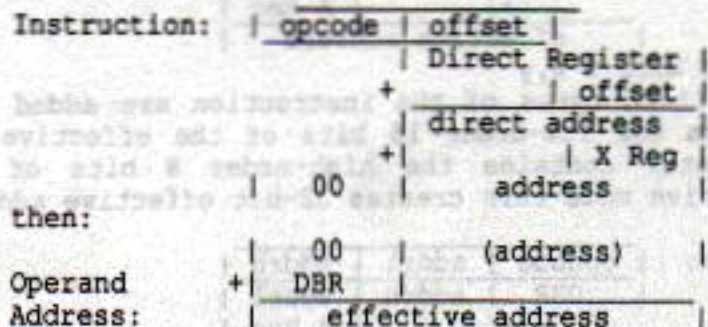

3.5.10 Direct Indexed With X-d,x

The second byte of the instruction is added to the sum of the Direct Register and the X Index Register to form the 16-bit effective address. The operand is always in Bank 0.

Instruction:	opcode	offset
		Direct Register
	+	offset
		direct address
Operand	+	X Reg
Address:	00	effective address

3.5.11 Direct Indexed With Y-d,y

The second byte of the instruction is added to the sum of the Direct Register and the Y Index Register to form the 16-bit effective address. The operand is always in Bank 0.

Instruction:	opcode	offset
		Direct Register
	+	offset
		direct address
Operand	+	Y Reg
Address:	00	effective address

* 3.5.12 Absolute Indexed With X-a,x

The second and third bytes of the instruction are added to the X Index Register to form the low-order 16-bits of the effective address. The Data Bank Register contains the high-order 8 bits of the effective address. In native mode this creates 32-bit effective addresses.

Instruction:	opcode	addrl	addrh
	DBR	addrh	addrl
Operand	+		X Reg
Address:		effective address	

* 3.5.13 Absolute Long Indexed With X-al,x

The second, third and fourth bytes of the instruction form a 24-bit base address. The effective address is the sum of this 24-bit address and the X Index Register. In native mode this creates 32-bit effective addresses.

Instruction:	opcode	addrl	addrh	baddr
	baddr	addrh	addrl	
Operand	+		X Reg	
Address:		effective address		

* 3.5.14 Absolute Indexed With Y-a,y

The second and third bytes of the instruction are added to the Y Index Register to form the low-order 16 bits of the effective address. The Data Bank Register contains the high-order 8 bits of the effective address. In native mode this creates 32-bit effective addresses.

Instruction:	opcode	addrl	addrh
	DBR	addrh	addrl
Operand	+		Y Reg
Address:		effective address	

3.5.15 Program Counter Relative-r

This address mode, referred to as Relative Addressing, is used only with the Branch instructions. If the condition being tested is met, the second byte of the instruction is added to the Program Counter, which has been updated to point to the opcode of the next instruction. The offset is a signed 8-bit quantity in the range from -128 to 127. The Program Bank Register is not affected.

3.5.16 Program Counter Relative Long-rl

This address mode, referred to as Relative Long Addressing, is used only with the Unconditional Branch Long instruction (BRL) and the Push Effective Relative instruction (PER). The second and third bytes of the instruction are added to the Program Counter, which has been updated to point to the opcode of the next instruction. With the branch instruction, the Program Counter is loaded with the result. With the Push Effective Relative instruction, the result is stored on the stack. The offset is a signed 16-bit quantity in the range from -32768 to 32767. The Program Bank Register is not affected.

3.5.17 Absolute Indirect-(a)

The second and third bytes of the instruction form an address to a pointer in Bank 0. The Program Counter is loaded with the first and second bytes at this pointer. With the Jump Long (JML) instruction, the Program Bank Register is loaded with the third byte of the pointer.

```

Instruction: | opcode | addr1 | addrh |
Indirect Address = | 00 | addrh | addr1 |
New PC = (indirect address)
with JML:
New PC = (indirect address)
New PBR = (indirect address +2)

```

3.5.18 Direct Indirect-(d)

The second byte of the instruction is added to the Direct Register to form a pointer to the low-order 16 bits of the effective address. The Data Bank Register contains the high-order 8 bits of the effective address.

```

Instruction: | opcode | offset |
              |         | Direct Register |
              +-----+ | offset |
              | 00 | direct address |
then:
              | 00 | (direct address) |
Operand      +| DBR |
Address:     | effective address |

```

3.5.19 Direct Indirect Long-[d]

The second byte of the instruction is added to the Direct Register to form a pointer to the 24-bit effective address.

```

Instruction: | opcode | offset |
              |         | Direct Register |
              +-----+ | offset |
              | 00 | direct address |
then:
Operand      | (direct address) |
Address:

```

3.5.20 Absolute Indexed Indirect-(a,x)

The second and third bytes of the instruction are added to the X Index Register to form a 16-bit pointer in Bank 0. The contents of this pointer are loaded in the Program Counter. The Program Bank Register is not changed.

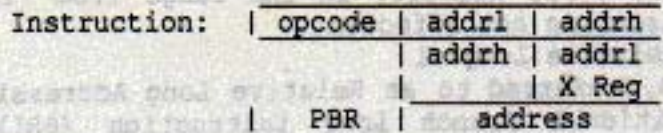

then:

$$PC = \text{address}$$

3.5.21 Stack-s

Stack addressing refers to all instructions that push or pull data from the stack, such as Push, Pull, Jump to Subroutine, Return from Subroutine, Interrupts, and Return from Interrupt. The bank address is always 0. Interrupt Vectors are always fetched from Bank 0.

3.5.22 Stack Relative-d,s

The low-order 16 bits of the effective address is formed from the sum of the second byte of the instruction and the stack pointer. The high-order 8 bits of the effective address is always zero. The relative offset is an unsigned 8-bit quantity in the range of 0 to 255.

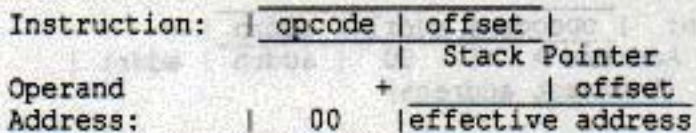

* 3.5.23 Stack Relative Indirect Indexed-(d,s),y

The second byte of the instruction is added to the Stack Pointer to form a pointer to the low-order 16-bit base address in Bank 0. The Data Bank Register contains the high-order 8 bits of the base address. The effective address is the sum of the 24-bit base address and the Y Index Register. In the native mode this creates 32-bit effective addresses.

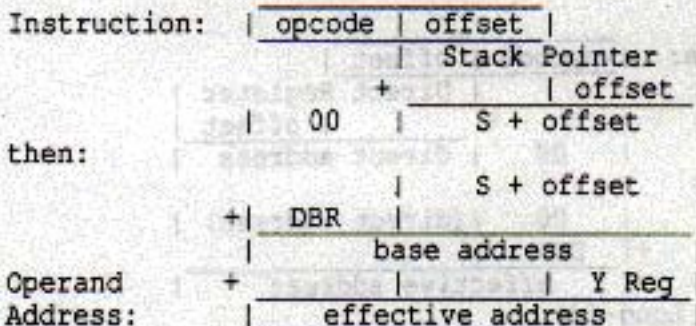

3.5.24 Block Source Bank, Destination Bank-xya

This addressing mode is used by the Block Move instructions. The second byte of the instruction contains the high-order 8 bits of the destination address. The Y Index Register contains the low-order 16 bits of the destination address. The third byte of the instruction contains the high-order 8 bits of the source address. The X Index Register contains the low-order bits of the source address. The Accumulator contains one less than the number of bytes to move. When the Accumulator is zero it will move one byte. The second byte of the block move instructions is also loaded into the Data Bank Register. In W65C832 native mode this X Index Register contains the entire source address and the X Index Register contains the entire destination address; therefore, the instruction is shorter by two bytes and two cycles per byte moved.

Instruction:	opcode	dstbnk	srcbnk	
Source		dstbnk -> DBR		
Address:		srcbnk		X Reg
Destination		DBR		Y Reg
Address:				

Increment (MVN) or decrement (MVP) X and Y.
Decrement C (if greater than zero), then PC+3->PC.

- * In W65C832 native mode these addressing modes creates 32-bit effective data space addresses.

Table 3-1 Address Mode Formats

Addressing Mode	Format	Addressing Mode	Format	
Immediate	#d	Absolute Indexed by Y	!d,y	
	#a		d,y	
	#al		a,y	
	#EXT		!a,y	
	#<d		!al,y	
	#<a		!EXT,y	
	#<al		EXT,y	
	#<EXT		>d,x	
	#>d		>a,x	
	#>a		>al,x	
Absolute	#>al	Absolute Long Indexed by X	al,x	
	#>EXT		>EXT,x	
	#^d		Program Counter Relative and Program Counter Relative Long	d
	#^a			a
	#^al			al
	#^EXT			(EXT)
	!d			(d)
	!a			(!d)
	a			(a)
	!al			(!a)
!EXT	(!al)			
EXT	(EXT)			
Absolute Long	>d	Direct Indirect	(d)	
	>a		<a)	
	>al		<al)	
	al		<EXT)	
Direct Page	>EXT	Direct Indirect Long	d)	
	<d		>a)	
	<a		>al)	
	<al		>EXT)	
Accumulator Implied Addressing	<EXT	Absolute Indexed	(d,x)	
	A		(!d,x)	
	(no operand)		(a,x)	
	{d},y		(!a,x)	
	{<d},y		(!al,x)	
	{<a},y		(EXT,x)	
	{<al},y		(!EXT,x)	
	{<EXT},y		(no operand)	
	d),y		(G,s),y	
	<d),y		(d,s),y	
<a),y	<a,s),y			
<al),y	<al,s),y			
<EXT),y	<EXT,s),y			
Direct Indirect Indexed	(d,x)	Stack Addressing	d,d	
	<d,x)		d,a	
	<a,x)		d,al	
	<al,x)		d,EXT	
Direct Indexed by X	<EXT,x)	Stack Relative Indirect Indexed	a,d	
	d,x		a,a	
	<d,x		a,al	
	<a,x		a,EXT	
Direct Indexed by Y	<al,x	Block Move	al,d	
	<EXT,x		al,a	
	d,y		al,al	
	<d,y		al,EXT	
	<a,y		EXT,d	
	<al,y		EXT,a	
Absolute Indexed by X	<EXT,y	Block Move	EXT,al	
	d,x		EXT,EXT	
	!d,x			
	a,x			
	!a,x			
	!al,x			
Direct Indexed by Y	!EXT,x			
	EXT,x			
	d,x			
	<d,x			
	<a,x			
	<al,x			

Note: The alternate ! (exclamation point) is used in place of the | (vertical bar).

Table 3-2 Addressing Mode Summary

Address Mode	Instruction Times In Memory Cycles		Memory Utilization In Number of Program Sequence Bytes	
	Original	New	Original	New
	8-bit NMOS 6502	W65C832	8-bit NMOS 6502	W65C832
1. Immediate	2	2(3)	2	2(3)
2. Absolute	4(5)	4(3,5)	3	3
3. Absolute Long	-	5(3)	-	4
4. Direct	3(5)	3(3,4,5)	2	2
5. Accumulator	2	2	1	1
6. Implied	2	2	1	1
7. Direct Indirect Indexed (d),y	5(1)	5(1,3,4)	2	2
8. Direct Indirect Indexed Long [d],y	-	6(3,4)	-	2
9. Direct Indexed Indirect (d,x)	6	6(3,4)	2	2
10. Direct,X	4(5)	4(3,4,5)	2	2
11. Direct,Y	4	4(3,4)	2	2
12. Absolute,X	4(1,5)	4(1,3,5)	3	3
13. Absolute Long,X	-	5(3)	-	4
14. Absolute,Y	4(1)	4(1,3)	3	3
15. Relative	2(1,2)	2(2)	2	2
16. Relative Long	-	3(2)	-	3
17. Absolute Indirect (Jump)	5	5	3	3
18. Direct Indirect	-	5(3,4)	-	2
19. Direct Indirect Long	-	6(3,4)	-	2
20. Absolute Indexed Indirect (Jump)	-	6	-	3
21. Stack	3-7	3-11	1-3	1-4
22. Stack Relative	-	4(3)	-	2
23. Stack Relative Indirect Indexed	-	7(3)	-	2
24. Block Move X,Y,C (Source, Destination, Block Length)	-	7(6)	-	3(6)

Notes (these are indicated in parentheses):

1. Page boundary, add 1 cycle if page boundary is crossed when forming address.
2. Branch taken, add 1 cycle if branch is taken.
3. 16 bit operation, add 1 cycle, add 1 byte for immediate.
32 bit operation, add 3 cycles, add 3 bytes for immediate.
4. Direct register low (DL) not equal zero, add 1 cycle.
5. Read-Modify-Write, add 2 cycles for 8-bit, add 4 cycles for 16-bit, add 8 cycles for 32-bit operation.
6. For W65C832 native mode, subtract 2 cycles and 2 bytes.

SECTION 4

TIMING, AC AND DC CHARACTERISTICS

4.1 Absolute Maximum Ratings: (Note 1)

Table 4-1 Absolute Maximum Ratings

Rating	Symbol	Value
Supply Voltage	VDD	-0.3 to +7.0V
Input Voltage	VIN	-0.3 to VDD +0.3V
Operating Temperature	TA	0°C to +70°C
Storage Temperature	TS	-55°C to +150°C

This device contains input protection against damage due to high static voltages or electric fields; however, precautions should be taken to avoid application of voltages higher than the maximum rating.

Notes:

- Exceeding these ratings may result in permanent damage. Functional operation under these conditions is not implied.

4.2 DC Characteristics: VDD = 5.0V +/- 5%,
 VSS = 0V,
 TA = 0°C to +70°C

Table 4-2 DC Characteristics

Parameter	Symbol	Min	Max	Unit
Input High Voltage	Vih			
RES-, RDY, IRQ-, Data, BE		2.0	VDD+0.3	V
PHI2, NMI-, ABORT-		0.9*VDD	VDD+0.3	V
Input Low Voltage	Vil			
RES-, RDY, IRQ-, Data, BE		-0.3	0.8	V
PHI2, NMI-, ABORT-		-0.3	0.1*VDD	V
Input Leakage Current (Vin = 0.4 to 2.4)	Iin			
RES-, NMI-, IRQ-, BE, ABORT- (Internal Pullup)		-100	1	uA
RDY (Internal Pullup, Open Drain)		-100	10	uA
PHI2	Iin	-1	1	uA
Address, Data, R/W-, (Off State, BE=0)		-10	10	uA
Output High Voltage (Ioh=-100uA)	Voh			
Data, Address, R/W-, ML-, VP-, M/X, E8/E16 VDA, VPA		0.7 VDD	-	V
Output Low Voltage (Iol = 1.6mA)	Vol			
Data, Address, R/W-, ML-, VP-, M/X, E8/E16 VDA, VPA		-	0.4	V
Supply Current (No Load)	Idd		4	mA/MHz
Standby Current (No Load, Data Bus = VSS or VDD RES-, NMI-, IRQ-, SO-, BE, ABORT-, PHI2=VDD)	Isb	-	1	uA
Capacitance (Vin=0V, TA=25°C, f=2MHz)				
Logic, PHI2	Cin	-	10	pF
Address, Data, R/W- (Off State)	Cts	-	15	pF

4.3 General AC Characteristics: VDD= 5.0V +/- 5%, VSS= 0V,
Ta= 0oC to +70oC

Table 4-3A W65C832 General AC Characteristics, 4-7MHz

Parameter	Symbol	4 MHz		5 MHz		6 MHz		7 MHz		Unit
		Min	Max	Min	Max	Min	Max	Min	Max	
Cycle Time	tCYC	250	DC	200	DC	165	DC	140	DC	nS
Clock Pulse Width Low	tPWL	.125	10	.10	10	.082	10	.07	10	uS
Clock Pulse Width High	tPWH	125		100	-	82		70	-	nS
Fall Time, Rise Time	tF, tR	-	10	-	10	-	5	-	5	nS
A0-A15 Hold Time	tAH	10	-	10	-	10	-	10	-	nS
A0-A15 Setup Time	tADS	-	75	-	67	-	60	-	60	nS
A16-A23 Hold Time	tBH	10	-	10	-	10	-	10	-	nS
A16-A23 Setup Time	tBAS	-	90	-	77	-	65	-	55	nS
Access Time	tACC	130	-	115	-	87	-	60	-	nS
Read Data Hold Time	tDHR	10	-	10	-	10	-	10	-	nS
Read Data Setup Time	tDSR	30	-	25	-	20	-	25	-	nS
Write Data Delay Time	tMDS	-	70	-	65	-	60	-	55	nS
Write Data Hold Time	tDHW	10	-	10	-	10	-	10	-	nS
Processor Control Setup Time	tPCS	30	-	25	-	20	-	20	-	nS
Processor Control Hold Time	tPCH	10	-	10	-	10	-	10	-	nS
E8/E16, MX Output Hold Time	tEH	10	-	10	-	5	-	5	-	nS
E8/E16, MX Output Setup Time	tES	50	-	37	-	25	-	25	-	nS
Capacitive Load *1	CEXT	-	100	-	100	-	35	-	35	pF
BE to Valid Data *2	tBVD	-	30	-	30	-	30	-	30	nS

Table 4-3B W65C832 General AC Characteristics, 8-10MHz

Parameter	Symbol	8 MHz		9 MHz		10 MHz		Unit
		Min	Max	Min	Max	Min	Max	
Cycle Time	tCYC	125	DC	110	DC	100	DC	nS
Clock Pulse Width Low	tPWL	.062	10	.055	10	.05	10	uS
Clock Pulse Width High	tPWH	62	-	55	-	50	-	nS
Fall Time, Rise Time	tF, tR	-	5	-	5	-	5	nS
A0-A15 Hold Time	tAH	10	-	10	-	10	-	nS
A0-A15 Setup Time	tADS	-	40	-	40	-	40	nS
A16-A23 Hold Time	tBH	10	-	10	-	10	-	nS
A16-A23 Setup Time	tBAS	-	45	-	45	-	45	nS
Access Time	tACC	70	-	70	-	70	-	nS
Read Data Hold Time	tDHR	10	-	10	-	10	-	nS
Read Data Setup Time	tDSR	15	-	15	-	15	-	nS
Write Data Delay Time	tMDS	-	40	-	40	-	40	nS
Write Data Hold Time	tDHW	10	-	10	-	10	-	nS
Processor Control Setup Time	tPCS	15	-	15	-	15	-	nS
Processor Control Hold Time	tPCH	10	-	10	-	10	-	nS
E8/E16, MX Output Hold Time	tEH	5	-	5	-	5	-	nS
E8/E16, MX Output Setup Time	tES	15	-	15	-	15	-	nS
Capacitive Load *1	CEXT	-	35	-	35	-	35	pF
BE to Valid Data	tBVD	-	30	-	30	-	30	nS

*1 Applies to Address, Data, R/W

*2 BE to High Impedance State is not testable but should be the same amount of time as BE to Valid Data

4.4 General AC Characteristics: VDD= 1.2V, VSS= 0V,
Ta= 0°C to +70°C

Table 4-4A W65C832 General AC Characteristics, 40 KHz

Parameter	Symbol	40 KHz		Unit
		Min	Max	
Cycle Time	tCYC	-	25	µS
Clock Pulse Width Low	tPWL	12.5	13	µS
Clock Pulse Width High	tPWH	12.5	-	µS
Fall Time, Rise Time	tF, tR	-	10	nS
A0-A15 Hold Time	tAH	10	-	nS
A0-A15 Setup Time	tADS	-	2	µS
AA0-A23 Hold Time	tBH	10	-	nS
A16-A23 Setup Time	tBAS	-	2	µS
Access Time	tACC	35	-	µS
Read Data Hold Time	tDHR	100	-	nS
Read Data Setup Time	tDSR	1.5	-	µS
Write Data Delay Time	tMDS	-	2	µS
Write Data Hold Time	tDHW	10	-	nS
Processor Control Setup Time	tPCS	1.5	-	µS
Processor Control Hold Time	tPCH	100	-	nS
E8/E16, MX Output Hold Time	tEH	10	-	nS
E8/E16, MX Output Setup Time	tES	100	-	nS
Capacitive Load *1	CEXT	-	100	pF
BE to Valid Data *2	tBVD	-	30	nS

*1 Applied to Address, Data, R/W

*2 BE to High Impedance State is not testable but should be the same amount of time as BE to Valid Data

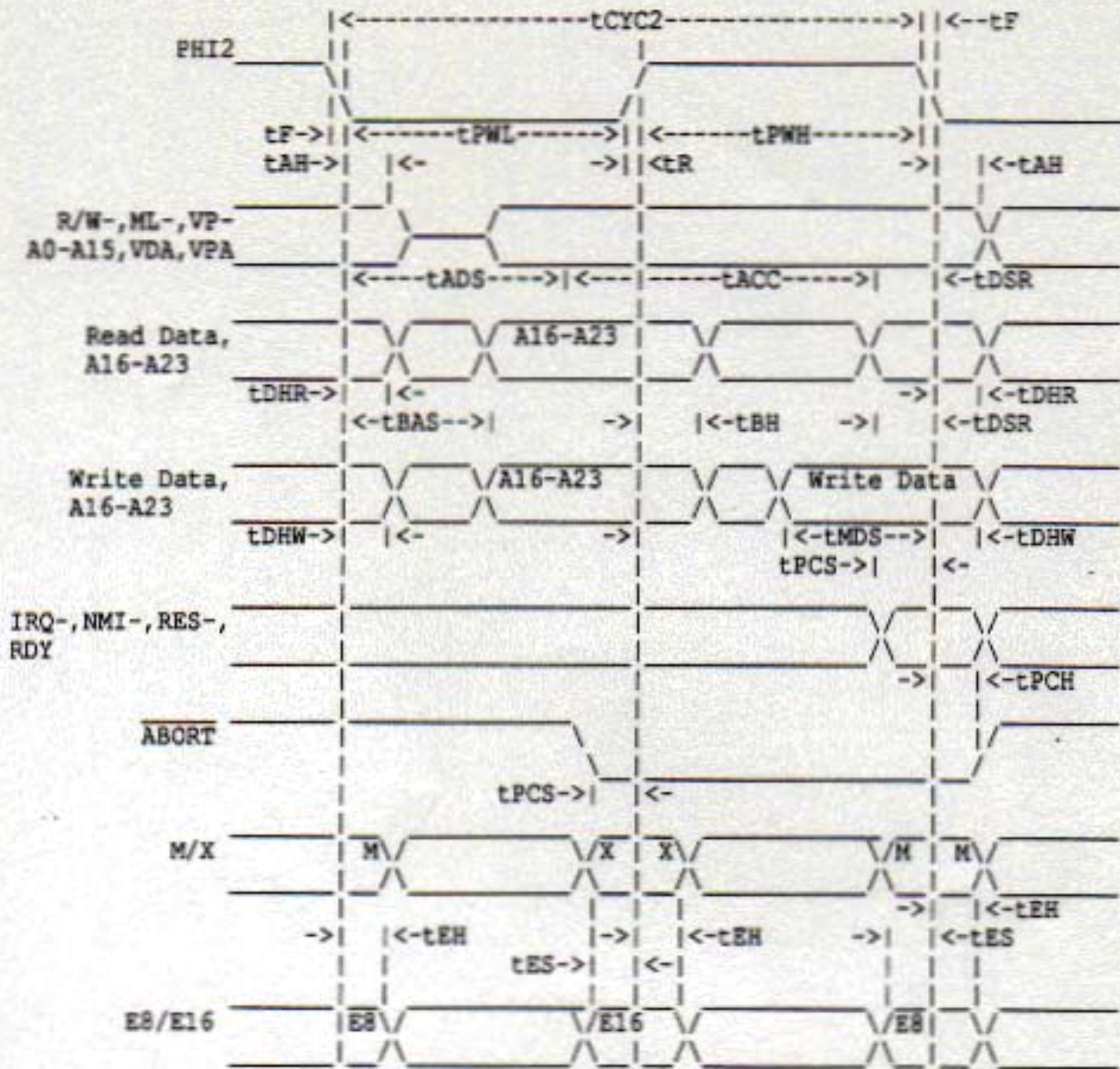

Timing Notes:

1. Voltage levels are $V_L < 0.4V$, $V_H > 2.4V$.
2. Timing measurement points are 0.8V and 2.0V.

Figure 4-1 General Timing Diagram

SECTION 5

ORDERING INFORMATION

	W	65C832	PL	-8
Description				
W-Standard				
Product Identification Number				
Package				
PL-44 leaded plastic chip carrier				
Temperature/Processing				
Blank- 0oC to +70oC				
Performance Designator				
Designators selected for speed and power.				
-4 4MHz -6 6MHz -8 8MHz -10 10MHz -E Experimental				

General sales or technical assistance, and information about devices supplied to a custom specification may be requested from:

The Western Design Center, Inc.
 2166 East Brown Road
 Mesa, Arizona 85213
 Phone: 602-962-4545 Fax: 602-835-6442

WARNING:

MOS CIRCUITS ARE SUBJECT TO DAMAGE FROM STATIC DISCHARGE

Internal static discharge circuits are provided to minimize part damage due to environmental static electrical charge build-ups. Industry established recommendations for handling MOS circuits include:

1. Ship and store product in conductive shipping tubes or conductive foam plastic. Never ship or store product in non-conductive plastic containers or non-conductive plastic foam material.
2. Handle MOS parts only at conductive work stations.
3. Ground all assembly and repair tools.

SECTION 6

APPLICATION INFORMATION

Table 6-1 W65C832 Instruction Set-Alphabetical Sequence

ADC	Add Memory to Accumulator with Carry	PHA	Push Accumulator on Stack
AND	"AND" Memory with Accumulator	PHB	Push Data Bank Register on Stack
ASL	Shift One Bit	PHD	Push Direct Register on Stack
BCC	Branch on Carry Clear (Pc=0)	PHK	Push Program Bank Register on Stack
BCS	Branch on Carry Set (Pc=1)	PHP	Push Processor Status on Stack
BEQ	Branch if Equal (Pr=1)	PHX	Push Index X on Stack
BIT	Bit Test	PHY	Push Index Y on Stack
BMI	Branch if Result Minus (Pn=1)	PLA	Pull Accumulator from Stack
BNE	Branch if Not Equal (Pr=0)	PLB	Pull Data Bank Register from Stack
BPL	Branch if Result Plus (Pn=0)	PLD	Pull Direct Register from Stack
BRA	Branch Always	PLP	Pull Processor Status from Stack
BRK	Force Break	PLX	Pull Index X from Stack
BRL	Branch Always Long	PLY	Pull Index Y from Stack
BVC	Branch on Overflow Clear (Pv=0)	REP	Reset Status Bits
BVS	Branch on Overflow Set (Pv=1)	ROL	Rotate One Bit Left (Memory or Accumulator)
CLC	Clear Carry Flag	ROR	Rotate One Bit Right (Memory or Accumulator)
CLD	Clear Decimal Mode	RTI	Return from Interrupt
CLI	Clear Interrupt Disable Bit	RTL	Return from Subroutine Long
CLV	Clear Overflow Flag	RTS	Return from Subroutine
CMP	Compare Memory and Accumulator	SBC	Subtract Memory from Accumulator with Borrow
COP	Coprocessor	SEP	Set Processor Status Bite
CPX	Compare Memory and Index X	STA	Store Accumulator in Memory
CPY	Compare Memory and Index Y	STP	Stop the Clock
DEC	Decrement Memory or Accumulator by One	STX	Store Index X in Memory
DEX	Decrement Index X by One	STY	Store Index Y in Memory
DEY	Decrement Index Y by One	STZ	Store Zero in Memory
EOR	"Exclusive OR" Memory with Accumulator	TAX	Transfer Accumulator to Index X
INC	Increment Memory or Accumulator by One	TAY	Transfer Accumulator to Index Y
INX	Increment Index X by One	TCD	Transfer C Accumulator to Direct Register
INY	Increment Index Y by One	TCS	Transfer C Accumulator to Stack Pointer Register
JML	Jump Long	TDC	Transfer Direct Register to C Accumulator
JMP	Jump to New Location	TRB	Test and Reset Bit
JSL	Jump Subroutine Long	TSB	Test and Set Bit
JSR	Jump to New Location Saving Return	TSC	Transfer Stack Pointer Register to C Accumulator
LDA	Load Accumulator with Memory	TSX	Transfer Stack Pointer Register to Index X
LDX	Load Index X with Memory	TXA	Transfer Index X to Accumulator
LDY	Load Index Y with Memory	TXS	Transfer Index X to Stack Pointer Register
LSR	Shift One Bit Right (Memory or Accumulator)	TXY	Transfer Index X to Index Y
MVN	Block Move Negative	TYA	Transfer Index Y to Accumulator
MVP	Block Move Positive	TYX	Transfer Index Y to Index X
NOP	No Operation	WAI	Wait for Interrupt
ORA	"OR" Memory with Accumulator	WDM	Reserved for Future Use
PEA	Push Effective Absolute Address on Stack	XBA	Exchange B and A Accumulator
PEI	Push Effective Absolute Address on stack	XCE	Exchange Carry and Emulation E8
PER	Push Effective Program Counter Relative Address on Stack	XFE	Exchange Carry and Emulation E8 and Exchange Overflow and Emulation E16

For alternate mnemonics, see Table 7-3-1.

Table 6-2 Vector Locations

W65C02 8- Emulation		W65C816 16-bit Emulation	
00FFFE, F-IRQ-/BRK	Hardware/Software	00FEE, F-IRQ-	Hardware
00FFFC, D-RESET-	Hardware	00FEC, D- (Reserved)	
00FFFA, C-NMI-	Hardware	00FEA, B-NMI-	Hardware
00FFF8, 9-ABORT-	Hardware	00FE8, 9-ABORT-	Hardware
00FFF6, 7- (Reserved)		00FE6, 7-BRK	Software
00FFF4, 5-COP	Software	00FE4, 5-COP	Software
W65C832 Native			
00FFDE, F-IRQ-	Hardware		
00FFDC, D- (Reserved)			
00FFDA, B-NMI-	Hardware		
00FFD8, 9-ABORT-	Hardware		
00FFD6, 7-BRK	Software		
00FFD4, 5-COP	Software		

The VP output is low during the two cycles used for vector location access. When an interrupt is executed, D=0 and I=1 in Status Register P.

Table 6-3 Opcode Matrix

MSD	LSD																MSD
	0	1	2	3	4	5	6	7	8	9	A	B	C	D	E	F	
0	BRK s 2 8	ORA (d,x) 2 8	COP s 2 * 8	ORA d,s 2 * 4	TSB d 2 * 5	ORA d 2 3	ASL d 2 5	ORA (d) 2 * 6	PHP s 1 3	ORA s 2 2	ASL A 1 2	PHD s 1 * 4	TSB s 3 * 5	ORA s 3 4	ASL s 3 6	ORA s 4 * 5	
1	SPL r 2 2	ORA (d,y) 2 5	ORA (d) 2 * 5	ORA (d,s,y) 2 * 7	TRB d 2 * 5	ORA d,x 2 4	ASL d,x 2 6	ORA (d,y) 2 * 6	CLC i 1 2	ORA s,y 3 4	INC A 1 * 2	TCS i 1 * 2	TRB s 3 * 6	ORA s,x 3 4	ASL s,x 3 7	ORA s,x 4 * 5	
2	JSR s 3 6	AND (d,x) 2 8	JSL s 4 * 5	AND (d,s) 2 * 4	BIT d 2 3	AND d 2 3	ROL d 2 5	AND (d) 2 * 6	PLP s 1 4	AND s 2 2	ROL A 1 2	PLD s 1 * 5	BIT s 3 4	AND s 3 4	ROL s 3 6	AND s 4 * 5	
3	SMR r 2 2	AND (d,y) 2 5	AND (d) 2 * 5	AND (d,s,y) 2 * 7	BIT d,x 2 * 4	AND d,x 2 4	ROL d,x 2 6	AND (d,y) 2 * 6	SEC i 1 2	AND s,y 3 4	DEC A 1 * 2	TSC i 1 * 2	BIT s,x 3 * 4	AND s,x 3 4	ROL s,x 3 7	AND s,x 4 * 5	
4	RTI s 1 7	EOR (d,x) 2 8	WDM 2 * 2	EOR (d,s) 2 * 4	MVP s,y,c 3 * 7	EOR d 2 3	LSR d 2 5	EOR (d) 2 * 6	PHA s 1 3	EOR s 2 2	LSR A 1 2	PHX s 1 * 3	JMP s 3 3	EOR s 3 4	LSR s 3 6	EOR s 4 * 5	
5	BVC r 2 2	EOR (d,y) 2 5	EOR (d) 2 * 5	EOR (d,s,y) 2 * 7	MVW s,y,c 3 * 7	SON d,x 2 4	LSR d,x 2 6	EOR (d,y) 2 * 6	CLI i 1 2	EOR s,y 3 4	PHY s 1 * 3	TCD i 1 * 2	JMP s,l 4 * 4	EOR s,x 3 4	LSR s,x 3 7	EOR s,x 4 * 5	
6	RTS r 1 8	ADC (d,x) 2 8	PER s 3 * 6	ADC d,s 2 * 4	STZ d 2 * 3	ADC d 2 3	ROR d 2 5	ADC (d) 2 * 6	PLA s 1 4	ADC s 2 2	ROR A 1 2	RTL s 1 * 6	JMP (s) 3 5	ADC s 3 4	ROR s 3 6	ADC s 4 * 5	
7	BVS r 2 2	ADC (d,y) 2 5	ADC (d) 2 * 5	ADC (d,s,y) 2 * 7	STZ d,x 2 * 4	ADC d,x 2 4	ROR d,x 2 6	ADC (d,y) 2 * 6	SEI i 1 2	ADC s,y 3 4	PLY s 1 * 4	TDC i 1 * 2	JMP (s,x) 3 * 6	ADC s,x 3 4	ROR s,x 3 7	ADC s,x 4 * 5	
8	BRA r 2 * 2	STA (d,x) 2 8	BRL r,l 3 * 3	STA d,s 2 * 4	STY d 2 3	STA d 2 3	STX d 2 3	STA (d) 2 * 6	DEY i 1 2	BIT s 2 * 2	TXA i 1 2	PHB s 1 * 3	STY s 3 4	STA s 3 4	STX s 3 4	STA s 4 * 5	
9	BCC r 2 2	STA (d,y) 2 8	STA (d) 2 * 5	STA (d,s,y) 2 * 7	STY d,x 2 4	STA d,x 2 4	STX d,y 2 4	STA (d,y) 2 * 6	TYA i 1 2	STA s,y 3 5	TXB i 1 2	TXY i 1 * 2	STZ s 3 4	STA s,x 3 5	STZ s,x 3 5	STA s,x 4 * 5	
A	LDY s 2 2	LDA (d,x) 2 8	LDX s 2 2	LDA d,s 2 * 4	LDY d 2 3	LDA d 2 3	LDX d 2 3	LDA (d) 2 * 6	TAY i 1 2	LDA s 2 2	TAX i 2 2	PLB s 1 * 4	LDY s 3 4	LDA s 3 4	LDX s 3 4	LDA s 4 * 5	
B	BCS r 2 2	LDA (d,y) 2 8	LDA (d) 2 * 5	LDA (d,s,y) 2 * 7	LDY d,x 2 4	LDA d,x 2 4	LDX d,y 2 4	LDA (d,y) 2 * 6	CLV i 1 2	LDA s,y 3 4	TSX i 1 2	TYX i 1 * 2	LDY s,x 3 4	LDA s,x 3 4	LDX s,y 3 4	LDA s,x 4 * 5	
C	CPY s 2 2	CMP (d,x) 2 8	REP s 2 * 3	CMP d,s 2 * 4	CPY d 2 3	CMP d 2 3	DEC d 2 5	CMP (d) 2 * 6	INY i 1 2	CMP s 2 2	DEY i 1 2	WAI i 1 * 3	CPY s 3 4	CMP s 3 4	DEC s 3 6	CMP s 4 * 5	
D	UNE r 2 2	CMP (d,y) 2 8	CMP (d) 2 * 5	CMP (d,s,y) 2 * 7	PEI s 2 * 6	CMP d,x 2 4	DEC d,x 2 6	CMP (d,y) 2 * 6	CLD i 1 2	CMP s,y 3 4	PHX s 1 * 3	STP i 1 * 3	JML (s) 3 * 6	CMP s,x 3 4	DEC s,x 3 7	CMP s,x 4 * 5	
E	CPX s 2 2	SBC (d,x) 2 8	SEP s 2 * 3	SBC d,s 2 * 4	CPX d 2 3	SBC d 2 3	INC d 2 5	SBC (d) 2 * 6	INX i 1 2	SBC s 2 2	NOP i 1 2	XBA i 1 * 3	CPX s 3 4	SBC s 3 4	INC s 3 6	SBC s 4 * 5	
F	REQ r 2 2	SBC (d,y) 2 8	SBC (d) 2 * 5	SBC (d,s,y) 2 * 7	PEA s 3 * 5	SBC d,x 2 4	INC d,x 2 6	SBC (d,y) 2 * 6	SED i 1 2	SBC s,y 3 4	PLX s 1 * 4	KCE i 1 * 2	JSR (s,x) 3 * 6	SBC s,x 3 4	INC s,x 3 7	SBC s,x 4 * 5	

symbol	addressing mode	symbol	addressing mode
#	immediate	[d]	direct indirect long
A	accumulator	[d],y	direct indirect long indexed
r	program counter relative	s	absolute
s	processor's counter relative long	s,x	absolute indexed (with x)
i	implied	s,y	absolute indexed (with y)
s	stack	al	absolute long
d	direct	al,x	absolute long indexed
d,x	direct indexed (with x)	d,s	stack relative
d,y	direct indexed (with y)	(d,s),y	stack relative indirect indexed
(d)	direct indirect	(al)	absolute indirect
(d,x)	direct indexed indirect	(s,x)	absolute indexed indirect
(d,y)	direct indirect indexed	s,y,c	block move

Op Code Matrix Legend

INSTRUCTION MNEMONIC	<ul style="list-style-type: none"> * = New W65C816/802 Opcodes • = New W65C02 Opcodes Blank = NMOS 6502 Opcodes 	ADDRESSING MODE
BASE NO. BYTES		BASE NO. CYCLES

Table 6-3 Opcode Matrix

MSD	LSD																MSD
	0	1	2	3	4	5	6	7	8	9	A	B	C	D	E	F	
0	BRK s 2 8	ORA (d,x) 2 5	COP s 2*8	ORA (d,s) 2*4	TSB d 2*5	ORA d 2 3	ASL d 2 5	ORA [d] 2*6	PHP s 1 3	ORA # 2 2	ASL A 1 2	PHD s 1*4	TSB a 3*5	ORA a 3 4	ASL a 3 6	ORA al 4*5	
1	BPL r 2 2	ORA (d,y) 2 5	ORA [d] 2*5	ORA (d,s,y) 2*7	TRB d 2*5	ORA d,x 2 4	ASL d,x 2 6	ORA [d,y] 2*6	CLC i 1 2	ORA a,y 3 4	INC A 1*2	TCS i 1*2	TRB a 3*6	ORA a,x 3 4	ASL a,x 3 7	ORA al,x 4*5	
2	JSR a 3 8	AND (d,x) 2 6	JSL al 4*8	AND (d,s) 2*4	BIT d 2 3	AND d 2 3	ROL d 2 5	AND [d] 2*6	PLP s 1 4	AND # 2 2	ROL A 1 2	PLD s 1*5	BIT a 3 4	AND a 3 4	ROL a 3 6	AND al 4*5	
3	BMI r 2 2	AND (d,y) 2 5	AND (d) 2*5	AND (d,s,y) 2*7	BIT d,x 2*4	AND d,x 2 4	ROL d,x 2 6	AND [d,y] 2*6	SEC r 1 2	AND a,y 3 4	DEC A 1*2	TSC i 1*2	BIT a,x 3*4	AND a,x 3 4	ROL a,x 3 7	AND al,x 4*5	
4	RTI s 1 7	EOR (d,x) 2 6	WDM 2*2	EOR (d,s) 2*4	MVP xyc 3*7	EOR d 2 3	LSR d 2 5	EOR [d] 2*6	PHA s 1 3	EOR # 2 2	LSR A 1 2	PHK s 1*3	JMP a 3 3	EOR a 3 4	LSR a 3 6	EOR al 4*5	
5	BVC r 2 2	EOR (d,y) 2 5	EOR (d) 2*5	EOR (d,s,y) 2*7	MVN xyc 3*7	EOR d,x 2 4	LSR d,x 2 6	EOR [d,y] 2*6	CLI i 1 2	EOR a,y 3 4	PHY s 1*3	TCD i 1*2	JMP al 4*4	EOR a,x 3 4	LSR a,x 3 7	EOR al,x 4*5	
6	RTS s 1 6	ADC (d,x) 2 5	PER s 3*6	ADC (d,s) 2*4	STZ d 2*3	ADC d 2 3	ROR d 2 5	ADC [d] 2*6	PLA s 1 4	ADC # 2 2	ROR A 1 2	RTL s 1*6	JMP (a) 3 5	ADC a 3 4	ROR a 3 6	ADC al 4*5	
7	BVS r 2 2	ADC (d,y) 2 5	ADC (d) 2*5	ADC (d,s,y) 2*7	STZ d,x 2*4	ADC d,x 2 4	ROR d,x 2 6	ADC [d,y] 2*6	SEI i 1 2	ADC a,y 3 4	PLY s 1*4	TDC i 1*2	JMP (a,x) 3*6	ADC a,x 3 4	ROR a,x 3 7	ADC al,x 4*5	
8	BRA r 2*2	STA (d,x) 2 6	BRL r/l 3*3	STA (d,s) 2*4	STY d 2 3	STA d 2 3	STX d 2 3	STA [d] 2*6	DEY i 1 2	BIT # 2*2	TXA i 1 2	PHB s 1*3	STY a 3 4	STA a 3 4	STX a 3 4	STA al 4*5	
9	BCC r 2 2	STA (d,y) 2 6	STA (d) 2*5	STA (d,s,y) 2*7	STY d,x 2 4	STA d,x 2 4	STX d,y 2 4	STA [d,y] 2*6	TYA i 1 2	STA a,y 3 5	TXS i 1 2	TXY i 1*2	STZ a 3*4	STA a,x 3 5	STZ a,x 3*5	STA al,x 4*5	
A	LDY # 2 2	LDA (d,x) 2 6	LDX # 2 2	LDA (d,s) 2*4	LOY d 2 3	LDA d 2 3	LDX d 2 3	LDA [d] 2*6	TAY i 1 2	LDA # 2 2	TAX i 1 2	PLB s 1*4	LDY a 3 4	LDA a 3 4	LDX a 3 4	LDA al 4*5	
B	BCS r 2 2	LDA (d,y) 2 5	LDA (d) 2*5	LDA (d,s,y) 2*7	LDY d,x 2 4	LDA d,x 2 4	LDX d,y 2 4	LDA [d,y] 2*6	CLV i 1 2	LDA a,y 3 4	TSX i 1 2	TYX i 1*2	LDY a,x 3 4	LDA a,x 3 4	LDX a,y 3 4	LDA al,x 4*5	
C	CPY # 2 2	CMP (d,x) 2 6	REP # 2*3	CMP (d,s) 2*4	CPY d 2 3	CMP d 2 3	DEC d 2 5	CMP [d] 2*6	INY i 1 2	CMP # 2 2	DEX i 1 2	WAI i 1*3	CPY a 3 4	CMP a 3 4	DEC a 3 6	CMP al 4*5	
D	LINE r 2 2	CMP (d,y) 2 5	CMP (d) 2*5	CMP (d,s,y) 2*7	PEI s 2*6	CMP d,x 2 4	DEC d,x 2 6	CMP [d,y] 2*6	CLD i 1 2	CMP a,y 3 4	PHX s 1*3	STP i 1*3	JML (a) 3*6	CMP a,x 3 4	DEC a,x 3 7	CMP al,x 4*5	
E	CPX # 2 2	SBC (d,x) 2 6	SEP # 2*3	SBC (d,s) 2*4	CPX d 2 3	SBC d 2 3	INC d 2 5	SBC [d] 2*6	INX i 1 2	SBC # 2 2	NOP i 1 2	XBA i 1*3	CPX a 3 4	SBC a 3 4	INC a 3 6	SBC al 4*5	
F	SEC r 2 2	SBC (d,y) 2 5	SBC (d) 2*5	SBC (d,s,y) 2*7	PEA s 3*5	SBC d,x 2 4	INC d,x 2 6	SBC [d,y] 2*6	SED i 1 2	SBC a,y 3 4	PLX s 1*4	XCE i 1*2	JSR (a,x) 3*6	SBC a,x 3 4	INC a,x 3 7	SBC al,x 4*5	
	0	1	2	3	4	5	6	7	8	9	A	B	C	D	E	F	

symbol	addressing mode	symbol	addressing mode
#	immediate	[d]	direct indirect long
A	accumulator	[d,y]	direct indirect long indexed
r	program counter relative	a	absolute
rl	program counter relative long	a,x	absolute indexed (with x)
i	implied	a,y	absolute indexed (with y)
s	stack	al	absolute long
d	direct	al,x	absolute long indexed
d,x	direct indexed (with x)	d,s	stack relative
d,y	direct indexed (with y)	(d,s,y)	stack relative indirect indexed
(d)	direct indirect	(a)	absolute indirect
(d,x)	direct indexed indirect	(a,x)	absolute indexed indirect
(d,y)	direct indirect indexed	xyz	block move

Op Code Matrix Legend

INSTRUCTION MNEMONIC	★ = New W65C816/802 Opcodes ● = New W65C02 Opcodes Blank = NMOS 6502 Opcodes	ADDRESSING MODE
BASE NO. BYTES		BASE NO. CYCLES

Table 6-5 Instruction Operation

ADDRESS MODE	CYCLE	(14)		(14)		ADDRESS BUS	DATA BUS	R/W
		\overline{VP}	\overline{ML}	VDA	VPA			
1. Immediate-# (LDY, CPY, CPX, LDX, ORA, AND, EOR, ADC, BIT, LDA, CMP, SBC, REP, SEP) (14 OpCodes) (2, 3 and bytes) (2, 3 and 5 cycles)	1.	1	1	1	1	PBR, PC	OpCode	1
	2.	1	1	0	1	PBR, PC+1	ID0	1
	(1) 2a.	1	1	0	1	PBR, PC+2-4	ID1-3	1
2a. Absolute-a (BIT, STY, STZ, LDY, CPY, CPX, STX, LDX, ORA, AND, EOR, ADC, STA, LDA, CMP, SBC) (18 OpCodes) (3 bytes) (4, 5 and 7 cycles)	1.	1	1	1	1	PBR, PC	OpCode	1
	2.	1	1	0	1	PBR, PC+1	AAL	1
	3.	1	1	0	1	PBR, PC+2	AAH	1
	4.	1	1	1	0	DBR, AA	Byte 0	1/0
(1) 4a.	1	1	1	0	DBR, AA+1-3	Bytes 1-3	1/0	
2b. Absolute-(R-M-W)-a (ASL, ROL, LSR, ROR, DEC, INC, TSB, TRB) (6 OpCodes) (3 bytes) (6 for 8-bit data, 8 for 16-bit data, 12 for 32-bit data)	1.	1	1	1	1	PBR, PC	OpCode	1
	2.	1	1	0	1	PBR, PC+1	AAL	1
	3.	1	1	0	1	PBR, PC+2	AAH	1
	4.	1	0	1	0	DBR, AA	Byte 0	1
	(1) 4a.	1	0	1	0	DBR, AA+-3	Bytes 1-3	1
	(3) 5.	1	0	0	0	DBR, AA+1 or 3	IO	1
(1) 6a.	1	0	1	0	DBR, AA+3-1	Bytes 3-1	0	
6.	1	0	1	0	DBR, AA	Byte 0	0	
2c. Absolute (JUMP)-a (JMP) (4C) (1 OpCode) (3 bytes) (3 cycles)	1.	1	1	1	1	PBR, PC	OpCode	1
	2.	1	1	0	1	PBR, PC+1	New PCL	1
	3.	1	1	0	1	PBR, PC+2	New PCH	1
	1.	1	1	1	1	PBR, NEW PC	New OpCode	1
2d. Absolute (Jump to subroutine)-a (JSR) (1 OpCode) (3 bytes) (6 cycles) (different order from N6502)	1.	1	1	1	1	PBR, PC	OpCode	1
	2.	1	1	0	1	PBR, PC+1	New PCL	1
	3.	1	1	0	1	PBR, PC+2	New PCH	1
	4.	1	1	0	0	PBR, PC+2	IO	1
	5.	1	1	1	0	0, S	PCH	0
	6.	1	1	1	0	0, S-1	PCL	0
1.	1	1	1	1	PBR, NEW PC	New OpCode	1	
*3a. Absolute Long-al (ORA, AND, EOR, ADC, STA, LDA, CMP, SBC) (8 OpCodes) (4 bytes) (5, 6 and 8 cycles)	1.	1	1	1	1	PBR, PC	OpCode	1
	2.	1	1	0	1	PBR, PC+1	AAL	1
	3.	1	1	0	1	PBR, PC+2	AAH	1
	4.	1	1	0	1	PBR, PC+3	AAB	1
	5.	1	1	1	0	AAB, AA	Byte 0	1/0
(1) 5a.	1	1	1	0	AAB, AA+1	Bytes 1-3	1/0	
*3b. Absolute Long (JUMP)-al (JMP) (1 OpCode) (4 bytes) (4 cycles)	1.	1	1	1	1	PBR, PC	OpCode	1
	2.	1	1	0	1	PBR, PC+1	New PCL	1
	3.	1	1	0	1	PBR, PC+2	New PCH	1
	4.	1	1	0	1	PBR, PC+3	New BR	1
1.	1	1	1	1	NEW PBR, PC	OpCode	1	

ADDRESS MODE	CYCLE	\overline{VP}	\overline{ML}	VDA	VPA	ADDRESS BUS	DATA BUS	R/ \overline{W}	
*3c. Absolute Long (JUMP to Subroutine Long)-al (JSL) (1 OpCode) (4 bytes) (7 cycles)	1.	1	1	1	1	PBR, PC	OpCode	1	
	2.	1	1	0	1	PBR, PC+1	New PCL	1	
	3.	1	1	0	1	PBR, PC+2	New PCH	1	
	4.	1	1	1	0	0, S	PBR	0	
	5.	1	1	0	0	0, S	IO	1	
	6.	1	1	0	1	PBR, PC+3	New PBR	1	
	7.	1	1	1	0	0, S-1	PCH	0	
	8.	1	1	1	0	0, S-2	PCL	0	
4a. Direct-d (BIT, STZ, STY, LDY, CPY, CPX, STX, LDX, ORA, AND, EOR, ADC, STA, LDA, CMP, SBC) (18 OpCodes) (2 bytes) (3, 4, 5 and 7 cycles)	1.	1	1	1	1	NEW PBR, PC	New OpCode	1	
	2.	1	1	1	1	PBR, PC	OpCode	1	
	(2) 2a.	1	1	0	0	PBR, PC+1	DO	1	
	3.	1	1	1	0	0, D+DO	Byte 0	1/0	
(1) 3a.	1	1	1	0	0, D+DO+1-3	Bytes 1-3	1/0		
4b. Direct (R-M-W)-d (ASL, ROL, LSR, ROR, DEC, INC, TSB, TRB) (6 OpCodes) (2 bytes) (5, 6, 7, 8, 11 and 12 cycles)	1.	1	1	1	1	PBR, PC	OpCode	1	
	2.	1	1	0	1	PBR, PC+1	DO	1	
	(2) 2a.	1	1	0	0	PBR, PC+1	IO	1	
	3.	1	0	1	0	0, D+DO	Byte 0	1	
	(1) 3a.	1	0	1	0	0, D+DO+1-3	Bytes 1-3	1	
	(3) 4.	1	0	0	0	0, D+DO+1 or 3	IO	1	
(1) 5a.	1	0	1	0	0, D+DO+3-1	Bytes 3-1	0		
5.	1	0	1	0	0, D+DO	Byte 0	0		
5. Accumulator-A (ASL, INC, ROL, DEC, LSR, ROR) (6 OpCodes) (1 byte) (2 cycles)	1.	1	1	1	1	PBR, PC	OpCode	1	
	2.	1	1	0	0	PBR, PC+1	IO	1	
6a. Implied i (DEY, INY, INX, DEX, NOP, XCE, TYA, TAY, TXA, TXS, TAX, TSX, TCS, TSC, TCD, TDC, TXY, TYX, CLC, SEC, CLI, SEI, CLV, CLD, SED) (25 OpCodes) (1 byte) (2 cycles)	1.	1	1	1	1	PBR, PC	OpCode	1	
	2.	1	1	0	0	PBR, PC+1	IO	1	
*6b. Implied i (XBA) (1 OpCode) (1 byte) (3 cycles)	1.	1	1	1	1	PBR, PC	OpCode	1	
	2.	1	1	0	0	PBR, PC+1	IO	1	
	3.	1	1	0	0	PBR, PC+1	IO	1	
#6c. Wait-for-Interrupt (WAI) (1 OpCode) (1 byte) (3 cycles)						RDY			
	1.	1	1	1	1	1	PBR, PC	OpCode	1
	(9) 2.	1	1	0	0	1	PBR, PC+1	IO	1
	3.	1	1	0	0	0	PBR, PC+1	IO	1
(3 cycles) \overline{IRQ} , \overline{NMI}	1.	1	1	1	1	1	PBR, PC+1	\overline{IRQ} (BRK)	1

ADDRESS MODE	CYCLE	\overline{VP}	\overline{ML}	VDA	VPA	ADDRESS BUS	DATA BUS	R/ \overline{W}
#6d. Stop-the-Clock (STP)	1.	1	1	1	1	1 PBR, PC	OpCode	1
(1 OpCode)	2.	1	1	0	0	1 PBR, PC+1	IO	1
(1 byte) RES-=1	3.	1	1	0	0	1 PBR, PC+1	IO	1
(3 cycles) RES-=0	1c.	1	1	0	0	1 PBR, PC+1	RES (BRK)	1
RES-=0	1b.	1	1	0	0	1 PBR, PC+1	RES (BRK)	1
RES-=1	1a.	1	1	0	0	1 PBR, PC+1	RES (BRK)	1
(See 21a. Stack Hardware Interrupt)	1.	1	1	1	1	1 PBR, PC+1	BEGIN	1
7. Direct Indirect	1.	1	1	1	1	PBR, PC	OpCode	1
Indexed-(d), y	2.	1	1	0	1	PBR, PC+1	DO	1
(ORA, AND, EOR, ADC, STA, LDA, CMP, SBC)	(2) 2a.	1	1	0	0	PBR, PC+1	IO	1
(8 OpCodes)	3.	1	1	1	0	0, D+DO	AAL	1
(2 bytes)	4.	1	1	1	0	0, D+DO+1	AAH	1
(5, 6, 7, 8, 9 and 10 cycles)	(4) 4a.	1	1	0	0	DBR, AAJ, AAL+YL	IO	1
	5.	1	1	1	0	DBR, AA+Y	Byte 0	1/0
	(1) 5a.	1	1	1	0	DBR, AA+Y+1-3	Bytes1-3	1/0
8. Direct Indirect	1.	1	1	1	1	PBR, PC	OpCode	1
Indexed Long-[d], y	2.	1	1	0	1	PBR, PC+1	DO	1
(ORA, AND, EOR, ADC, STA, LDA, CMP, SBC)	(2) 2a.	1	1	0	0	PBR, PC+1	IO	1
(8 OpCodes)	3.	1	1	1	0	0, D+DO	AAL	1
(2 bytes)	4.	1	1	1	0	0, D+DO+1	AAH	1
(6, 7, 8, 9 and 10 cycles)	(17) 5a.	1	1	0	0	0, 0+DO+2	IO	1
	6.	1	1	1	0	AAB, AA+Y	Byte 0	1/0
	(1) 6a.	1	1	1	0	AAB, AA+Y+1-3	Bytes1-3	1/0
9. Direct Indexed	1.	1	1	1	1	PBR, PC	OpCode	1
Indirect-(d, x)	2.	1	1	0	1	PBR, PC+1	DO	1
(ORA, AND, EOR, ADC, STA, LDA, CMP, SBC)	(2) 2a.	1	1	0	0	PBR, PC+1	IO	1
(8 OpCodes)	3.	1	1	0	0	PBR, PC+1	IO	1
(2 bytes)	4.	1	1	1	0	0, D+DO+X	AAL	1
(6, 7, 8, 9 and 10 cycles)	5.	1	1	1	0	0, D+DO+X+1	AAH	1
	6.	1	1	1	0	DBR, AA	Byte 0	1/0
	(1) 6a.	1	1	1	0	DBR, AA+1-3	Bytes1-3	1/0
10a. Direct, X-d, x	1.	1	1	1	1	PBR, PC	OpCode	1
(BIT, STZ, STY, LDY, ORA, AND, EOR, ADC, STA, LDA, CMP, SBC)	(2) 2a.	1	1	0	0	PBR, PC+1	IO	1
(11 OpCodes)	3.	1	1	0	0	PBR, PC+1	IO	1
(2 bytes)	4.	1	1	1	0	0, D+DO+X	Byte 0	1/0
(4, 5, 6, 7 and 8 cycles)	(1) 4a.	1	1	1	0	0, D+DO+X+1	Bytes1-3	1/0
10b. Direct, X(R-M-W)-d, x	1.	1	1	1	1	PBR, PC	OpCode	1
(ASL, ROL, LSR, ROR, DEC, INC)	(2) 2a.	1	1	0	0	PBR, PC+1	IO	1
(6 OpCodes)	3.	1	1	0	0	PBR, PC+1	IO	1
(2 bytes)	4.	1	0	1	0	0, D+DO+X	Byte 0	1
(6, 7, 8, 9, 12 and 13 cycles)	(1) 4a.	1	0	1	0	0, D+DO+X+1	Bytes1-3	1
	(3) 5.	1	0	0	0	0, D+DO+X+1	IO	1
	(1) 6a.	1	0	1	0	0, D+DO+X+1	Bytes 3-1	0
	6.	1	0	1	0	0, D+DO+X	Byte 0	0

ADDRESS MODE	CYCLE	\overline{VP}	\overline{ML}	VDA	VPA	ADDRESS BUS	DATA BUS	R/ \overline{W}	
11. Direct, Y-d, y (STX, LDX) (2 OpCodes) (2 bytes) (4, 5, 6, 7 and 8 cycles)	1.	1	1	1	1	PBR, PC	OpCode	1	
	2.	1	1	0	1	PBR, PC+1	DO	1	
	(2) 2a.	1	1	0	0	PBR, PC+1	IO	1	
	3.	1	1	0	0	PBR, PC+1	IO	1	
	4.	1	1	1	0	0, D+DO+Y	Byte 0	1/0	
(1) 4a.	1	1	1	0	0, D+DO+Y+1-3	Bytes 1-3	1/0		
	12a. Absolute, X-a, x (BIT, LDY, STZ, ORA, AND, EOR, ADC, STA, LDA, CMP, SBC) (11 OpCodes) (3 bytes) (4, 5, 6, 7 and 8 cycles)	1.	1	1	1	1	PBR, PC	OpCode	1
	2.	1	1	0	1	PBR, PC+1	AAL	1	
	3.	1	1	0	1	PBR, PC+2	AAH	1	
	(4) 3a.	1	1	0	0	DBR, AAH, AAL+XL	IO	1	
4.	1	1	1	0	DBR, AA+X	Byte 0	1/0		
(1) 4a.	1	1	1	0	DBR, AA+X+1-3	Bytes 1-3	1/0		
12b. Absolute, X(R-M-W)-a, x (ASL, ROL, LSR, ROR, DEC, INC) (6 OpCodes) (3 bytes) (7, 9 and 13 cycles)	1.	1	1	1	1	PBR, PC	OpCode	1	
	2.	1	1	0	1	PBR, PC+1	AAL	1	
	3.	1	1	0	1	PBR, PC+2	AAH	1	
	4.	1	1	0	0	DBR, AAH, AAL+XL	IO	1	
	5.	1	0	1	0	DBR, AA+X	Byte 0	1	
	(1) 5a.	1	0	1	0	DBR, AA+X+1-3	Bytes 1-3	1	
	(3) 6.	1	0	0	0	DBR, AA+X+1or3	IO	1	
(1) 7a.	1	0	1	0	DBR, AA+X+3-1	Bytes 3-1	0		
	7.	1	0	1	0	DBR, AA+X	Byte 0	0	
	*13. Absolute Long, X-al, x (ORA, AND, EOR, ADC, STA, LDA, CMP, SBC) (8 OpCodes) (4 bytes) (5, 6, 7 and 8 cycles)	1.	1	1	1	1	PBR, PC	OpCode	1
	2.	1	1	0	1	PBR, PC+1	AAL	1	
	3.	1	1	0	1	PBR, PC+2	AAH	1	
4.	1	1	0	1	PBR, PC+3	AAB	1		
(17) 4a.	1	1	0	0	PBR, PC+3	IO	1		
5.	1	1	1	0	AAB, AA+X	Byte 0	1/0		
(1) 5a.	1	1	1	0	AAB, AA+X+1-3	Bytes 1-3	1/0		
14. Absolute, Y-a, y (LDX, ORA, AND, EOR, ADC, STA, LDA, CMP, SBC) (9 OpCodes) (3 bytes) (4, 5, 6, 7 and 8 cycles)	1.	1	1	1	1	PBR, PC	OpCode	1	
	2.	1	1	0	1	PBR, PC+1	AAL	1	
	3.	1	1	0	1	PBR, PC+2	AAH	1	
	(4) 3a.	1	1	0	0	DBR, AAH, AAL+Y	IO	1	
	4.	1	1	1	0	DBR, AA+Y	Byte 0	1/0	
(1) 4a.	1	1	1	0	DBR, AA+Y+1-3	Bytes 1-3	1/0		
15. Relative-r (BPL, BMI, BVC, BVS, BCC, BCS, BNE, BEQ, BRA) (9 OpCodes) (2 bytes) (2, 3 and 4 cycles)	1.	1	1	1	1	PBR, PC	OpCode	1	
	2.	1	1	0	1	PBR, PC+1	OFF	1	
	(5) 2a.	1	1	0	0	PBR, PC+1	IO	1	
	(6) 2b.	1	1	0	0	PBR, PC+1	IO	1	
1.	1	1	1	1	PBR, PC+Offset	OpCode	1		
*16. Relative Long-rl (BRL) (1 OpCode) (3 bytes) (4 cycles)	1.	1	1	1	1	PBR, PC	OpCode	1	
	2.	1	1	0	1	PBR, PC+1	OFF Low	1	
	3.	1	1	0	1	PBR, PC+2	OFF High	1	
	4.	1	1	0	0	PBR, PC+2	IO	1	
	1.	1	1	1	1	PBR, PC+Offset	OpCode	1	
17a. Absolute Indirect-(a) (JMP) (1 OpCode) (3 bytes) (5 cycles)	1.	1	1	1	1	PBR, PC	OpCode	1	
	2.	1	1	0	1	PBR, PC+1	AAL	1	
	3.	1	1	0	1	PBR, PC+2	AAH	1	
	4.	1	1	1	0	0, AA	New PCL	1	
	5.	1	1	1	0	0, AA+1	New PCH	1	
	1.	1	1	1	1	PBR, NEW PC	OpCode	1	

ADDRESS MODE	CYCLE	\overline{VP}	\overline{ML}	VDA	VPA	ADDRESS BUS	DATA BUS	R/W
*17b. Absolute Indirect-(a) (JML) (1 OpCode) (3 bytes) (6 cycles)	1.	1	1	1	1	PBR, PC	OpCode	1
	2.	1	1	0	1	PBR, PC+1	AAL	1
	3.	1	1	0	1	PBR, PC+2	AAH	1
	4.	1	1	1	0	0, AA	New PCL	1
	5.	1	1	1	0	0, AA+1	New PCH	1
	6.	1	1	1	0	0, AA+2	New PBR	1
#18. Direct Indirect-(d) (ORA, AND, EOR, ADC, STA, LDA, CMP, SBC) (8 OpCodes) (2 bytes) (5, 6, 7, 8 and 9 cycles)	1.	1	1	1	1	NEW PBR, PC	OpCode	1
	2.	1	1	0	1	PBR, PC+1	OpCode	1
	(2) 2a.	1	1	0	0	PBR, PC+1	DO	1
	3.	1	1	1	0	0, D+DO	IO	1
	4.	1	1	1	0	0, D+DO+1	AAL	1
	5.	1	1	1	0	DBR, AA	Byte 0	1/0
*19. Direct Indirect Long-[d] (ORA, AND, EOR, ADC STA, LDA, CMP, SBC) (8 OpCodes) (2 bytes) (6, 7, 8, 9 and 10 cycles)	(1) 5a.	1	1	1	0	PBR, AA+1-3	Bytes 1-3	1/0
	1.	1	1	1	1	PBR, PC	OpCode	1
	2.	1	1	0	1	PBR, PC+1	DO	1
	(2) 2a.	1	1	0	0	PBR, PC+1	IO	1
	3.	1	1	1	0	0, D+DO	AAL	1
	4.	1	1	1	0	0, D+DD+1	AAH	1
20a. Absolute Indexed Indirect- (a, x) (JMP) (1 OpCode) (3 bytes) (6 cycles)	5.	1	1	1	0	0, D+DO+2	AAB	1
	(1) 6a.	1	1	1	0	AAB, AA	Byte 0	1/0
	1.	1	1	1	0	AAB, AA+1-3	Bytes 1-3	1/0
	1.	1	1	1	1	PBR, PC	OpCode	1
	2.	1	1	0	1	PBR, PC+1	AAL	1
	3.	1	1	0	1	PBR, PC+2	AAH	1
*20b. Absolute Indexed Indirect- (a, x) (JSR) (1 OpCode) (3 bytes) (8 cycles)	4.	1	1	0	0	PBR, PC+2	IO	1
	5.	1	1	0	1	PBR, AA+X	New PCL	1
	6.	1	1	0	1	PBR, AA+X+1	New PCH	1
	1.	1	1	1	1	PBR, NEW PC	OpCode	1
	2.	1	1	0	1	PBR, PC+1	AAL	1
	3.	1	1	1	0	0, S	PCH	0
	4.	1	1	1	0	0, S-1	PCL	0
	5.	1	1	0	1	PBR, PC+2	AAH	1
21a. Stack (Hardware Interrupts)-s (IRQ, NMI, ABORT, RES) (4 hardware interrupts) (0 bytes) (7 and 8 cycles)	6.	1	1	0	0	PBR, PC+2	IO	1
	7.	1	1	0	1	PBR, AA+X	New PCL	1
	8.	1	1	0	1	PBR, AA+X+1	New PCH	1
	1.	1	1	1	1	PBR, NEW PC	New OpCode	1
	(3) 2.	1	1	0	0	PBR, PC	IO	1
	(7) 3.	1	1	1	0	0, S	PBR	0
	(10) 4.	1	1	1	0	0, S-1	PCH	0
	(10) 5.	1	1	1	0	0, S-2	PCL	0
	(10) (11) 6.	1	1	1	0	0, S-3	P	0
	7.	0	1	1	0	0, VA	AAVL	1
8.	0	1	1	0	0, VA+1	AAVH	1	
1.	1	1	1	1	0, AAV	New OpCode	1	

ADDRESS MODE	CYCLE	\overline{VP}	\overline{ML}	VDA	VPA	ADDRESS BUS	DATA BUS	R/ \overline{W}
21b. Stack (Software Interrupts)-s (BRK, COP) (2 OpCodes) (2 bytes) (7 and 8 cycles)	(16) 1.	1	1	1	1	PBR, PC	OpCode	1
	(16) (3) 2.	1	1	0	1	PBR, PC+1	Signature	1
	(7) 3.	1	1	1	0	O, S	PBR	0
	4.	1	1	1	0	O, S-1	PCH	0
	5.	1	1	1	0	O, S-2	PCL	0
	6.	1	1	1	0	O, S-3 (16)	P	0
	7.	0	1	1	0	O, VA	AAVL	1
	8.	0	1	1	0	O, VA+1	AAVH	1
	1.	1	1	1	1	O, AAV	New OpCode	1
	21c. Stack (Return from Interrupt)-s (RTI) (1 Op Code) (1 byte) (6 and 7 cycles) (different order from N6502)	1.	1	1	1	1	PBR, PC	OpCode
2.		1	1	0	0	PBR, PC+1	IO	1
(3) 3.		1	1	0	0	PBR, PC+1	IO	1
4.		1	1	1	0	O, S+1	P	1
5.		1	1	1	0	O, S+2	PCL	1
6.		1	1	1	0	O, S+3	PCH	1
(7) 7.		1	1	1	0	O, S+4	PBR	1
21d. Stack (Return from Subroutine)-s (RTS) (1 Op Code) (1 byte) (6 cycles)	1.	1	1	1	1	PBR, PC	New OpCode	1
	2.	1	1	0	0	PBR, PC+1	OpCode	1
	3.	1	1	0	0	PBR, PC+1	IO	1
	4.	1	1	1	0	O, S+1	IO	1
	5.	1	1	1	0	O, S+2	PCL	1
	6.	1	1	0	0	NEW PC-1	PCH	1
*21e. Stack (Return from Subroutine Long)-s (RTL) (1 Op Code) (1 byte) (6 cycles)	1.	1	1	1	1	PBR, PC	IO	1
	2.	1	1	0	0	PBR, PC+1	OpCode	1
	3.	1	1	0	0	PBR, PC+1	IO	1
	4.	1	1	1	0	O, S+1	IO	1
	5.	1	1	1	0	O, S+2	New PCL	1
	6.	1	1	1	0	O, S+3	New PCH	1
21f. Stack (Push)-s (PHP, PHA, PHY, PHX, PHD, PHK, PHB) (7 Op Codes) (1 byte) (3, 4, and 6 cycles)	1.	1	1	1	1	NEW PBR, PC	New PBR	1
	2.	1	1	1	1	PBR/PC	New OpCode	1
	(1) (11) 3a.	1	1	1	0	PBR, PC+1	OpCode	1
21g. Stack (Pull)-s (PLP, PLA, PLY, PLX, PLD, PLB) (Different than N6502) (6 Op Codes) (1 byte) (4, 5 and 7 cycles)	3.	1	1	1	0	O, S	IO	1
	3.	1	1	1	0	O, S-1-3	Bytes3-1	1
	3.	1	1	1	0	O, S-1-3	Byte0	1
*21h. Stack (Push Effective Indirect Address)-s (PEI) (1 Op Code) (2 bytes) (6 and 7 cycles)	1.	1	1	1	1	PBR, PC	Bytes1-3	1
	2.	1	1	0	1	PBR, PC+1	OpCode	1
	(2) 2a.	1	1	0	0	PBR, PC+1	DO	1
	3.	1	1	1	0	O, D+DO	IO	1
	4.	1	1	1	0	O, D+DO+1	AAL	1
	5.	1	1	1	0	O, S-1	AAH	1
6.	1	1	1	0	O, S-1	AAH	0	
						O, S-1	AAL	0

ADDRESS MODE	CYCLE	\overline{VP}	\overline{ML}	VDA	VPA	ADDRESS BUS	DATA BUS	R/W
*21i. Stack (Push Effective Absolute Address)-s (PEA) (1 Op Code) (3 bytes) (5 cycles)	1.	1	1	1	1	PBR, PC	OpCode	1
	2.	1	1	0	1	PBR, PC+1	AAL	1
	3.	1	1	0	1	PBR, PC+2	AAH	1
	4.	1	1	1	0	O, S	AAH	0
	5.	1	1	1	0	O, S-1	AAL	0
*21j. Stack (Push Effective Program Counter Relative Address)-s (PER) (1 Op Code) (3 bytes) (6 cycles)	1.	1	1	1	1	PBR, PC	OpCode	1
	2.	1	1	0	1	PBR, PC+1	OFF Low	1
	3.	1	1	0	1	PBR, PC+2	OFF High	1
	4.	1	1	0	0	PBR, PC+2	IO	1
	5.	1	1	1	0	O, S	PCH+OFF+	0
	6.	1	1	1	0	O, S-1	Carry PCL+OFF	0
*22. Stack Relative-d,s (ORA, AND, EOR, ADL, STA, LDA, CMP, SBC) (8 Op Codes) (2 bytes) (4, 5 and 7 cycles)	1.	1	1	1	1	PBR, PC	OpCode	1
	2.	1	1	0	1	PBR, PC+1	SO	1
	3.	1	1	0	0	PBR, PC+1	IO	1
	4.	1	1	1	0	O, S+SO	Byte 0	1/0
(1) 4a.	1	1	1	0	O, S+SO+1-3	Bytes 1-3	1/0	
*23. Stack Relative Indirect Indexed-(d,s),y (ORA, AND, EOR, ADC, STA, LDA, CMP, SBC) (8 Op Codes) (2 bytes) (7, 8 and 10 cycles)	1.	1	1	1	1	PBR, PC	OpCode	1
	2.	1	1	0	1	PBR, PC+1	SO	1
	3.	1	1	0	0	PBR+PC+1	IO	1
	4.	1	1	1	0	O, S+SO	AAL	1
	5.	1	1	1	0	O, S+SO+1	AAH	1
	6.	1	1	0	0	O, S+SO+1	IO	1
	7.	1	1	1	0	DBR, AA+Y	Byte 0	1/0
(1) 7a.	1	1	1	0	DBR, AA+Y+1-3	Bytes 1-3	1/0	
*24a. Block Move Positive (forward)-xyc (MVP) (1 Op Code) (3 bytes) (5 and 7 cycles)	1.	1	1	1	1	PBR, PC	OpCode	1
	(18) 2.	1	1	0	1	PBR, PC+1	DBA	1
	(18) 3.	1	1	0	1	PBR, PC+2	SBA	1
	N-2) 4.	1	1	1	0	SBA, X	SRC Data	1
	Byte) 5.	1	1	1	0	DBA, Y	DEST Data	0
	C-2) 6.	1	1	0	0	DBA, Y	IO	1
	7.	1	1	0	0	DBA, Y	IO	1
x=Source Address y=Destination c=#of bytes to move-1(18) x,y Decrement MVP is used when the dest. start address is higher (more positive) than the source start address.	1.	1	1	1	1	PBR, PC	OpCode	1
2.	1	1	0	1	PBR, PC+1	DBA	1	
(18) 3.	1	1	0	1	PBR, PC+2	SBA	1	
N-1) 4.	1	1	1	0	SBA, X-1	SRC Data	1	
Byte) 5.	1	1	1	0	DBA, Y-1	DEST Data	0	
C-1) 6.	1	1	0	0	DBA, Y-1	IO	1	
7.	1	1	0	0	DBA, Y-1	IO	1	
FFFFF ^ Dest Start Source Start Dest End Source End 000000	1.	1	1	1	1	PBR, PC	Op Code	1
(18) 2.	1	1	0	1	PBR, PC+1	DBA	1	
(18) 3.	1	1	0	1	PBR, PC+2	SBA	1	
N Byte) 4.	1	1	1	0	SBA, X-2	SRC Data	1	
Last) 5.	1	1	1	0	DBA, Y-2	DEST Data	0	
C=0) 6.	1	1	0	0	DBA, Y-2	IO	1	
7.	1	1	0	0	DBA, Y-2	IO	1	
1.	1	1	1	1	PBR, PC+3	New OpCode	1	

ADDRESS MODE	CYCLE	\overline{VP}	\overline{ML}	VDA	VPA	ADDRESS BUS	DATA BUS	R/ \overline{W}
*24b. Block Move Negative	1	1	1	1	1	PBR, PC	OpCode	1
(backward) -xyc	(18) 2	1	1	0	1	PBR, PC+1	DBA	1
(MVN)	(18) 3	1	1	0	1	PBR, PC+2	SBA	1
(1 Op Code)	N-2 4	1	1	1	0	SBA, X	SRC Data	1
(3 bytes)	Byte 5	1	1	1	0	DBA, Y	DEST Data	0
(7 cycles)	C-2 6	1	1	0	0	DBA, Y	IO	1
	7	1	1	0	0	DBA, Y	IO	1
x=Source Address	1	1	1	1	1	PBR, PC	OpCode	1
y=Destination	2	1	1	0	1	PBR, PC+1	DBA	1
c=#of bytes to move-1	(18) 3	1	1	0	1	PBR, PC+2	SBA	1
x, y Increment	(18) 4	1	1	1	0	SBA, X+1	SRC Data	1
MVN is used when the	N-1 5	1	1	1	0	DBA, Y+1	DEST Data	0
dest. start address	Byte 6	1	1	0	0	DBA, Y+1	IO	1
is lower (more	C-1 7	1	1	0	0	DBA, Y+1	IO	1
negative) than the source	7	1	1	0	0	DBA, Y+1	IO	1
start address.	1	1	1	1	1	PBR, PC	OpCode	1
FFFFF	(18) 2	1	1	0	1	PBR, PC+1	DBA	1
Source End	(18) 3	1	1	0	1	PBR, PC+2	SBA	1
N Byte	4	1	1	1	0	SBA, X+2	SRC Data	1
Dest. End	C=0 5	1	1	1	0	DBA, Y+2	DEST Data	0
Source Start	6	1	1	0	0	DBA, Y+2	IO	1
V Dest. Start	7	1	1	0	0	DBA, Y+2	IO	1
000000	1	1	1	1	1	PBR, PC+3	New OpCode	1

- Add 1 byte (for immediate only) for 16-bit data, add 3 bytes for 32-bit data, add 1 cycle for 16-bit data and 3 cycles for 32-bit data.
- Add 1 cycle for direct register low (DL) not equal 0.
- Special case for aborting instruction. This is the last cycle which may be aborted or the Status, PBR or DBR registers will be updated.
- Add 1 cycle for indexing across page boundaries, or write, or 16-bit or 32-bit Index Registers. When 8-bit Index Registers or in the emulation mode, this cycle contains invalid addresses.
- Add 1 cycle if branch is taken.
- Add 1 cycle if branch is taken across page boundaries in 6502 emulation mode.
- Subtract 1 cycle for 6502 emulation mode.
- Add 1 cycle for REP, SEP.
- Wait at cycle 2 for 2 cycles after NMI- or IRQ- active input.
- R/W- remains high during Reset.
- BRK bit 4 equals "0" in Emulation mode.
- PHP and PLP.
- Some OpCodes shown are not on the W65C02.
- VDA and VPA are not valid outputs on the W65C02 but are valid on the W65C832. The two signals, VDA and VPA, are included to point out the upward compatibility to the W65C832. When VDA and VPA are both a one level, this is equivalent to SYNC being a one level.
- The PBR is not on the W65C02.
- Co-processors may monitor the signature byte to aid in processor to co-processor communications.
- Add 1 cycle for 32-bit Index Register mode.
- Subtract 2 bytes and 2 cycles when in W65C832 Native mode for MVN and MVP.

AAB	Absolute Address Bank	OFF	Offset
AAH	Absolute Address High	P	Status Register
AAL	Absolute Address Low	PBR	Program Bank Register
AAVH	Absolute Address Vector High	PC	Program Counter
AAVL	Absolute Address Vector Low	PCH	Program Counter High
Byte 0	Data Byte 0	PCL	Program Counter Low
Bytes 1-3	Data Bytes 1-3	R-M-W	Read-Modify-Write
C	Accumulator	S	Stack Address
D	Direct Register	SBA	Source Bank Address
DBA	Destination Bank Address	SRC	Source
DBR	Data Bank Register	SO	Stack Offset
DEST	Destination	VA	Vector Address
DO	Direct Offset	x,y	Index Register
ID0	Immediate Data Byte 0		
ID1-3	Immediate Data Bytes 1-3		
IO	Internal Operation		

* = New W65C816/802 Addressing Modes

† = New W65C02 Addressing Modes

Blank = NMOS 6502 Addressing Modes

SECTION 7

RECOMMENDED ASSEMBLER SYNTAX STANDARDS

7.1 Directives

Assembler directives are those parts of the assembly language source program which give directions to the assembler; this includes the definition of data area and constants within a program. This standard excludes any definitions of assembler directives.

7.2 Comments

An assembler should provide a way to use any line of the source program as a comment. The recommended way of doing this is to treat any blank line, or any line that starts with a semi-colon or an asterisk as a comment. Other special characters may be used as well.

7.3 The Source Line

Any line which causes the generation of a single machine language instruction should be divided into four fields: a label field, the operation code, the operand, the comment field.

7.3.1 The Label Field--The label field begins in column one of the line. A label must start with an alphabetic character, and may be followed by zero or more alphanumeric characters. An assembler may define an upper limit on the number of characters that can be in a label, so long as that upper limit is greater than or equal to six characters. An assembler may limit the alphabetic characters to upper-case characters if desired. If lower-case characters are allowed, they should be treated as identical to their upper-case equivalents. Other characters may be allowed in the label, so long as their use does not conflict with the coding of operand fields.

7.3.2 The Operation Code Field--The operation code shall consist of a three character sequence (mnemonic) from Table 6-2. It shall start no sooner than column 2 of the line, or one space after the label if a label is coded.

7.3.2.1 Many of the operation codes in Table 6-2 have duplicate mnemonics; when two or more machine language instruction have the same mnemonic, the assembler resolves the difference based on the operand.

7.3.2.2 If an assembler allows lower-case letters in labels, it must also allow lower-case letters in the mnemonic. When lower-case letters are used in the mnemonic, they shall be treated as equivalent to the upper-case counterpart. Thus, the mnemonics LDA, lDa and LdA must all be recognized, and are equivalent.

7.3.2.3 In addition to the mnemonics shown in Table 6-2, an assembler may provide the alternate mnemonics shown in Table 7-3-1.

Table 7-3-1 Alternate Mnemonics

Standard	Alias
BCC	BLT
BCS	BGE
CMP A	CMA
DEC A	DEA
INC A	INA
JSL	JSR
JML	JMP
TCD	TAD
TCS	TAS
TDC	TDA
TSC	TSA
XBA	SWA

7.3.2.4 JSL should be recognized as equivalent to JSR when it is specified with a long absolute address. JML is equivalent to JMP with long addressing forced.

7.3.3 The Operand Field--The operand field may start no sooner than one space after the operation code field. The assembler must be capable of at least twenty-four bit address calculations. The assembler should be capable of specifying addresses as labels, integer constants, and hexadecimal constants. The assembler must allow addition and subtraction in the operand field. Labels shall be recognized by the fact that they start alphabetic characters. Decimal numbers shall be recognized as containing only the decimal digits 0...9. Hexadecimal constants shall be recognized by prefixing the constant with a "\$" character, followed by zero or more of either the decimal digits or the hexadecimal digits "A"..."F". If lower-case letters are allowed in the label field, then they shall also be allowed as hexadecimal digits.

7.3.3.1 All constants, no matter what their format, shall provide at least enough precision to specify all values that can be represented by a twenty-four bit signed or unsigned integer represented in two's complement notation.

7.3.3.2 Table 7-3-2 shows the operand formats which shall be recognized by the assembler. The symbol *d* is a label or value which the assembler can recognize as being less than \$100. The symbol *a* is a label or value which the assembler can recognize as greater than \$FF but less than \$10000; the symbol *al* is a label or value that the assembler can recognize as being greater than \$FFF. The symbol EXT is a label which cannot be located by the assembler at the time the instruction is assembled. Unless instructed otherwise, an assembler shall assume that EXT labels are two bytes long. The symbols *r* and *rl* are 8 and 16 bit signed displacements calculated by the assembler.

7.3.3.3 Note that the operand does not determine whether or not immediate address loads one or two bytes, this is determined by the setting of the status register. This forces the requirement for a directive or directives that tell the assembler to generate one or two bytes of space for immediate loads. The directives provided shall allow separate settings for the accumulator and index registers.

7.3.3.4 The assembler shall use the <, >, and ^ characters after the # character in immediate address to specify which byte or bytes will be selected from the value of the operand. Any calculations in the operand must be performed before the byte selection takes place. Table 7-3-2 defines the action taken by each operand by showing the effect of the operator on an address. The column that shows a two byte immediate value show the bytes in the order in which they appear in memory. The coding of the operand is for an assembler which uses 32 bit address calculations, showing the way that the address should be reduced to a 24 bit value.

Table 7-3-2 Byte Selection Operator

Operand	One Byte Result	Two Byte Result	Four Byte Result
#\$01020304	04	03 04	01 02 03 04
#<\$01020304	04	03 04	
#>\$01020304	03	02 03	
#^\$01020304	02	01 01	

7.3.3.5 In any location in an operand where an address, or expression resulting in an address, can be coded, the assembler shall recognize the prefix characters <, |, and >, which force one byte (direct page), two byte (absolute) or three byte (long absolute) addressing. In cases where the addressing modes is not forced, the assembler shall assume that the address is two bytes unless the assembler is able to determine the type of addressing required by context, in which case that addressing mode will be used. Addresses shall be truncated without error in an addressing mode is forced which does not require the entire value of the address. For example,

LDA \$0203 LDA |\$010203

are completely equivalent. If the addressing mode is not forced, and the type of addressing cannot be determined from context, the assembler shall assume that a two byte address is to be used. If an instruction does not have a short addressing mode (as in LDA< which has no direct page indexed by Y) and a short address is used in the operand, the assembler shall automatically extend the address by padding the most significant bytes with zeroes in order to extend the address to the length needed. As with immediate address, any expression evaluation shall take place before the address is selected; thus, the address selection character is only used once, before the address of expression.

7.3.3.6 The ! (exclamation point) character should be supported as an alternative to the | (vertical bar).

7.3.3.7 A long indirect address is indicated in the operand field of an instruction field of an instruction by surrounding the direct page address where the indirect address is found by square brackets; direct page addresses which contain sixteen-bit addresses are indicated by being surrounded by parentheses.

7.3.3.8 The operands of a block move instruction are specified as source bank, destination bank-the opposite order of the object bytes generated.

7.3.4 Comment Field--The comment field may start no sooner than one space after the operation code field or operand field depending on instruction type.

SECTION 8

CAVEATS

Table 8-1 W65C816 Compatibility Issues

	W65C816/802	W65C02	NMOS 6502
1. S (Stack)	Always page 1 (E=1), 8 bits; 16 bits when (E=0)	Always page 1, 8 bits	Always page 1, 8 bits
2. X (X Index Reg)	Indexed page zero always in page 0 (E=1), Cross page (E=0)	Always page 0	Always page 0
3. Y (Y Index Reg)	Indexed page zero always in page 0 (E=1), Cross page (E=0)	Always page 0	Always page 0
4. A (Accumulator)	8 bits (M=1), 16 bits (M=0)	8 bits	8 bits
5. (Flag Reg)	N, V, and Z flags valid in decimal mode. D=0 after reset/interrupt.	N, V, and Z flags valid in dec. mode. D=0 after reset/interrupt.	N, V, and Z flags invalid in decimal mode. D=unknown after reset. D not modified after interrupt.
6. Timing			
A. ABS, X ASL, LSR, RCL, ROR With No Page Crossing	7 cycles	6 cycles	7 cycles
B. Jump Indirect Operand=XXFF	5 cycles	6 cycles	5 cycles and invalid page crossing
C. Branch Across Page	4 cycles (E=1) 3 cycles (E=0)	4 cycles	4 cycles
D. Decimal Mode	No add. cycle	Add 1 cycle	No add. cycle
7. BRK Vector	00FFFE, F (E=1) BRK bit=0 on stack if IRQ-, NMI-, ABORT-. 00FFE6, 7 (E=0) X=X on Stack always	FFFE, F BRK bit=0 on stack if IRQ-, NMI-.	FFFE, F BRK bit=0 on stack if IRQ-, NMI-.
8. Interrupt or Break Bank Address	PBR not pushed (E=1), RTI PBR not pulled (E=1), PBR pushed (E=0), RTI PBR pulled (E=0)	Not available	Not available
9. Memory Lock (ML-)	ML=0 during Read/Modify and Write cycles.	ML=0 during Modify and Write cycles.	Not available

	W65C816/802	W65C02	NMOS 6502
10. Indexed Across Page Boundary (d),y;a,x; a,y	Extra read of invalid address. (Note 1)	Extra read of last instruction fetch.	Extra read of invalid address.
11. RDY Pulled During Write Cycle	Ignored (E=1) for W65C816 only. Processor stops (E=0).	Processor stops.	Ignored.
12. WAI & STP instruct.	Available	Available	Not available
13. Unused OP Codes	One reserved OP Code specified as WDM will be used in future systems. The W65C816 performs a no-operation.	No operation.	Unknown and some "hang up" processor.
14. Bank Address Handling	PBR=00 after re-set or interrupts	Not available	Not available
15. R/W- During Read-Modify-Write Instructions	E=1, R/W-=0 during Modify and Write cycles. E=0, R/W-=0 only during Write cycle.	R/W-=0 only during Write cycle.	R/W-=0 during Modify and Write cycles.
16. Pin 7	W65C802=SYNC. W65C816=VPA	SYNC	SYNC
17. COP Instruction Signatures 00-7F defined. Signatures 80-FF reserved	Available	Not available	Not available

8.1 Stack Addressing

When in the Native mode, the Stack may use memory locations 000000 to 00FFFFFF. The effective address of Stack, Stack Relative, and Stack Relative Indirect Indexed addressing modes will always be within this range. In the Emulation mode, the Stack address range is 000100 to 0001FF. The following opcodes and addressing modes will increment or decrement beyond this range when accessing two or three bytes.

JSL; JSR(a,x); PEA, PEI, PER, PHD, PLD, RTL; d, s; (d,s), y

8.2 Direct Addressing

8.2.1 The Direct Addressing modes are often used to access memory registers and pointers. The effective address generated by Direct; Direct,X and Direct,Y addressing modes will always be in the Native mode range 000000 to 00FFFFFF. When in the Emulation mode, the direct addressing range is 000000 to 0000FF, except for [Direct] and [Direct],Y addressing modes and the PEI instruction which will increment from 0000FE or 0000FF into the Stack area.

- 8.2.2 When in the Emulation mode and DH is not equal to zero, the direct addressing range is 00DH00 to 00DHFF, except for [Direct] and [Direct],Y addressing modes and the PEI instruction which will increment from 00DHFE or 00DHFF into the next higher page.
- 8.2.3 When in the Emulation mode and DL is not equal to zero, the direct addressing range is 000000 to 00FFFF.

8.3 Absolute Indexed Addressing

The Absolute Indexed addressing modes are used to address data outside the direct addressing range. The W65C02 and W65C832 addressing range is 0000 to FFFF. Indexing from page FFX may result in a 00YY data fetch when using the W65C02 or W65C832. In contrast, indexing from page ZZFFX may result in ZZ+1,00YY when using the W65C832.

8.4 ABORT- Input

8.4.1 ABORT- should be held low for a period not to exceed one cycle. Also, if ABORT- is held low during the Abort Interrupt sequence, the Abort Interrupt will be aborted. It is not recommended to abort the Abort Interrupt. The ABORT- internal latch is cleared during the second cycle of the Abort Interrupt. Asserting the ABORT- input after the following instruction cycles will cause registers to be modified:

8.4.1.1 Read-Modify-Write: Processor status modified if ABORT- is asserted after a modify cycle.

8.4.1.2 RTI: Processor status modified if ABORT- is asserted after cycle 3.

8.4.1.3 IRQ-, NMI-, ABORT- BRK, COP: When ABORT- is asserted after cycle 2, PBR and DBR will become 00 (Emulation mode) or PBR will become 00 (Native mode).

8.4.2 The Abort- Interrupt has been designed for virtual memory systems. For this reason, asynchronous ABORT's- may cause undesirable results due to the above conditions.

8.5 VDA and VPA Valid Memory Address Output Signals

When VDA or VPA are high and during all write cycles, the Address Bus is always valid. VDA and VPA should be used to qualify all memory cycles. Note that when VDA and VPA are both low, invalid addresses may be generated. The Page and Bank addresses could also be invalid. This will be due to low byte addition only. The cycle when only low byte addition occurs is an optional cycle for instructions which read memory when the Index Register consists of 8 bits. This optional cycle becomes a standard cycle for the Store instruction, all instructions using the 16-bit Index Register mode, and the Read-Modify-Write instruction when using 8- or 16-bit Index Register modes.

8.6 Apple II, IIe, IIc and II+ Disk Systems

VDA and VPA should not be used to qualify addresses during disk operation on Apple systems. Consult your Apple representative for hardware/software configurations.

8.7 DB/BA Operation when RDY is Pulled Low

When RDY is low, the Data Bus is held in the data transfer state (i.e., PHI2 high). The Bank address external transparent latch should be latched when the PHI2 clock or RDY is low.

8.8 M/X Output

The M/X output reflects the valid of the M and X bits of the processor Status Register. The REP, SEP and PLP instructions may change the state of the M and X bits. Note that the N/X output is invalid during the instruction cycle following REP, SEP and PLP instruction execution. This cycle is used as the opcode fetch cycle of the next instruction.

8.9 All Opcodes Function in All Modes of Operation

8.9.1 It should be noted that all opcodes function in all modes of operation. However, some instructions and addressing modes are intended for W65C832 24-bit addressing and are therefore less useful for the W65C832. The following is a list of instructions and addressing modes which are primarily intended for W65C832 use:

JSL;RTL;[d];[d],y;JMP aI;JML;aI,aI,x

8.9.2 The following instructions may be used with the W65C832 even though a Bank Address is not multiplexed on the Data Bus:

PHK;PHB;PLB

8.9.3 The following instructions have "limited" use in the Emulation mode:

8.9.3.1 The REP and SEP instructions cannot modify the M and X bits when in the Emulation mode. In this mode the M and X bits will always be high (logic 1).

8.9.3.2 When in the Emulation mode, the MVP and MVN instructions use the X and Y Index Registers for the memory address. Also, the MVP and MVN instructions can only move data within the memory range 0000 (Source Bank) to 00FF (Destination Bank) for the W65C832, and 0000 to 00FF for the W65C832.

8.10 Indirect Jumps

The JMP (a) and JML (a) instructions use the direct Bank for indirect addressing, while JMP (a,x) and JSR (a,x) use the Program Bank for indirect address tables.

8.11 Switching Modes

When switching from the Native mode to the Emulation mode, the X and M bits of the Status Register are set high (logic 1), the high byte of the Stack is set to 01, and the high bytes of the X and Y Index Registers are set to 00. To save previous values, these bytes must always be stored before changing modes. Note that the low byte of the S, X and Y Registers and the low and high byte of the Accumulator (A and B) are not affected by a mode change.

8.12 How Hardware Interrupts, BRK, and COP Instructions Affect the Program Bank and the Data Bank Registers

- 8.12.1 When in the Native mode, the Program Bank register (PBR) is cleared to 00 when a hardware interrupt, BRK or COP is executed. In the Native mode, previous PBR contents is automatically saved on Stack.
- 8.12.2 In the Emulation mode, the PBR and DBR registers are cleared to 00 when a hardware interrupt, BRK or COP is executed. In this case, previous contents of the PBR are not automatically saved.
- 8.12.3 Note that a Return from Interrupt (RTI) should always be executed from the same "mode" which originally generated the interrupt.

8.13 Binary Mode

The Binary Mode is set whenever a hardware or software interrupt is executed. The D flag within the Status Register is cleared to zero.

8.14 WAI Instruction

The WAI instruction pulls RDY low and places the processor in the WAI "low power" mode. NMI-, IRQ- or RESET will terminate the WAI condition and transfer control to the interrupt handler routine. Note that an ABORT- input will abort the WAI instruction, but will not restart the processor. When the Status Register I flag is set (IRQ- disabled), the IRQ- interrupt will cause the next instruction (following the WAI instruction) to be executed without going to the IRQ- interrupt handler. This method results in the highest speed response to an IRQ- input. When an interrupt is received after an ABORT- which occurs during the WAI instruction, the processor will return to the WAI instruction. Other than RES- (highest priority), ABORT- is the next highest priority, followed by NMI- or IRQ- interrupts.

8.15 The STP instruction disables the PHI2 clock to all circuitry. When disabled, the PHI2 clock is held in the high state. In this case, the Data Bus will remain in the data transfer state and the Bank address will not be multiplexed onto the Data Bus. Upon executing the STP instruction, the RES- signal is the only input which can restart the processor. The processor is restarted by enabling the PHI2 clock, which occurs on the falling edge of the RES- input. Note that the external oscillator must be stable and operating properly before RES- goes high.

8.16 COP Signatures

Signatures 00-7F may be user defined, while signatures 80-FF are reserved for instructions on future microprocessors. Contact WDC for software emulation of future microprocessor hardware functions.

8.17 WDM Opcode Use

The WDM opcode will be used on future microprocessors.

8.18 RDY Pulled During Write

The NMOS 6502 does not stop during a write operation. In contrast, both the W65C02 and the W65C832 do stop during write operations. The W65C832 stops during a write when in the Native mode, but does not stop when in the Emulation mode.

8.19 MVN and MVP Affects on the Data Bank Register

The MVN and MVP instructions change the Data Bank Register to the value of the second byte of the instruction (destination bank address).

8.20 Interrupt Priorities

The following interrupt priorities will be in effect should more than one interrupt occur at the same time:

RES-	Highest Priority
ABORT-	
NMI-	
IRQ-	Lowest Priority

8.21 Transfers from differing register sizes

All transfers from one register to another will result in a full 32-bit output from the source register. The destination register size will determine the number of bits actually stored in the destination register and the values stored in the processor Status Register. The following are always 16-bit transfers, regardless of the accumulator size:

TAS;TSA;TAD;TDA

8.22 Stack Transfers

When in the W65C02 Emulation mode, a 01 is forced into the high byte of the 16-bit stack pointer. When in the Native mode or W65C816 Emulation mode, the A Accumulator is transferred to the 16-bit stack pointer. Note that in both the Emulation and Native modes, the full 16 bits of the Stack Register are transferred to the A Accumulator regardless of the state of the M bit in the Status Register.

8.23 REP/SEP

WDC had problems using the REP and SEP instructions in early versions of the high-speed W65C816 and W65C802 devices and has been corrected on all W65C832 devices.