

PROGRAMMABLE PRECISION REFERENCES

The KIA2431P/S/T/M/AP/AS/AT/AM/BM are integrated circuits are three-terminal programmable shunt regulator diodes. These monolithic IC voltage reference operate as a low temperature coefficient zener which is programmable from V_{ref} to 16 volts with two external resistors.

These devices exhibit a wide operating current range of 80 μ A to 50mA with a typical dynamic impedance of 0.22 Ω .

The characteristics of these references make them excellent replacements for zener diodes in many applications such as digital voltmeters, power supplies, and op amp circuitry.

FEATURES

- Programmable Output Voltage to 16 Volts.

LINE UP

ITEM	Package	Vref Tolerance (%)
KIA2431	P TO-92	± 1.5
	S TSM	
	T TSV	
	M SOT-23	
KIA2431	AP TO-92	± 1.0
	AS TSM	
	AT TSV	
	AM SOT-23	
KIA2431	BM SOT-23	± 0.5

- Low Dynamic Output Impedance : 0.22 Ω (Typ.).
- Sink Current Capability of 80 μ A to 50mA.
- Equivalent Full-Range Temperature Coefficient of 30ppm/ $^{\circ}$ C (Typ.).
- Temperature Compensated for Operation Over Full Rated Operating Temperature Range.
- Low Output Noise Voltage.

Marking

Type No.	Marking
KIA2431T/S/M	24A
KIA2431AT/AS/AM	24B
KIA2431BM	24C

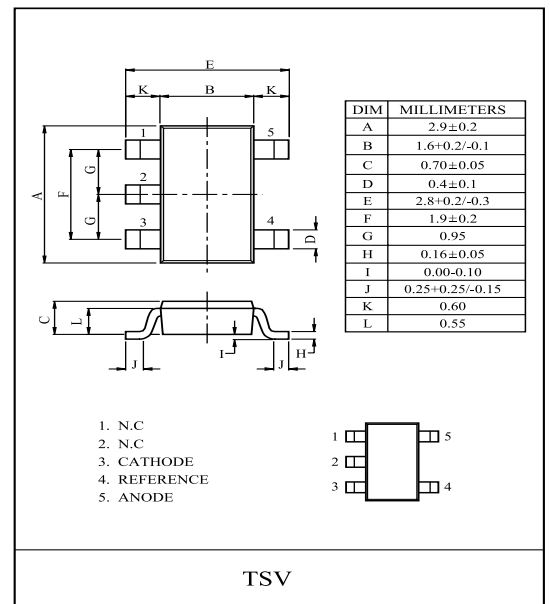
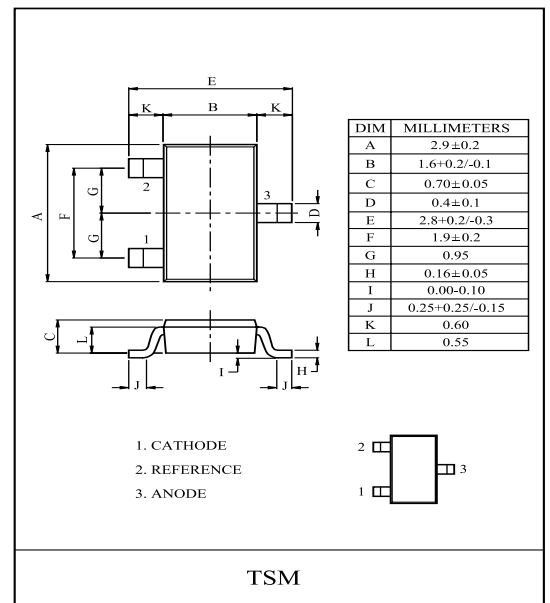
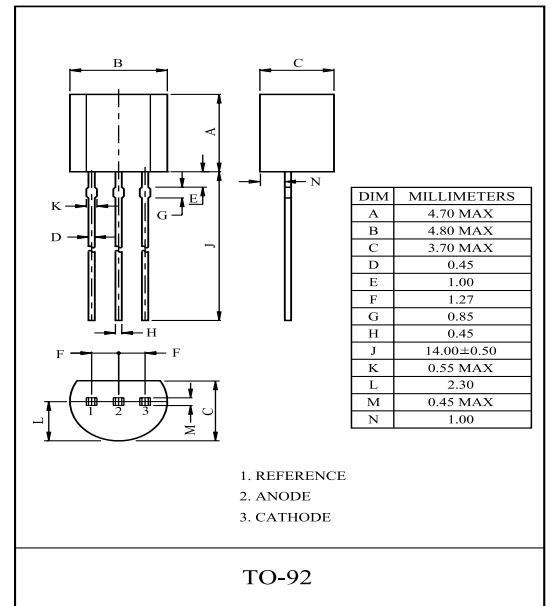
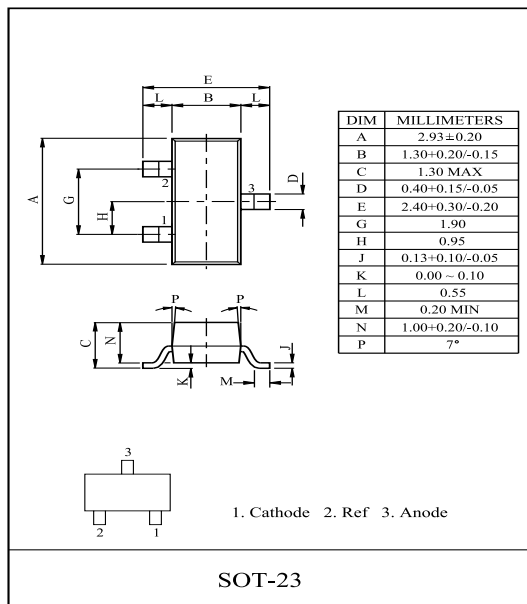

KIA2431P/S/T/M/AP/AS/AT/AM/BM

MAXIMUM RATINGS (Ta=25 °C)

(Full operating ambient temperature range applies unless otherwise noted.)

CHARACTERISTIC		SYMBOL	RATING	UNIT
Cathode To Anode Voltage		V_{KA}	16	V
Cathode Current Range, Continuous		I_K	50	mA
Reference Input Current Range, Continuous		I_{ref}	3	mA
Operating Junction Temperature		T_j	150	
Operating Temperature		T_{opr}	-40 85	
Storage Temperature		T_{stg}	-65 150	
Total Power Dissipation	KIA2431P/AP	P_D	700	mW
	KIA2431S/AS (Note1)		900	
	KIA2431T/AT		550	
	KIA2431AM/BM (Note2)		350	

Note1) Package Mounted on 99.5% Alumina (10mm × 8mm × 0.6mm)

Note2) Package Mounted on a ceramic board (600mm² × 0.8mm)

BLOCK DIAGRAM

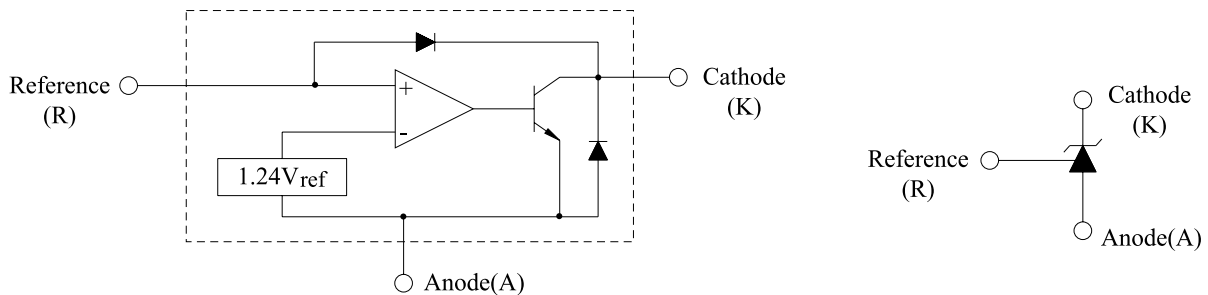

ELECTRICAL CHARACTERISTICS (Ta=25 °C)

CHARACTERISTICS		SYMBOL	TEST CIRCUIT	TEST CONDITION	MIN.	TYP.	MAX.	UNIT
Reference Input Voltage	KIA2431P/S/T/M	V_{ref}	Figure 1	$V_{KA}=V_{ref}, I_K=10mA$	1.222	1.240	1.258	V
	KIA2431AP/AS/AT/AM				1.228	1.240	1.252	V
	KIA2431BM				1.234	1.240	1.246	V
Reference Input Voltage Deviation Over Temperature Range		V_{ref}	Figure 1 (Note 1)	$V_{KA}=V_{ref}, I_K=10mA$	-	7.0	20	mV
Ratio of Change in Reference Input Voltage to Change in Cathode to Anode Voltage		V_{ref}/V_{KA}	Figure 2	$I_K=10mA$ $V_{KA}=16V$	-	-0.6	-1.5	mV/V
Reference Input Current	Ta=25	I_{ref}	Figure 2	$I_K=10mA, R1=10k, R2=$	-	0.15	0.5	μA
Reference Input Current Deviation Over Temperature Range		I_{ref}	Figure 2	$I_K=10mA, R1=10k, R2=$	-	0.05	0.3	μA
Minimum Cathode Current For Regulation		I_{min}	Figure 1	$V_{KA}=V_{ref}$	-	55	80	μA
Off-State Cathode Current		I_{off}	Figure 3	$V_{KA}=16V, V_{ref}=0V$	-	2.6	1000	nA
Dynamic Impedance		Z_{ka}	Figure 1 (Note 2)	$V_{KA}=V_{ref}, I_K=0.08mA \sim 50mA,$ $f = 1.0kHz$	-	0.22	0.4	

KIA2431P/S/T/M/AP/AS/AT/AM/BM

FIGURE 1-TEST CIRCUIT FOR $V_{KA} = V_{ref}$

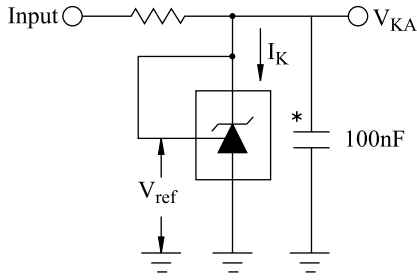
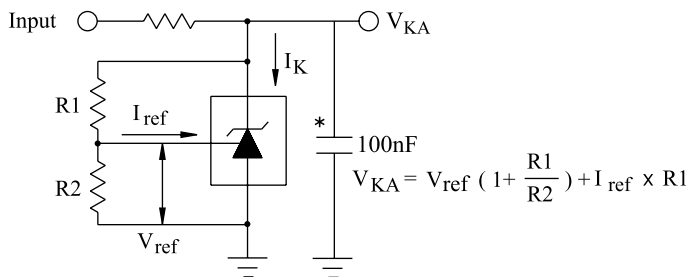

FIGURE 2-TEST CIRCUIT FOR $V_{KA} > V_{ref}$



* C_{KA} greater than 100nF is needed for stability.

Note 1:

The deviation parameter V_{ref} is defined as the differences between the maximum and minimum values obtained over the full operating ambient temperature range that applies.

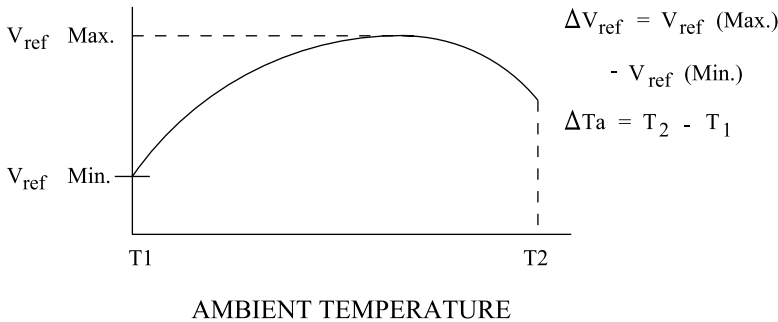

The average temperature coefficient of the Reference input voltage, V_{ref} , is defined as:

$$V_{ref} \left(\frac{\text{ppm}}{\text{Ta}} \right) = \frac{\left(\frac{V_{ref}}{V_{ref \text{ at } 25}} \right) \times 10^6}{\text{Ta}}$$

$$= \frac{V_{ref} \times 10^6}{\text{Ta}(V_{ref \text{ at } 25})}$$

V_{ref} can be positive or negative depending on whether $V_{ref \text{ Min.}}$ or $V_{ref \text{ Max.}}$ occurs at the lower ambient temperature.

FIGURE 3-TEST CIRCUIT FOR I_{off}

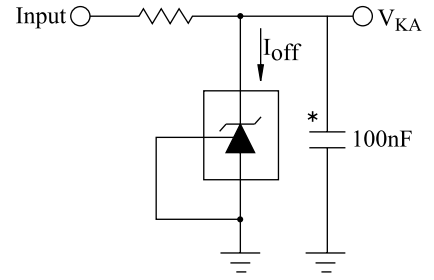

Example : $V_{ref} = 5.0\text{mV}$ and slope is positive,
 $V_{ref \text{ at } 25} = 1.245\text{V}$, $T_a = 110$

$$V_{ref} = \frac{0.005 \times 10^6}{110 \times 1.245} = 36.5 \text{ ppm/}$$

Note 2: The dynamic impedance Z_{ka} is defined as:

$$|Z_{ka}| = \frac{V_{KA}}{I_k}$$

When the device is programmed with two external resistors, R1 and R2, (refer to Figure 2) the total dynamic impedance of the circuit is defined as:

$$|Z_{ka}| = |Z_{ka}| \left(1 + \frac{R1}{R2} \right)$$

KIA2431P/S/T/M/AP/AS/AT/AM/BM

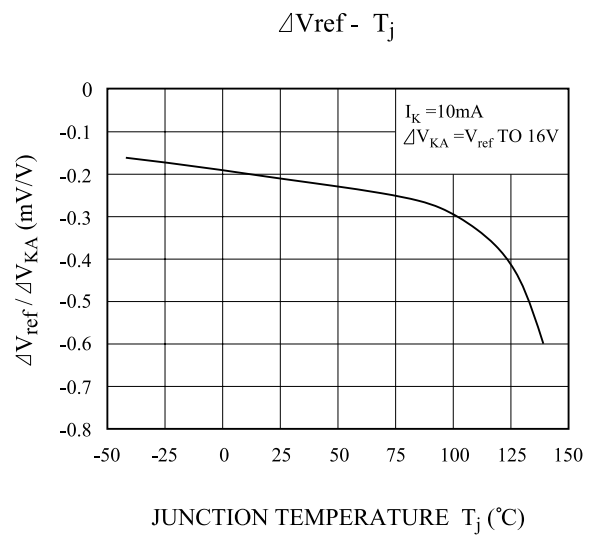
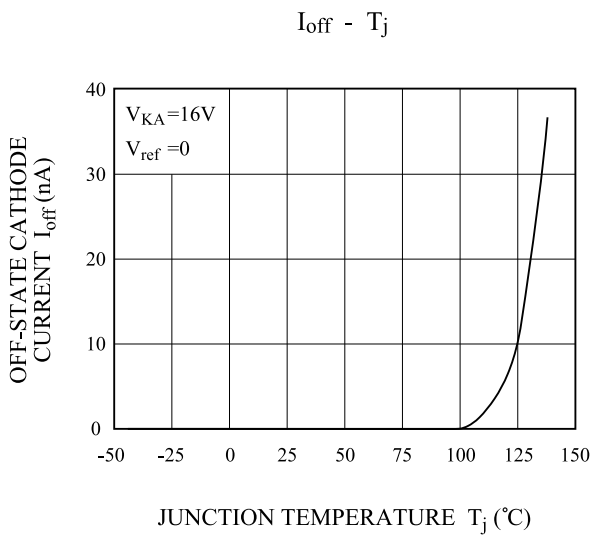
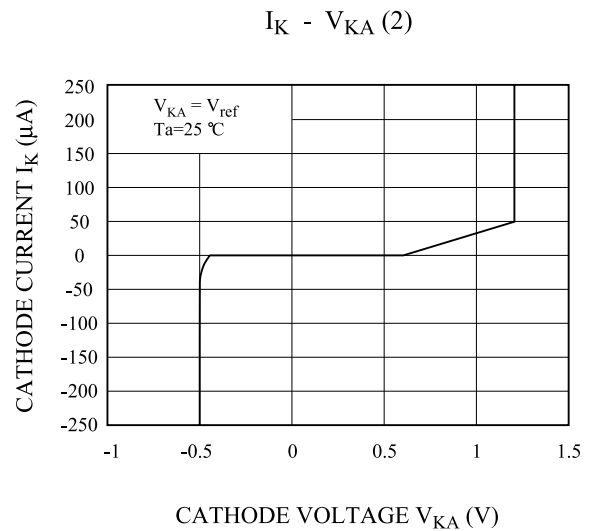
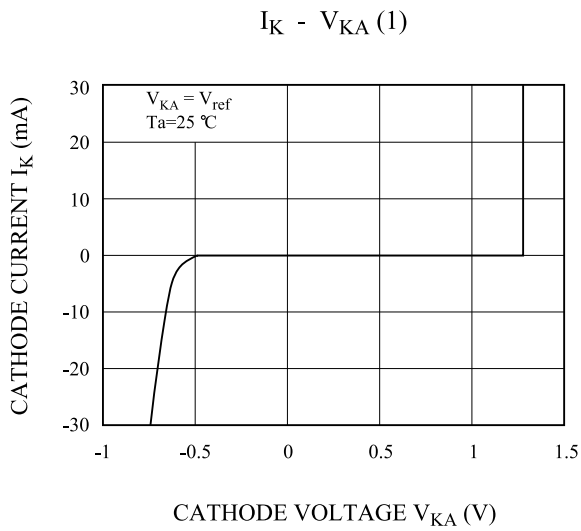
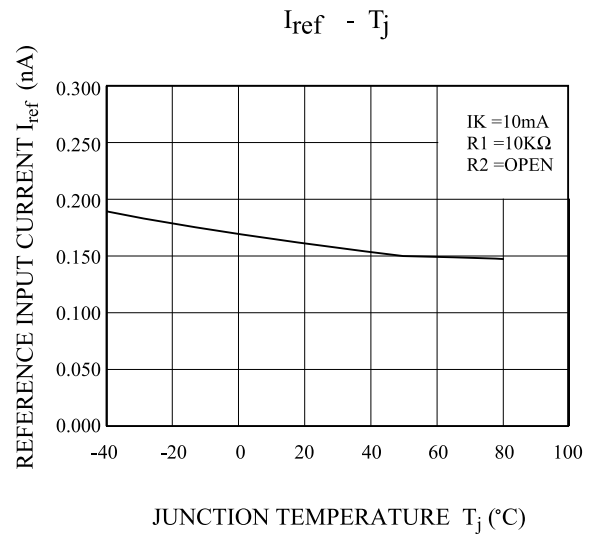
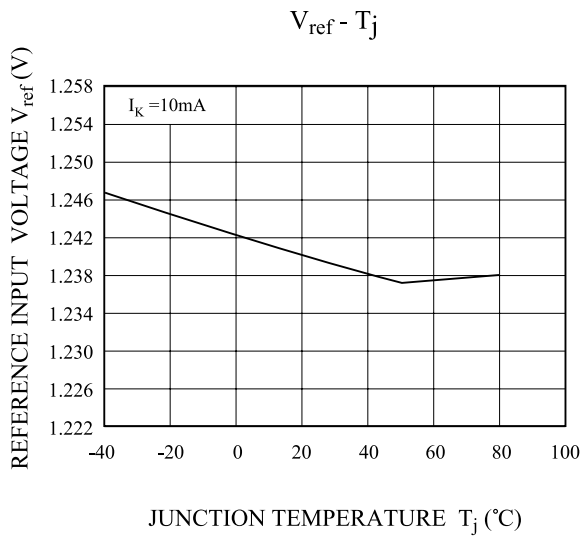

KIA2431P/S/T/M/AP/AS/AT/AM/BM

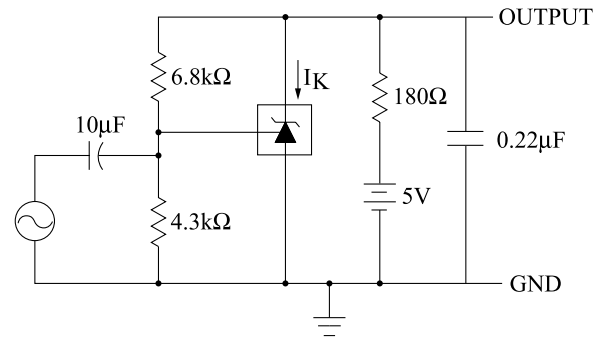
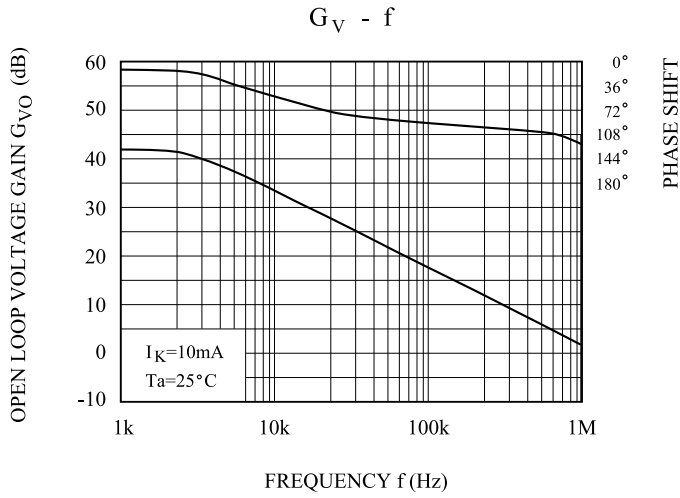

TEST CIRCUIT FOR VOLTAGE GAIN AND PHASE MARGIN

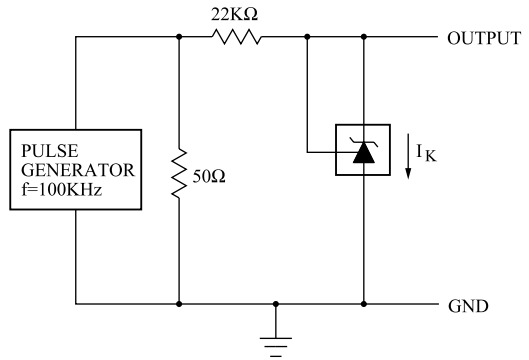
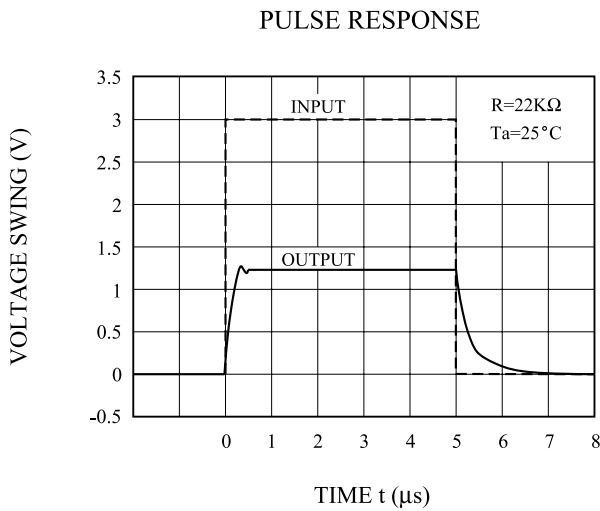

TEST CIRCUIT FOR PULSE RESPONSE2

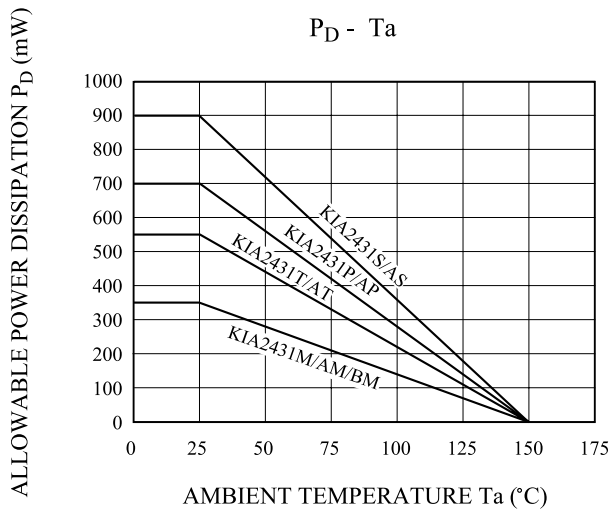

PRECAUTION FOR USE

SOLDERING

Flat Package (TSM/TSV/SOT-23 Package)

Elements mounting styles of electronic devices are gaining in further diversification over recent years, and needs for components are all the more expanding in varieties. Especially, surface mounting is steadily penetrating into industrial segments as a world-wide popular technical trend.

Although exposure to high temperature is inevitable during soldering we recommend limiting the soldering temperature to low levels as shown in figure for the sake of retaining inherent excellent reliability.

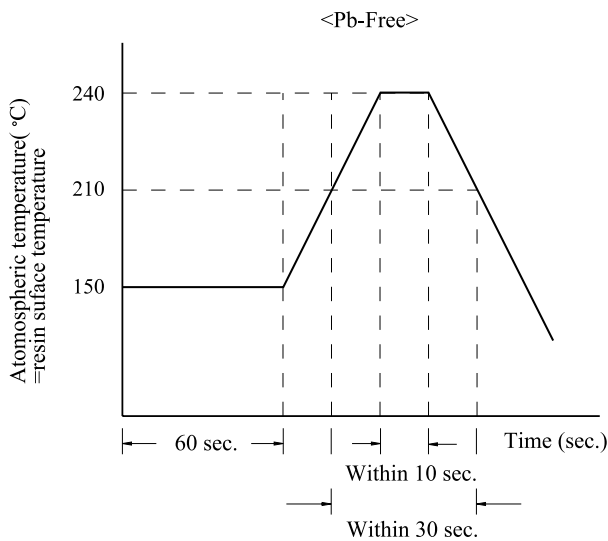

Fig. 6

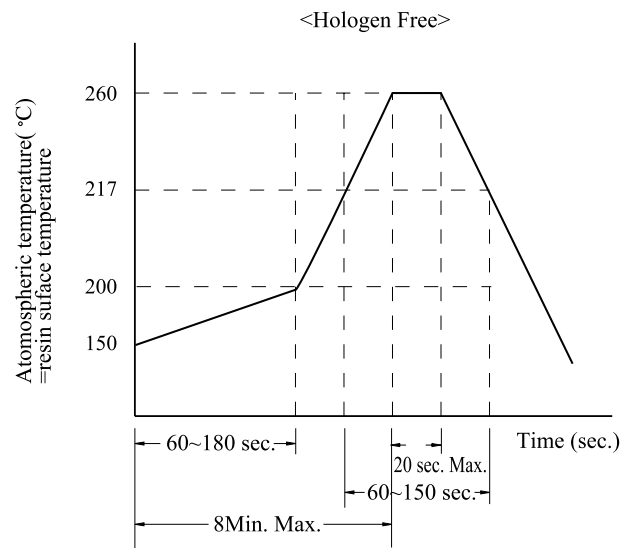

Fig. 7

(a) When employing solder reflow method

Atmospheric temperature around resin surfaces must be less than 240 °C, not exceeding the time length of 10 sec.

Recommend temperature profile

Precautions on heating method

When resin is kept exposed to high temperature for a long time, device reliability may be marred.

Therefore, it is essential to complete soldering in the shortest time possible to prevent temperature of resin from rising.

(b) When employing halogen lamps or infrared-ray heaters

When halogen lamps or infrared-ray heaters are used, avoid direct irradiation onto resin surfaces; such devices cause extensive localized temperature rise.

Please keep a reflow solder operating when TSM/TSV package's soldering.