

TENTATIVE TOSHIBA BIPOLAR LINEAR INTEGRATED CIRCUIT SILICON MONOLITHIC

TA1246F, TA1246AF

HI-FI AUDIO SIGNAL PROCESSOR FOR VHS VCR

FEATURES

- Bus line control (I²C-Bus)
- No adjustments of FM modulation center frequency f_0
- Auto adjustments of BPF center frequency f_0

MAIN FUNCTIONS

1. Hi-Fi audio processing

- Input / Output select switch
(4 Line IN to 1 Line Out)
- Electronic volume (Through / ALC / GCA)
- PNR (Peak Noise Reduction)
- 20 kHz LPF
- FM modulator-demodulator (NTSC / PAL)
- BPF
- Switching noise compensation

2. Others

- Logarithmic amplifier out for level meter
- Envelope detector out
- Provided line out mute transistors
- Mix out for RF conv. (Built-in ALC)

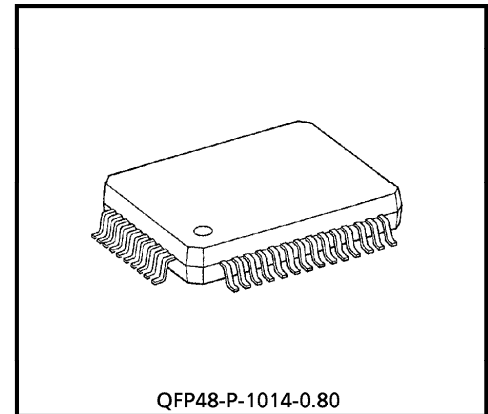

QFP48-P-1014-0.80

Weight : 1.47 g (Typ.)

980910EBA1

- TOSHIBA is continually working to improve the quality and the reliability of its products. Nevertheless, semiconductor devices in general can malfunction or fail due to their inherent electrical sensitivity and vulnerability to physical stress. It is the responsibility of the buyer, when utilizing TOSHIBA products, to observe standards of safety, and to avoid situations in which a malfunction or failure of a TOSHIBA product could cause loss of human life, bodily injury or damage to property. In developing your designs, please ensure that TOSHIBA products are used within specified operating ranges as set forth in the most recent products specifications. Also, please keep in mind the precautions and conditions set forth in the TOSHIBA Semiconductor Reliability Handbook.
- The products described in this document are subject to the foreign exchange and foreign trade laws.
- The information contained herein is presented only as a guide for the applications of our products. No responsibility is assumed by TOSHIBA CORPORATION for any infringements of intellectual property or other rights of the third parties which may result from its use. No license is granted by implication or otherwise under any intellectual property or other rights of TOSHIBA CORPORATION or others.
- The information contained herein is subject to change without notice.

BLOCK DIAGRAM

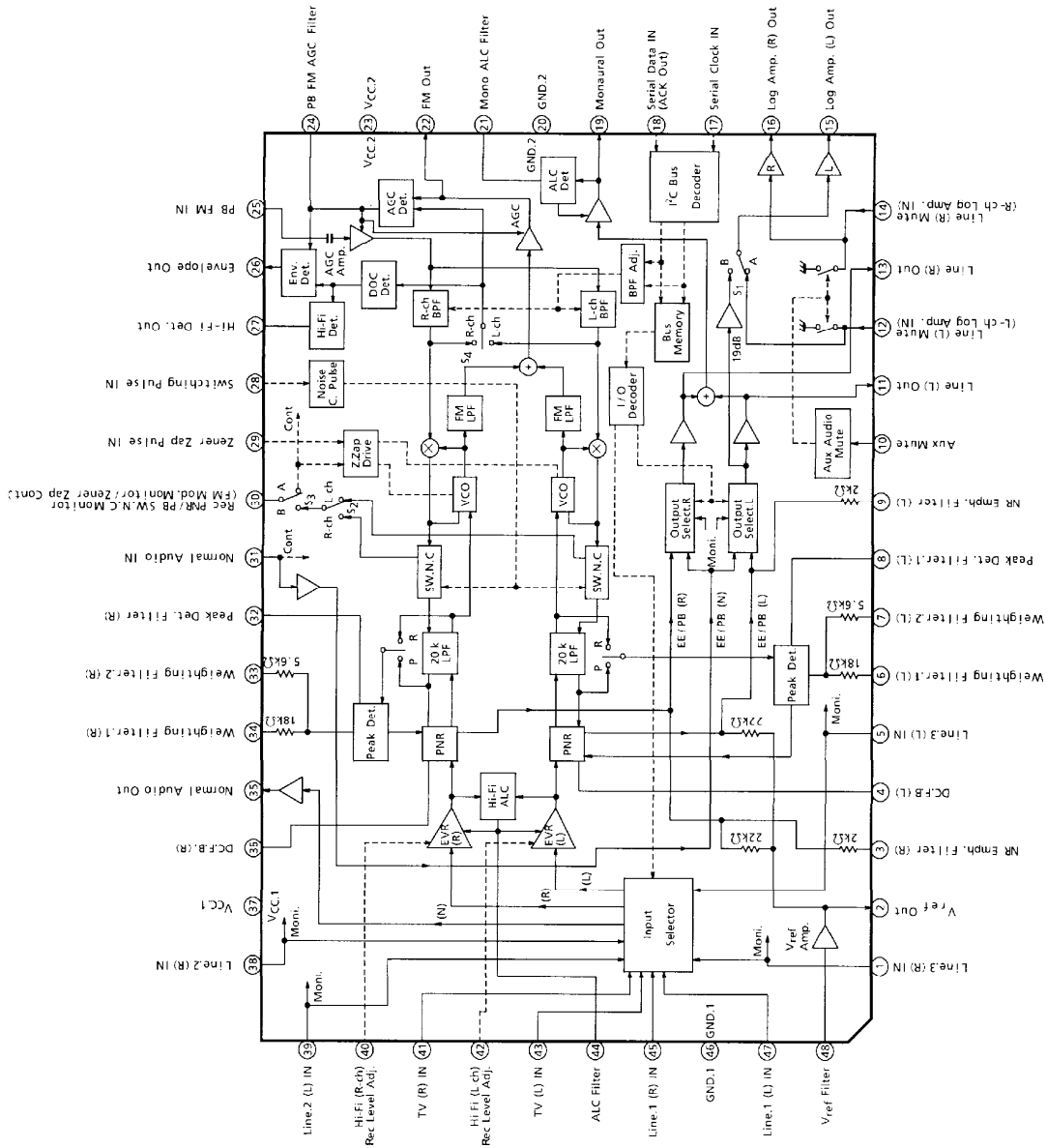

TA1246F/AF-2

TERMINAL CHARATERRISTICS ($V_{CC} = 9\text{ V}$, $T_a = 25^\circ\text{C}$)

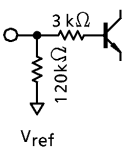
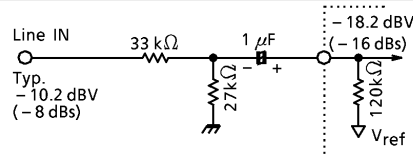
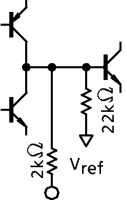
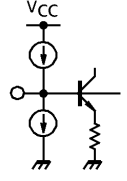
PIN No.	FUNCTION	TYP. DC VOLTAGE	TYP. AC VOLTAGE	INTERFACE	COMMENT
1	Line.3 (R) IN	4.5 V	Direct Input directly to terminal. - 18.2 dBV (- 16 dBs)		 <p>Following external circuits and internal input resistance of Line IN terminals are the same. Line.1 (L) IN : pin 47 Line.1 (R) IN : pin 45 Line.2 (L) IN : pin 39 Line.2 (R) IN : pin 38 Line.3 (L) IN : pin 5 Line.3 (R) IN : pin 1 TV (L) IN : pin 43 TV (R) IN : pin 45</p>
2	V_{ref} Out	4.5 V	—	1 Ω or less	<ul style="list-style-type: none"> Connect with external capacitor 330 μF. The BPF adjustment is reset with 7 / 18 V_{CC}.1.
3	NR Emph. Filter (R)	4.5 V	—		<ul style="list-style-type: none"> This terminal is used to decide the NR Emphasis time constant. Typ. capacitance : 0.01 μF (Please use high accuracy one.)
4	DC.F.B. (L)	4.5 V	—		Connect with a capacitor for DC offset elimination of PNR circuit.
5	Line.3 (L) IN	4.5 V	Direct - 18.2 dBV (- 16 dBs)	120 k Ω	Refer to the pin 1 : Lline.3 (R) IN.

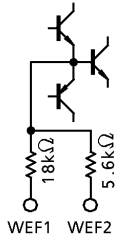
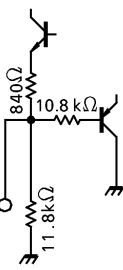
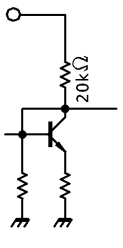
PIN No.	FUNCTION	TYP. DC VOLTAGE	TYP. AC VOLTAGE	INTERFACE	COMMENT
6	Weighting Filter.1 (L)	4.5 V	—		This terminal is used to set the weighting time constant. Filter.1 : 10 μF offset elimination Filter.2 : 0.01 μF We.T.C.
7	Weighting Filter.2 (L)				
8	Peak Det. Filter (L)	—	—		This terminal is used to set the Attack / Recovery time with an external capacitor. Typ. capacitance : 10 μF Attack time : 5 ms Recovery time : 70 ms Refer to (Remark 8).
9	NR Emph. Filter (L)	4.5 V	—	<ul style="list-style-type: none"> This terminal has the same function as pin 3 NR Emph. Filter (R). Refer to the explanation of pin 3. 	
10	Aux Mute	Open 0.1 V	—		<ul style="list-style-type: none"> External mute control terminal of Line Out. By pulling up this terminal to "High" (1.5 V~5.5 V), pin 12 and 14 turn to "GND" (muted). (Refer the application circuit.) Supplement : Since this terminal control is independent of Bus control, the mute function can be used at power Off, too, by pulling this terminal to "High". Note : Connect this terminal to GND, if the Aux Mute function is not used.
11	Line (L) Out	4.5 V	- 9.2 dBV (- 7 dBs)	SEPP	L-ch line output terminal.

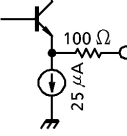
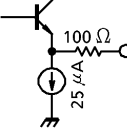
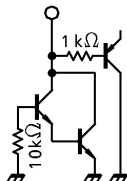
PIN No.	FUNCTION	TYP. DC VOLTAGE	TYP. AC VOLTAGE	INTERFACE	COMMENT
12	Line (L) Mute	At Mute ON : 0 V	—	At Mute ON $\leq 20 \Omega$	<ul style="list-style-type: none"> At Aux Mute ON (pin 10 : "High"), this terminal is shorted to GND below 20Ω. Supplement : It does not operate in the Mute command from the Bus control.
	(L-ch Log Amp. IN)	—	-9.2 dBV (-7 dBs)	8.3 k Ω	<ul style="list-style-type: none"> Input terminal of Log Amp. for level meter. Input impedance : 8.3 k Ω
13	Line (R) Out	4.5 V	-9.2 dBV (-7 dBs)	SEPP	R-ch line output terminal.
14	Line (R) Mute	At Mute ON : 0 V	—	At Mute ON $\leq 20 \Omega$	<ul style="list-style-type: none"> This terminal has the same function as pin 12 Line Mute. Refer to the explanation of pin 12.
	(R-ch Log Amp. IN)	—	-9.2 dBV (-7 dBs)	8.3 k Ω	<ul style="list-style-type: none"> This terminal has the same function as pin 12 L-ch Log Amp. IN. Refer to the explanation of pin 12.
15	Log Amp. (L) Out	—	—		<ul style="list-style-type: none"> Logarithmic detector output terminal for level meter. Output voltage : 0~5 V Supplement : <ul style="list-style-type: none"> Refer to the (Remark 12). When Just Clock mode is selected by Bus, this output also functions during the Aux Mute ON. Setting procedure of Just Clock Mode : SA No.0 D7 (Log/J. Clock) → "1" Refer to (Remark 17) for more details of Just Clock mode.
16	Log Amp. (R) Out (Log Amp. (L) Input Select SW) Cont.	—	—		<ul style="list-style-type: none"> Logarithmic detector output terminal for level meter. Output voltage : 0~5 V Supplement : <ul style="list-style-type: none"> Refer to (Remark 12).
17	Serial Clock IN	V _{th} 2.25 V	—	 100 k Ω or greater	<ul style="list-style-type: none"> Clock input terminal of I²C-Bus. Note : Connect with external Pull UP resistor. (As a result, this terminal becomes "Open High" on board.) Pull UP resistance : 4.7 k Ω (Max. f = 500 kHz) Supplement : The voltage can be impressed also at the V _{CC} OFF.

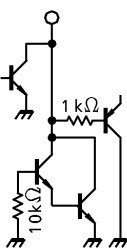
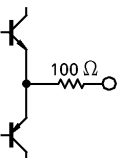
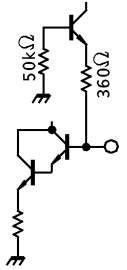
PIN No.	FUNCTION	TYP. DC VOLTAGE	TYP. AC VOLTAGE	INTERFACE	COMMENT
18	Serial Data IN (ACK Out)	V _{th} 2.25 V	—		<p>● Data input and ACK output terminal of I²C-Bus.</p> <p>Note :</p> <p>Connect with external Pull UP resistor. (As a result, this terminal becomes "Open High" on board.)</p> <p>Pull UP resistance : 4.7 kΩ (Max. f = 500 kHz)</p> <p>Supplement :</p> <p>Data input resistance : ≥ 100 kΩ Output resistance of ACK "Low" : ≤ 300 Ω (ACK 0.3 V : 14 mA can be pull in.) The voltage can be impressed also at the V_{CC} OFF.</p>
19	Monaural Out	4.5 V	-9.2 dBV (-7 dBs)		<p>Monaural output for RF Modulator. Refer to the (Remark 10).</p>
20	GND.2	—	—	—	GND for FM circuit. (V _{CC} : 5 V)
21	Mono ALC Filter	—	—		<p>ALC filter terminal for monaural out. Supplement :</p> <p>The Mono ALC does not function when this terminal is connected with GND.</p>

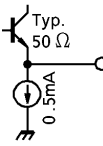
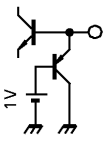
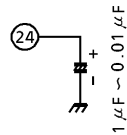
PIN No.	FUNCTION	TYP. DC VOLTAGE	TYP. AC VOLTAGE	INTERFACE	COMMENT
22	FM Out (BPF Monitor Out)	2.5 V	1.05 V _{p-p}		<p>FM Modulation output. (L/R Mix Out)</p> <p>Supplement 1 : An output channel can be selected at Rec mode. (L-ch or R-ch) Method : (Refer to the (Remark 16) for details.) 1) Pin 31 : open (Refer to the "Additional function 1 of pin 31.) 2) Impress the voltage to pin 30 (FM Mod. Monitor Cont.)</p> <ul style="list-style-type: none"> The L/R Mix ratio is varied by Bus control. <p>Supplement 2 : The BPF characteristic can be monitored at PB via the route "pin 25 (PB FM IN) → BPF → pin 22". Method : (Refer to the (Remark 16) for details.) 1) Pin 27 (Hi-Fi Det. Out) : 9.0 V 2) The monitored channel is switched by impressing the voltage to pin 31. (Refer to the "Additional function 2 of pin 31.) Pin 31 : 9 V : R-ch, GND : L-ch</p> <ul style="list-style-type: none"> As for demodulators in this IC, both L-ch and R-ch operate while monitoring though the monitored channel is one of them.
23	V _{CC.2}	5.0 V	—	—	V _{CC} for FM circuit : 5 V
24	PB FM AGC Filter	0~1.7 V	—		<p>Filter terminal of PB FM AGC Det.</p> <p>Supplement : AGC flat range : PB FM 50~150 mV_{p-p} (L-ch or R-ch component)</p>  <p>Reference channel of AGC is selected by Bus SA No.2 D₂. (R-ch : 0, L-ch : 1)</p>

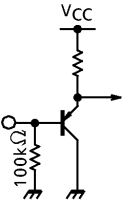
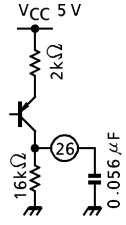
PIN No.	FUNCTION	TYP. DC VOLTAGE	TYP. AC VOLTAGE	INTERFACE	COMMENT
25	PB FM IN	0 V	Typ. 100 mV _{p-p}		PB FM input terminal. ● L/R mixed input level : Max 400 mV _{p-p} (Single component : Max. 200 mV _{p-p}) ● Non Hi-Fi Det. Level : 5 mV _{p-p} Supplement : PB FM Amp. of AGC input : 0 / +3 dB (Bus SA No.3 D ₁ (PB FM Gain)) at +3 dB mode typ. IN : 70 mV _{p-p}
26	ENV. Det. Out	0~4.3 V	—		The output terminal of Envelope detector of PB FM. (Connect with a capacitor.) This output terminal can be used for tracking adjustment. Note that the this output impedance is high. Supplement : ● Output voltage 0 V (Non Hi-Fi)~4.3 V (Hi-Fi) Non Hi-Fi : 0.1 V of less

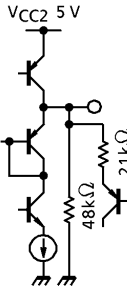
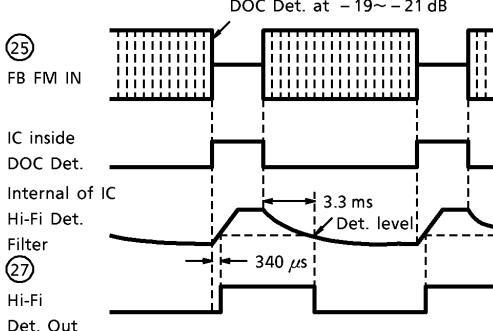
PIN No.	FUNCTION	TYP. DC VOLTAGE	TYP. AC VOLTAGE	INTERFACE	COMMENT
27	Hi-Fi Det. Out	0 / 4.3 V	—		<p>Output terminal of PB FM detection.</p> <p>Supplement 1 :</p> <ul style="list-style-type: none"> ● Output voltage 0V (Hi-Fi) / 4.3 V (Non Hi-Fi) ● Output resistance Hi-Fi : 48 kΩ Non Hi-Fi : Typ. 100 Ω <p>Supplement 2 :</p> <p>(*) The drop out detection level is -19~ -21 dB. The timing of the Non. Hi-Fi detection is shown in the following figures. Refer to (Remark 14 and 15) for details. Moreover, set the Mute by the Bus control at the trick.</p> <div style="display: flex; align-items: flex-start;"> <div style="margin-right: 20px;"> <p>②⑤ FB FM IN</p> <p>IC inside DOC Det.</p> <p>Internal of IC Hi-Fi Det. Filter</p> <p>②⑦ Hi-Fi Det. Out</p> </div> <div>  </div> </div> <p>Supplement 3 :</p> <p>(Refer the pin 22, 30 and 31)</p> <ul style="list-style-type: none"> ● Impress 9.0 V to this terminal for following test modes. BPF monitor mode ON : At PB mode, the output signal of BPF can be monitored at pin 22. Pin 30 monitor output R-ch select : The monitor output switches to R-ch. ● Audio signal of Line Out and Monaural Out turn into Norm. Audio at Non. Hi-Fi. (Refer to (Remark 16) for details.)

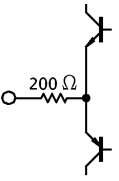
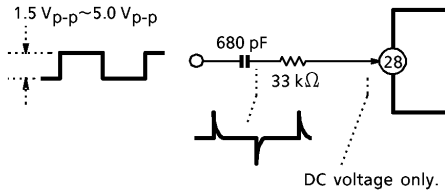
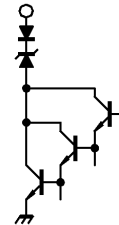
PIN No.	FUNCTION	TYP. DC VOLTAGE	TYP. AC VOLTAGE	INTERFACE	COMMENT
28	Switching Pulse IN	4.5 V	—		<p>Pulse input terminal for switching noise compensation. Current input type. Threshold : 50 μA Typ. Supplement : The CR current conversion as the following figure is necessary in case of voltage pulse. Pulse Level : 1.5 V_{p-p}~5.0 V_{p-p}</p> 
29	Zener Zap Pulse IN	Open	—		<p>Zener Zap pulse input terminal. Note : Please do not use this terminal and connect with GND because this terminal is used for manufacture.</p>

PIN No.	FUNCTION	TYP. DC VOLTAGE	TYP. AC VOLTAGE	INTERFACE	COMMENT
30	FM Mod. Monitor Cont.	4.5 V	- 10.2 dBV (- 8 dBs)	SEPP 100 Ω or less	<p>Test terminal for evaluation. (Refer to (Remark 16).) This terminal is usually used to control the L/R selection of Rec FM Out. Threshold 5 V : L-ch GND : R-ch</p>
	(Zener Zap Cont.)				<p>Supplement : Zap mode ON : Zener Zap writing mode is turned ON by connecting with V_{CC1} (9 V). Note : Don't use this mode usually because this control is used when the IC is manufactured.</p>
	(Rec. PNR / PB) (SW.N.C Monitor)				<p>By connecting pin 31 with GND, this terminal works as the following waveform monitor. <ul style="list-style-type: none"> ● At Rec : PNR output ● At PB : After Switching Noise Compensation. Supplement : These outputs are usually L-ch waveform, but you can select R-ch by impressing 9.0 V to pin 27. Note : This terminal usually works as s control input, not a monitor output. Therefore, please sat the monitor mode with pin 31 before monitoring. Moreover, please do not impress the forced voltage to pin 30 at the monitor mode.</p>

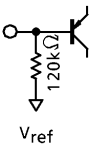
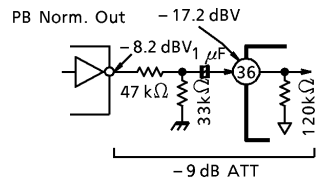
PIN No.	FUNCTION	TYP. DC VOLTAGE	TYP. AC VOLTAGE	INTERFACE	COMMENT
31	Normal Audio IN	4.5 V	- 17.2 dBV (- 15.0 dBs)		Normal audio input terminal for PB (possible at EE). Supplement 1 : Gain from pin 31 to line Out is 9 dB. Supplement 2 : Please insert an external attenuator before input, if the output level of the normal audio IC is high. Example : 
	(Monitor / Cont.) (Mode SW)				This terminal has the following functions concurrently. (Refer to the pin 22, 27 and 30.) Additional function 1 (Rec mode) : <ul style="list-style-type: none"> The function of pin 30 is selected as a control input or waveform monitor. Setting : Connect with... Open : Pin 30 Control Mode GND : Pin 30 Monitor Mode
	(BPF Monitor) (L / R Select)				Additional function 2 (PB mode) : <ul style="list-style-type: none"> L-ch / R-ch selection of BPF monitor (pin 22) at PB. Setting : Connect with... 9 V : Pin 22 BPF R-ch Monitor GND : Pin 22 BPF L-ch Monitor
32	Peak Det. Filter (R)	—	—	<ul style="list-style-type: none"> This terminal has the same function as pin 8 but R-ch. Refer to pin 8. 	
33	Weighting Filter.2 (R)	4.5 V	—	<ul style="list-style-type: none"> This terminal has the same function as pin 7 but R-ch. Refer to pin 7. 	
34	Weighting Filter.1 (R)			<ul style="list-style-type: none"> This terminal has the same function as pin 6 but R-ch. Refer to pin 6. 	
35	Normal Audio. Out	4.5 V	- 10.2 dBV (- 8 dBs)	SEPP	Output terminal for Normal audio IC at Rec. Supplement : Use pin 3 Line.3 (L) as SAP input at applying to SAP.

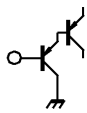
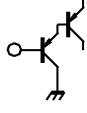
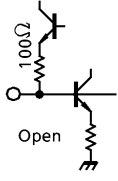
PIN No.	FUNCTION	TYP. DC VOLTAGE	TYP. AC VOLTAGE	INTERFACE	COMMENT
36	DC.F.B (R)	4.5 V	—	—	● This terminal has the same function as pin 4 but R-ch. Refer to pin 4.
37	V _{CC.1}	9.0 V	—	—	V _{CC} for NR circuit : 9 V
38	Line.2 (R) IN	4.5 V	Direct – 18.2 dBV (– 16 dBs)	120 kΩ	Refer to pin 1 : Line.3 (R) IN.
39	Line.2 (L) IN	4.5 V	Direct – 18.2 dBV (– 16 dBs)	120 kΩ	Refer to pin 1 : Line.3 (R) IN.
40	EVR (R-ch) Rec Level Adj.	Open 0 V	—		The control terminal for Hi-Fi Audio EVR (electronic variable resistor) level. Supplement : When EVR is used, EVR mode switch (ALC /Through /Manu) of Bus is set in "Manual". (SA No.1 D ₄ and D ₅) DC Adj. Width : 0~4.5 V (Typ. 1.8 V) Gain width : – ∞ ~14 dB (Typ. 0 dB) Open or GND when EVR unused.
41	TV (R) IN	4.5 V	Direct – 18.2 dBV (– 16 dBs)	120 kΩ	Refer to pin 1 : Line.3 (R) IN.
42	EVR (L-ch) Rec Level Adj.	Open 0 V	—		Refer to pin 40 : (R-ch) Rec Level Adj.
43	TV (L) IN	4.5 V	Direct – 18.2 dBV (– 16 dBs)	120 kΩ	Refer to pin 1 : Line.3 (R) IN.
44	ALC Filter	—	—		Filter terminal for EVR ALC. EVR ALC Attack Time : Set by built-in 100 Ω and external capacitance. EVR ALC Recovery Time : Set by external resistance and capacitance. (The GND connection is recommended at ALC unused.)
45	Line.1 (R) IN	4.5 V	Direct – 18.2 dBV (– 16 dBs)	120 kΩ	Refer to pin 1 : Line.3 (R) IN.

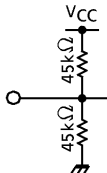
PIN No.	FUNCTION	TYP. DC VOLTAGE	TYP. AC VOLTAGE	INTERFACE	COMMENT
46	GND.1	—	—	—	GND for NR circuit (V_{CC} 9 V). We recommend the GND pattern is separated between this terminal and FM GND (pin 20) and filter's GND of NR is connected with this terminal.
47	Line.1 (L) IN	4.5 V	Direct – 18.2 dBV (– 16 dBs)	120 k Ω	Refer to pin 1 : Line.3 (R) IN.
48	V_{ref} Filter	4.5 V	—		<ul style="list-style-type: none"> • Connect with external capacitor for ripple rejection of signal lines. • V_{ref} rise time is set with external capacitance. (Note) Please use the same capacitance as the recommended application circuit. If a different constant is used, pop noise may be occurred.

Function explanation contents ... Operations and reference characteristics of this IC are showed afterwards.

- (Remark 1) Handling instruction for this IC and outline of Bus usage.
 - About Bus Control (I²C-Bus)
 - Data / Clock Input Format
 - Bit Map of Bus Control Mode
- (Remark 2) Rough sketch of block diagram
- (Remark 3) Input/output selector block diagram
- (Remark 4) Table of input/output selector control
- (Remark 5) Hi-Fi audio level chart (Rec)
- (Remark 6) Hi-Fi audio level chart (PB)
- (Remark 7) Hi-Fi audio electric volume characteristic (Rec)
- (Remark 8) PNR attack / recovery time
- (Remark 9) 20kHz LPF characteristic
- (Remark 10) Monaural out (to RF conv.) ALC characteristics
- (Remark 11) BPF
- (Remark 12) Characteristic of level meter log amp.
- (Remark 13) Characteristic of envelope det. out
- (Remark 14) PB FM drop out
- (Remark 15) PB FM mute (Non Hi-Fi detection)
- (Remark 16) Procedure of test mode
- (Remark 17) Method of using log amp. for just clock
- (Remark 18) FM mod. out temperature characteristic
- (Remark 19) FM mod. out voltage characteristic

OPERATIONS AND REFERENCE CHARACTERISTICS

(Remark 1) Handling instruction for this IC and outline of the Bus usage

1. This IC doesn't operate before receiving the Bus data, so it is necessary to send the Bus data first after power ON.
2. The Bus is transferred in order of Slave Address, Sub Address and Data. There are 7 addresses in all.
For the simplicity, Sub Address is sometimes represented in the decimal as "SA No. " in this document.
3. The control data of this IC is composed with 8bit without Slave and Sub Address. We represent the control data by a number of two figures in hexadecimal.

Ex. ... 8bit in binary : 10001111

↓

4 by 4 in binary : 1000 and 1111

↓

In decimal : 8 and 15

↓

In hexadecimal : 8 and F

↓

2 figures in hex. : 8F

4. The center frequency of FM Mod. has been already adjusted during IC manufacturing, so SA No.5 and 6 cannot be operated.
5. PB FM BPF is adjusted automatically. But manual adjustment mode exists, too. By select manual mode ON (SA No.1 D₆), you can adjust the center frequency of BPF by setting the Bus data from D₀ to D₇ on SA No.3 and 4.
6. It is Not necessary to set SA No. from 3 to 6 if you set the BPF mode "Auto".

BUS CONTROL MODE

	ADDRESS		DATA									
	SLAVE	SUB-ADD.	D7	D6	D5	D4	D3	D2	D1	D0		
0	11101010	00000000	Log / J.Clock	Hi-Fi Select SW		Rec Norm. Out Select SW		Mute	EE / Rec / PB			
1		00000001	Auto BPF (Requ-est)	BPF mode (Auto / Manu)	Rec EVR mode		Output SW					
2		00000010	FM Out L / R Mix Ratio	SW.N.C Pulse Width			PB FM AGC (R / L)	PB FM Gain	Mod. f ₀ / BPF (NTSC / PAL)			
3		00000011	END ZAP	Blank	BPF f ₀ L-ch Manual Adjust							
4		00000100	Blank	Blank	BPF f ₀ R-ch Manual Adjust							
5		00000101	FM Mod. f ₀ L-ch Adjust									
6		00000110	FM Mod. f ₀ R-ch Adjust									

Supplement : SA No.3 and 4 are not used because BPF center frequency is usually set with automatic adjustment mode.

: SA No.5 and 6 cannot be used because the center frequency of FM Mod. is usually set before shipping.

SA No. (Sub Address No) : It represent what kind of data is it at explaining of operations and method of measurements.

I²C-BUS OUTLINE

The I²C-Bus has two wires, serial data (SDA) and serial clock (SCL) which carry information between the ICs connected to the Bus. The Bus turns to busy after the Start Condition. And the Bus turns to free again after the Stop Condition.

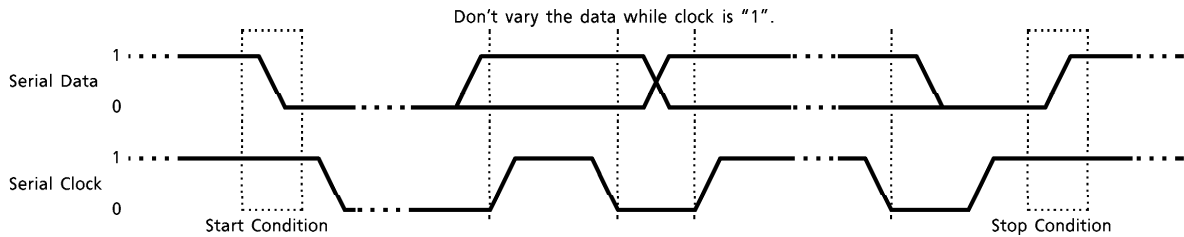

A HIGH to LOW transition of the SDA line while SCL is HIGH defines a Start Condition. A LOW to HIGH transition of the SDA line while SCL is HIGH defines a Stop Condition. (The inside of []) Start and stop of data transmissions follow the above-defined form.

DON'T Don't vary the data while clock is "1" at data transmission. The data signal follows the above-illustrated form.

If the slave IC receive the data successfully, it output acknowledge "Low" to the master IC (I²C Ack. Level Max. : 0.4 V). Acknowledge synchronize with every 9th clock of data. The connection between master and slave IC is illustrated as follows.

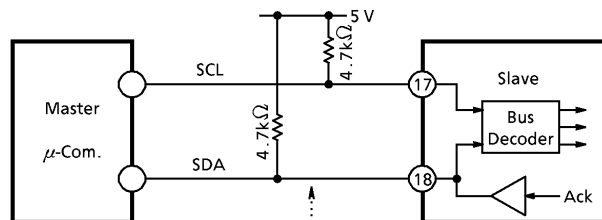

External Pull-Up resistors needed. ... If there is a pair of Pull-Up resistors with any of ICs which are controlled by I²C-Bus, it doesn't need more Pull-Up resistor for this IC.

BUS CONTROL INPUT FORMAT (I²C-BUS)

Format. 1 : Sub-add. and data input by turns.

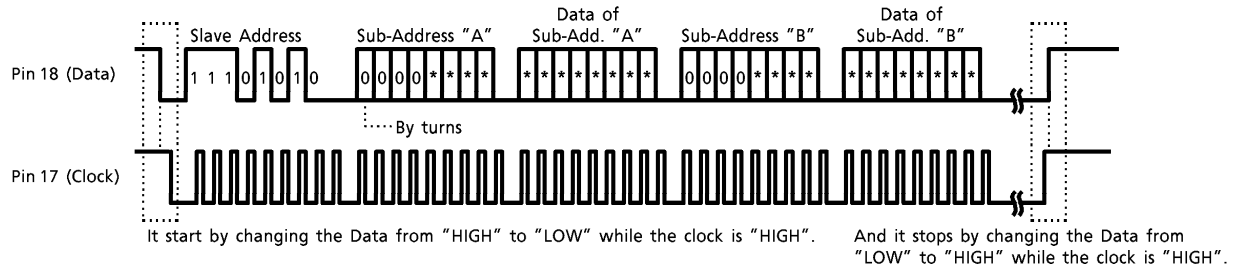

Format. 2 : Sub-add. input continually.

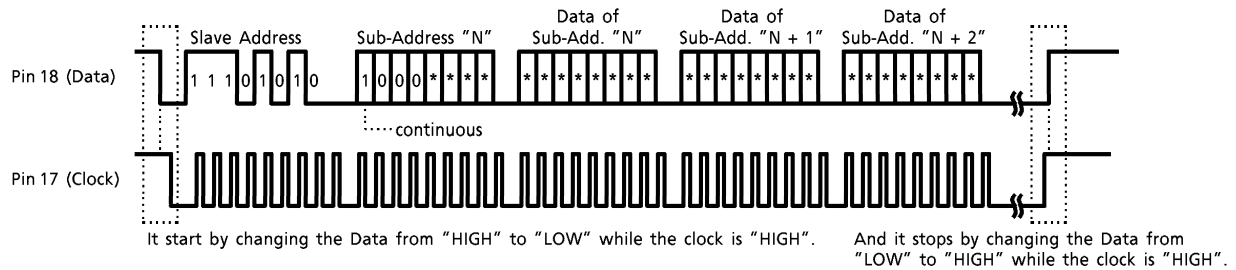

(Note 1) While the clock is "HIGH", don't vary the Data from "HIGH" to "LOW" or from "LOW" to "HIGH" to input data.

(Note 2) Do not change the format ("by turns" or "continually") on transmitting halfway.

BUS LINE MODE

□ : Initial Mode (At start up)

SA No.	BUS ITEM	MODE	SUB-ADD.	DATA								COMMENT
				D7	D6	D5	D4	D3	D2	D1	D0	
0	EE / Rec / PB	EE	00000000							0	0	EE mode : Rec FM Mod. is not outputted.
		Rec							0	1	Rec mode : Rec FM Mod. is outputted.	
		PB							1	0	PB mode :	
		PB							1	1		
	Mute	ON						0				Mute at Line Out & PB SW. N.C.. (Audio outputs signal (line out and monaural out) don't turn to Norm. Audio)
		OFF						1				
	Norm. Audio Input SW	Mix				0	0					Input Selector for Rec Norm. Audio IC Mix L or R-ch of Hi-Fi selected with D5 & D6. L-ch (Main) of Hi-Fi selected with D5 & D6. Apply to SAP : Line.3 (L) is selected.
		Dual				0	1					
		Line.3 (L)				1	0					
		Line.3 (L)				1	1					
	Hi-Fi Select SW	TV				0	0					Hi-Fi Audio Input Selector.
		Line.1				0	1					
		Line.2				1	0					
		Line.3				1	1					
	Log / J.Clock	Log				0						Normal state to use Logarithmic Amp.. (S ₁ : A)
		J.Clock				1						Just Clock mode. (S ₁ : B)

SA No.	BUS ITEM	MODE	SUB-ADD.	DATA								COMMENT
				D7	D6	D5	D4	D3	D2	D1	D0	
1	Output SW	Hi-Fi Select Out	00000001				0	0	0	0	Hi-Fi Stereo Out	
						0	0	0	1	Dual ch, L-ch Out		
						0	0	1	0	Dual ch, R-ch Out		
		Mute				0	0	1	1	Mute		
		Hi-Fi + Norm Mix Out				0	1	0	0	Mix out of Hi-Fi Stereo and Norm. Audio		
						0	1	0	1	Dual ch, Mix Out of Hi-Fi (L) and Norm. Audio		
						0	1	1	0	Dual ch, Mix Out of Hi-Fi (R) and Norm. Audio		
		Norm Out				0	1	1	1	Norm. Audio Out		
		Monitor Select Line.2 OUT				1	0	0	0	Line.2 Monitor : Stereo Out		
						1	0	0	1	Line.2 Monitor : L-ch Out		
						1	0	1	0	Line.2 Monitor : R-ch Out		
		Mute				1	0	1	1	Mute		
		Monitor Select Line.3 OUT				1	1	0	0	Line.3 Monitor : Stereo Out		
						1	1	0	1	Line.3 Monitor : L-ch Out		
				1	1	1	0	Line.3 Monitor : R-ch Out				
	Mute			1	1	1	1	Mute				
	Rec EVR mode	Through			0	0			EVR Through mode			
		Auto			0	1			EVR ALC mode			
		Through			1	0			EVR Through mode			
		Manual			1	1			EVR Manual Adj. mode			
	BPF mode (Auto / Manu)	Auto			0				BPF is adjusted automatically VCC ON.			
		Manual			1				Use this mode if BPF is adjusted by Manual.			
	Auto BPF (Request)	OFF			0				Shot only 1 pulse at request.			
		ON			1							

SA No.	BUS ITEM	MODE	SUB-ADD.	DATA								COMMENT
				D7	D6	D5	D4	D3	D2	D1	D0	
2	Mod. f ₀ /BPF (NTSC/PAL)	NTSC	00000010								0	Mod. f ₀ & BPF : 1.3 M / 1.7 MHz
		PAL									1	Mod. f ₀ & BPF : 1.4 M / 1.8 MHz
	PB FM Gain	0 dB									0	PB FM AGC Gain Selector "Norm / UP"
		3 dB									1	
	PB FM AGC (L/R)	R-ch								0		L/R Selector : PB FM AGC Det. Input and BPF Monitor.
		L-ch								1		
	SW.N.C. Pulse Width	11.6 μs					0	0	0			Variable Switching Noise Compensation Width.
		10 μs					0	0	1			
		8.5 μs					0	1	0			
		7.8 μs					0	1	1			
		7.4 μs					1	0	0			
		7.0 μs					1	0	1			
		6.7 μs					1	1	0			
		6.4 μs					1	1	1			
	FM L/R Mix Rasio	8.5 dB				0	0					Variable L/R Mix ratio of Rec FM Out.
		10 dB				0	1					
		12 dB				1	0					
		14 dB				1	1					

SA No.	BUS ITEM	MODE	SUB-ADD.	DATA								COMMENT
				D7	D6	D5	D4	D3	D2	D1	D0	
3	BPF f ₀ L-ch Manual Adjust	19.2%	00000011			0	0	0	0	0	0	Use for center frequency adjustment of BPF by manual. (Sat SA No.1 D ₆ BPF Mode "Manual")
		f ₀ Center				1	0	0	0	0	0	
		-19.2%				1	1	1	1	1	1	
		Blank				0						
	END ZAP	OFF				0						Test Bit for manufacturing • It is reserved for the end of FM Mod. f ₀ adjustment.
		ON				1						

SA No.	BUS ITEM	MODE	SUB-ADD.	DATA								COMMENT	
				D7	D6	D5	D4	D3	D2	D1	D0		
4	BPF f ₀ R-ch Manual Adjust	19.2%	00000100 ↓			0	0	0	0	0	0	Use for center frequency adjustment of BPF by manual. (Set SA No.1 D ₆ BPF Mode "Manual") Width of adjustment : ± 19.2% Max (0.6% / Step)	
		⋮											
		f ₀ Center				1	0	0	0	0	0		0
		⋮											
	- 19.2%				1	1	1	1	1	1	1		
	Blank				0								It is no matter whichever "0" or "1".
	Blank				1								It is no matter whichever "0" or "1".

SA No.	BUS ITEM	MODE	SUB-ADD.	DATA								COMMENT	
				D7	D6	D5	D4	D3	D2	D1	D0		
5	FM Mod f ₀ L-ch Adjust	- 17.5%	00000101 ↓	0	0	0	0	0	0	0	0	It is reserved for adjustment of FM Mod. center frequency at manufacturing.	
		⋮											
		f ₀ Center		1	0	0	0	0	0	0	0		0
		⋮											
17.5%			1	1	1	1	1	1	1	1			

SA No.	BUS ITEM	MODE	SUB-ADD.	DATA								COMMENT	
				D7	D6	D5	D4	D3	D2	D1	D0		
6	FM Mod f ₀ R-ch Adjust	- 17.5%	00000110 ↓	0	0	0	0	0	0	0	0	0	It is reserved for adjustment of FM Mod. center frequency at manufacturing.
		⋮		⋮	⋮	⋮	⋮	⋮	⋮	⋮	⋮		
		f ₀ Center		1	0	0	0	0	0	0	0		
		⋮		⋮	⋮	⋮	⋮	⋮	⋮	⋮	⋮		
		17.5%		1	1	1	1	1	1	1	1		

(Remark 2) Rough sketch of block diagram

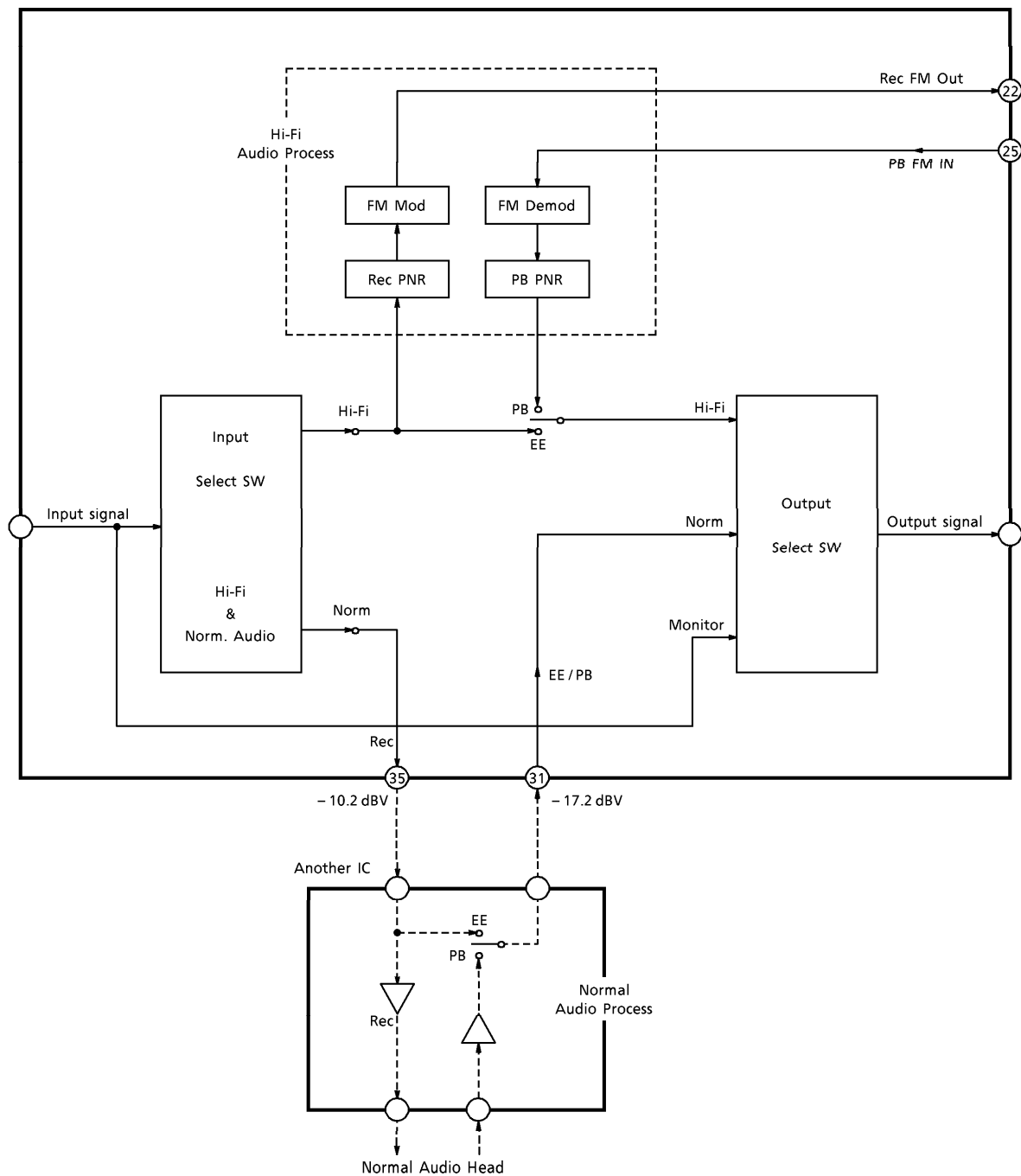

- Refer to (Remark 2) about table of Input / Output selector control.
- Refer to (Remark 3) (Input / output selector diagram).

(Remark 3) Input/output selector block diagram

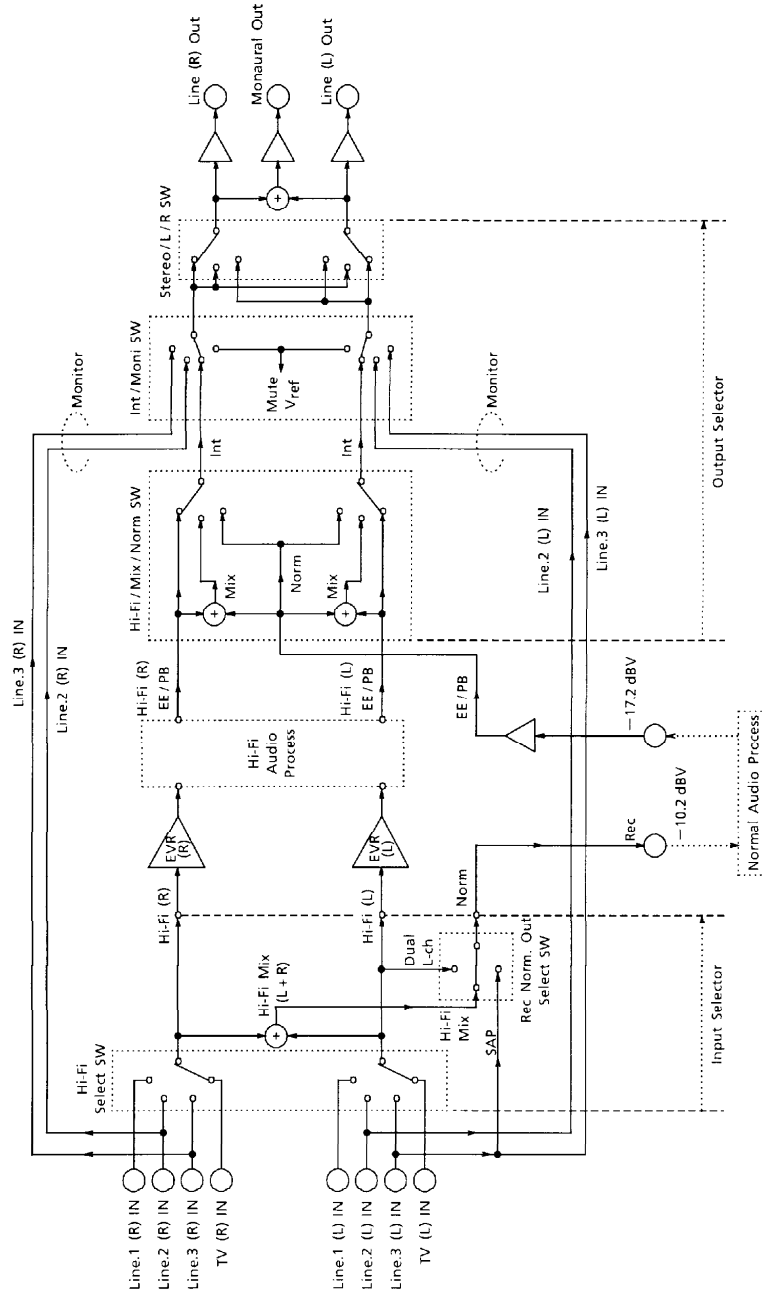

TA1246F / AF—26

(Remark 4)

Table of input selector control

BUS DATA				SELECTED INPUT SIGNAL		
Hi-Fi SELECT SW D ₆	SELECT SW D ₅	REC NORM. OUT SELECT SW D ₄	OUT SELECT SW D ₃	Hi-Fi (L)	Hi-Fi (R)	REC NORMAL OUT TERMINAL
0	0	0	0	TV (L)	TV (R)	TV (L + R)
0	0	0	1	TV (L)	TV (R)	TV (L)
0	0	1	*	TV (L)	TV (R)	Line.3 (L)
0	1	0	0	Line.1 (L)	Line.1 (R)	Line.1 (L + R)
0	1	0	1	Line.1 (L)	Line.1 (R)	Line.1 (L)
0	1	1	*	Line.1 (L)	Line.1 (R)	Line.3 (L)
1	0	0	0	Line.2 (L)	Line.2 (R)	Line.2 (L + R)
1	0	0	1	Line.2 (L)	Line.2 (R)	Line.2 (L)
1	0	1	*	Line.2 (L)	Line.2 (R)	Line.3 (L)
1	1	0	0	Line.3 (L)	Line.3 (R)	Line.3 (L + R)
1	1	0	1	Line.3 (L)	Line.3 (R)	Line.3 (L)
1	1	1	*	Line.3 (L)	Line.3 (R)	Line.3 (L)

Table of output selector control

BUS DATA				OUTPUT SIGNAL		
D ₃	OUTPUT SW D ₂	D ₁	D ₀	TERMINAL LINE (L) OUT	TERMINAL LINE (R) OUT	TERMINAL MONAURAL OUT
0	0	0	0	Hi-Fi (L)	Hi-Fi (R)	Hi-Fi (L + R)
0	0	0	1	Hi-Fi (L)	Hi-Fi (L)	Hi-Fi (L)
0	0	1	0	Hi-Fi (R)	Hi-Fi (R)	Hi-Fi (R)
0	1	0	0	Hi-Fi (L) + Norm	Hi-Fi (R) + Norm	Hi-Fi (L + R) + Norm
0	1	0	1	Hi-Fi (L) + Norm	Hi-Fi (L) + Norm	Hi-Fi (L) + Norm
0	1	1	0	Hi-Fi (R) + Norm	Hi-Fi (R) + Norm	Hi-Fi (R) + Norm
0	1	1	1	Norm	Norm	Norm
1	0	0	0	Line.2 (L)	Line.2 (R)	Line.2 (L + R)
1	0	0	1	Line.2 (L)	Line.2 (L)	Line.2 (L)
1	0	1	0	Line.2 (R)	Line.2 (R)	Line.2 (R)
1	1	0	0	Line.3 (L)	Line.3 (R)	Line.3 (L + R)
1	1	0	1	Line.3 (L)	Line.3 (L)	Line.3 (L)
1	1	1	0	Line.3 (R)	Line.3 (R)	Line.3 (R)

(Remark 5) Hi-Fi audio level chart (Rec)

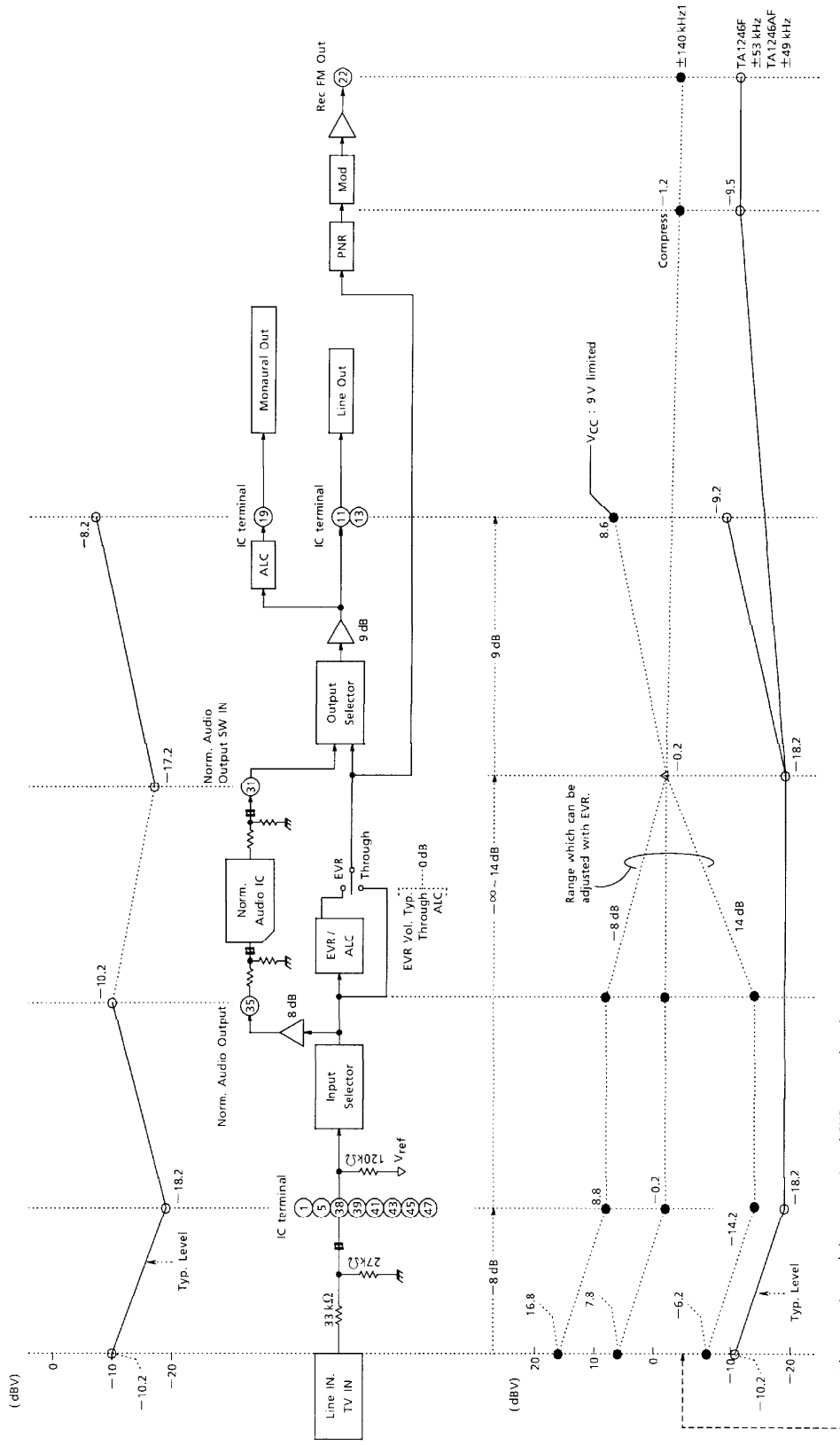

The expansion and the compression of PNR operate based on -2.2 dBV (0 dBs).

(Remark 6) Hi-Fi audio level chart (PB)

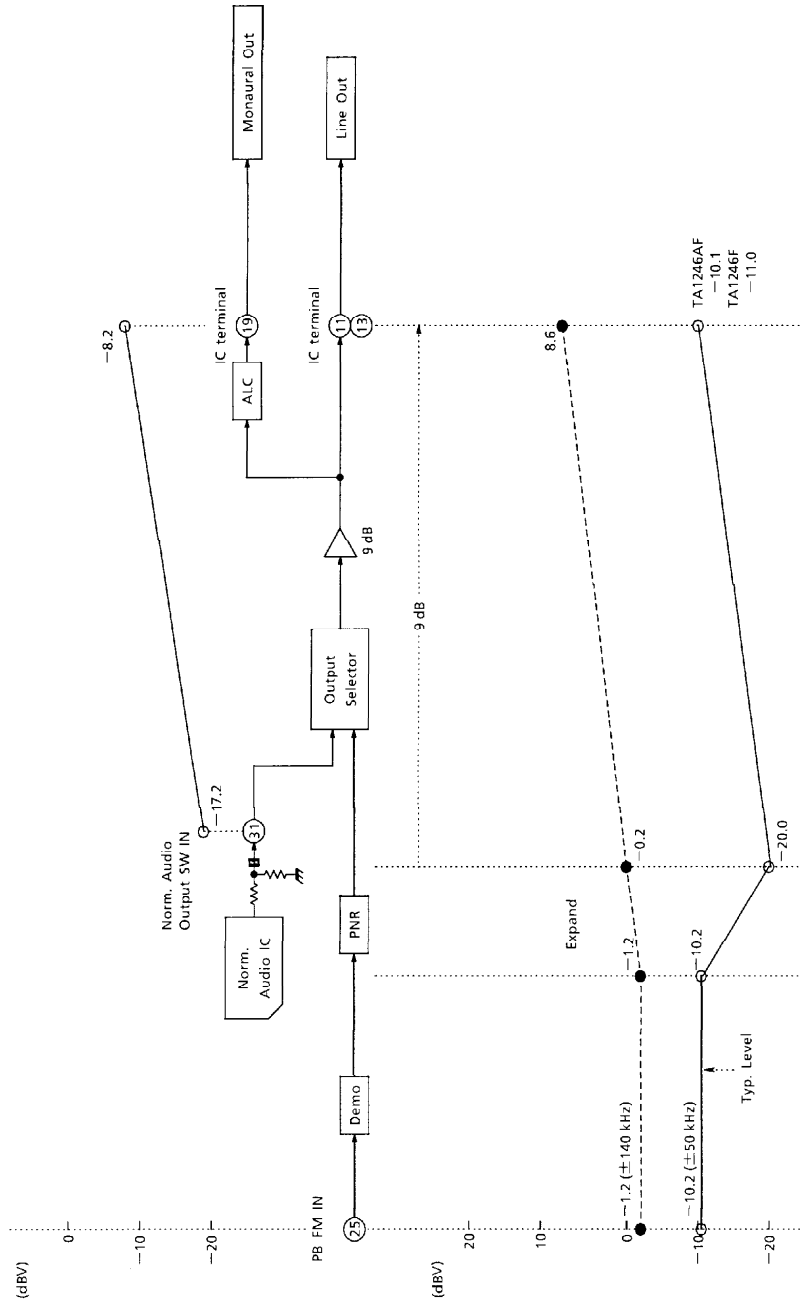

(Remark 7) Hi-Fi audio electric volume characteristic (Rec)

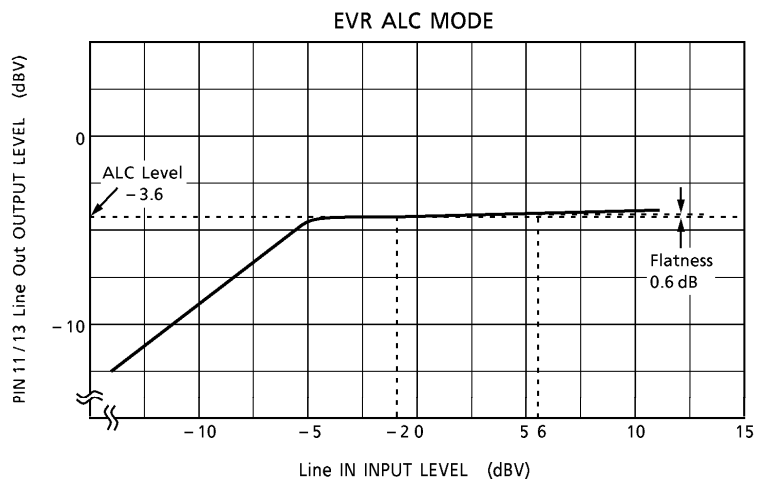
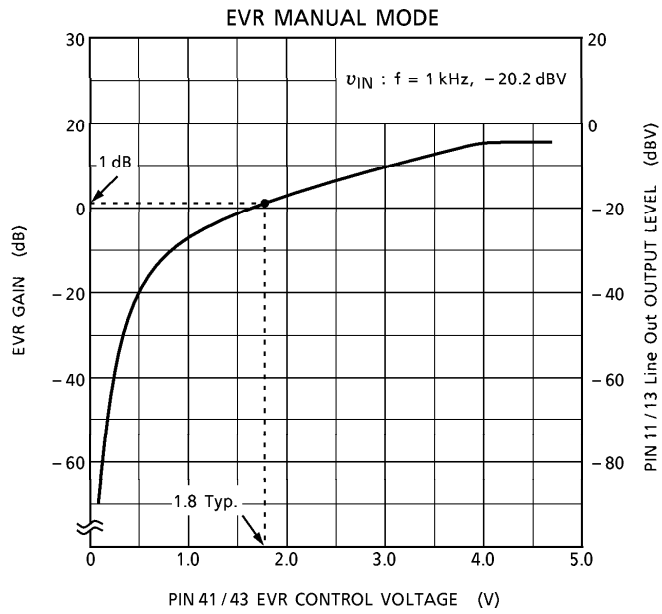

(Remark 8)

PNR attack / recovery / time

1. v_{IN} : TV IN (Pin 41, 43)
2.5 Hz (- 14.2 dBV) / 5 kHz (- 34.2 dBV) Tone-burst AM
2. v_{OUT} : Monitor Out (Pin 30)

(A voltage follower circuit is necessary to measure the characteristics.)
It is necessary to set the IC in Monitor Mode by impressing 9V to pin 27 to monitor the signal from pin 30. When monitoring, pin 30 is usually an output of L-ch. The output turn to R-ch by impressing 9V to pin 31. (Refer to remark 16)

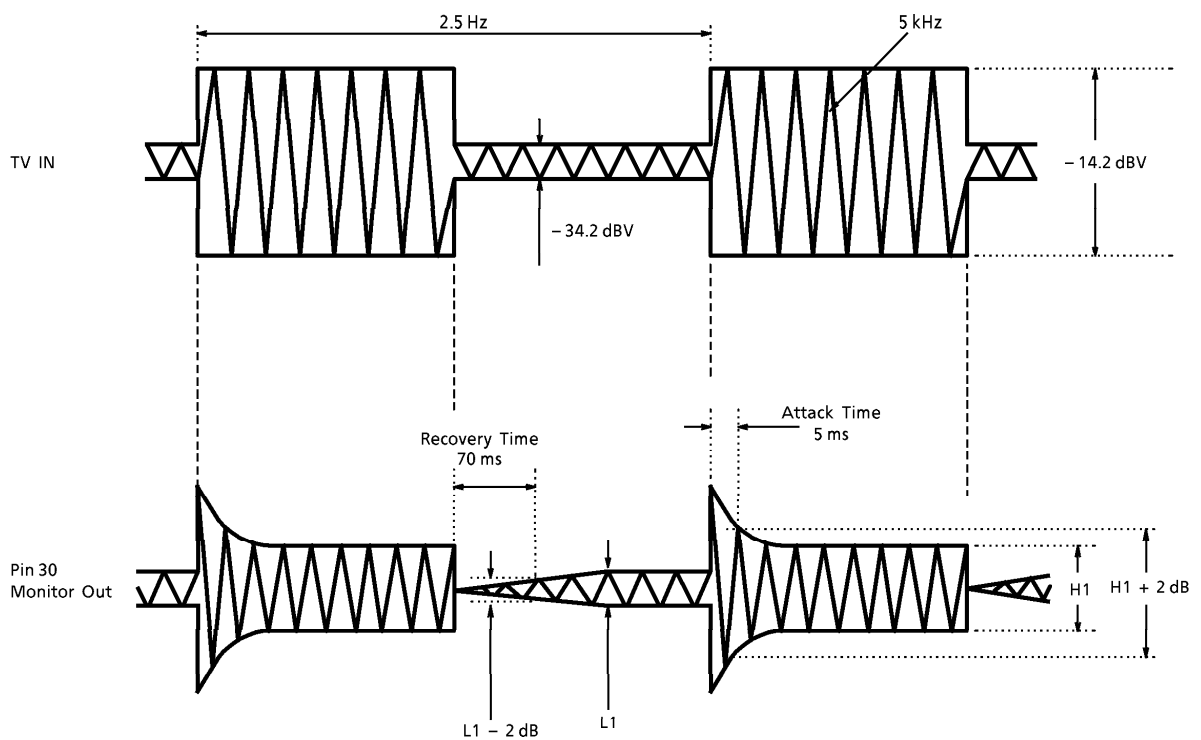

(Remark 9) 20 kHz LPF (Only for reference : This characteristic cannot be measured at any terminal.)

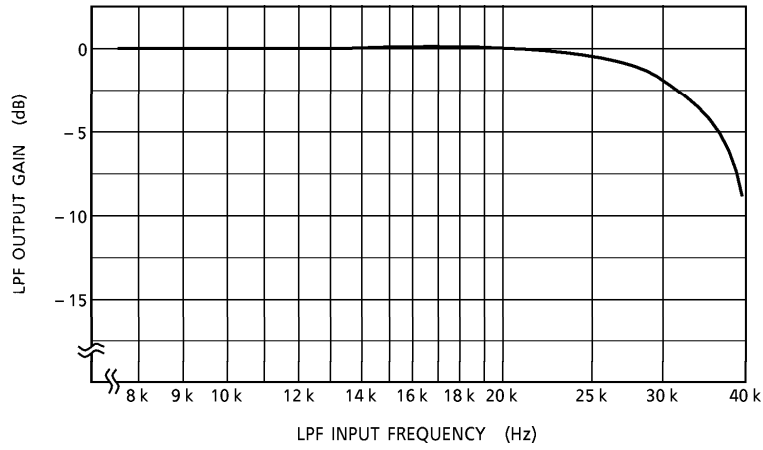

(Remark 10) Monaural out (to RF conv.) ALC characteristic

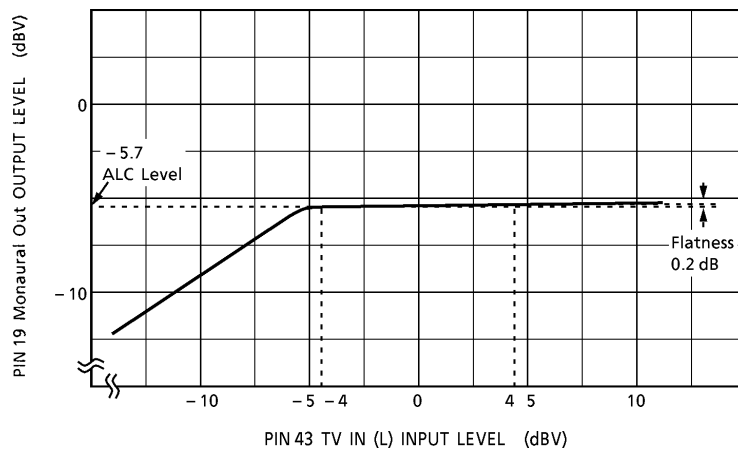

(Remark 11) Features of BPF characteristic

- Gain characteristic . . . to have notch characteristic in order to prevent FM signals from other channels
- Group delay to flatten group delay characteristic in order to prevent strain inferiority.

BPF Automatic Adjustment

This IC automatically adjusts the BPF characteristic with 6 bit resolution using bus line clock at start-up. So, it can always keep stable characteristics.

- Supplements ① It needs clock pulses to adjust the BPF characteristic.
(clock frequency of less than 200 kHz, maximum 512 pulses)
There is no problem to send data during automatic adjust, but pay attention as not to set the BPF Request Mode "ON" again (SA No. 1, D5). The adjustment works independently respectively by L-ch and R-ch and ends automatically.
- ② Re-adjust the BPF characteristic with "BPF Request mode" after start-up at use.
BPF Request mode : SA No. 1, D5. We recommend this mode to used every time at play-back (just before play-back).

(Caution)

Do not automatic adjust in the state of power supply transition and the state of unstably. And do not send the clock pulse or the data pulse in the state of power supply transition.

Usage of automatic adjustment (Setup procedure)

1. Usage at every normal start-up

- (1) Since automatic adjustment starts as soon as pin 2 (V_{ref}) voltage exceeds $7/18 V$ (V_{CC} H), automatic adjustment will be executed by inputting clock pulses at that time.
(It is not particularly necessary the Bus line data.)

2. Usage after start-up

- (1) Automatic adjustment starts with the BPF Request mode "ON" (SA No. 1, D5)
- (2) Set the BPF request mode "OFF".
And the adjustment is executed by inputting the clock pulses.

Supplements :

- ① If the BPF request mode "ON", the adjustment definitely starts from the initial state.
- ② BPF Request can set up in any of Rec and PB mode, but pay attention that modulator an demodulator atop at adjust mode.
- ③ We recommend the automatic adjust should be executed at start-up or just before play-back.

BPF frequency characteristic.

Supplement ... In this IC, BPF f_0 and Mod. f_0 are automatically shifted by choosing NTSC or PAL with Bus line.

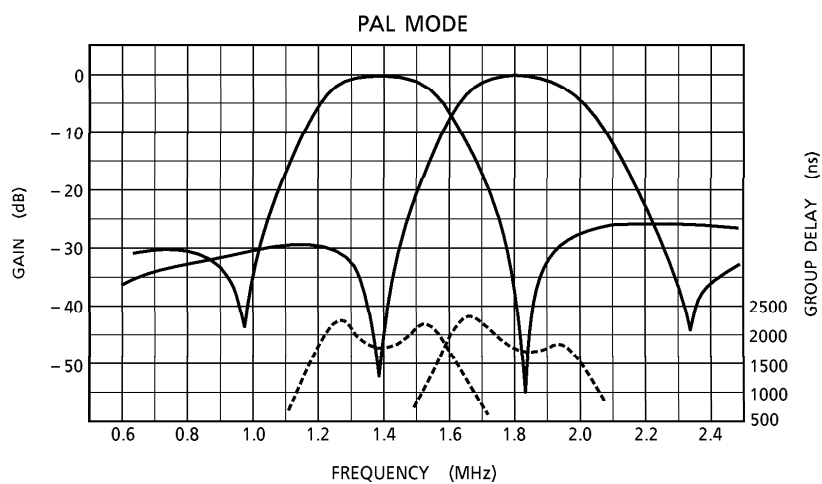
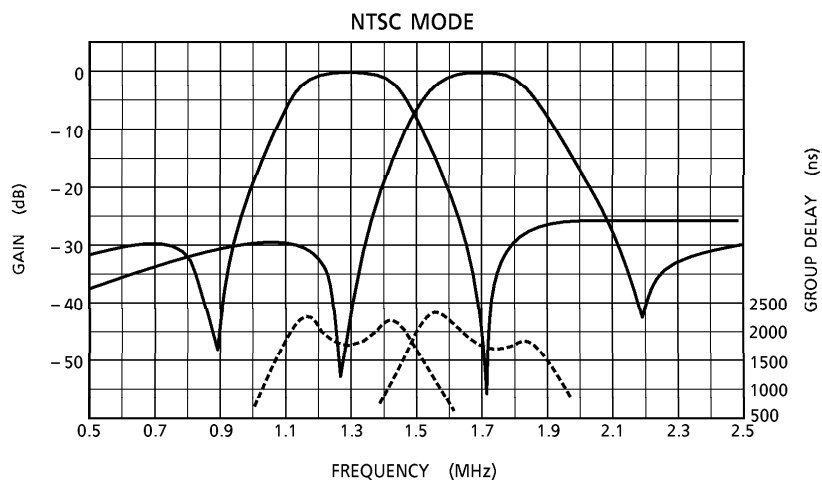

(Remark 12) Characteristic of level meter log amp.

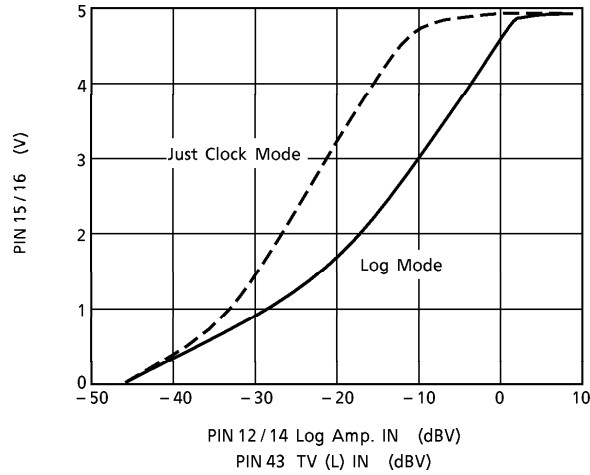

(Remark 13) Characteristic of envelope det. out

PB FM IN is Mix IN of L and R, but the characteristics as follows illustrate as either channel of L or R.

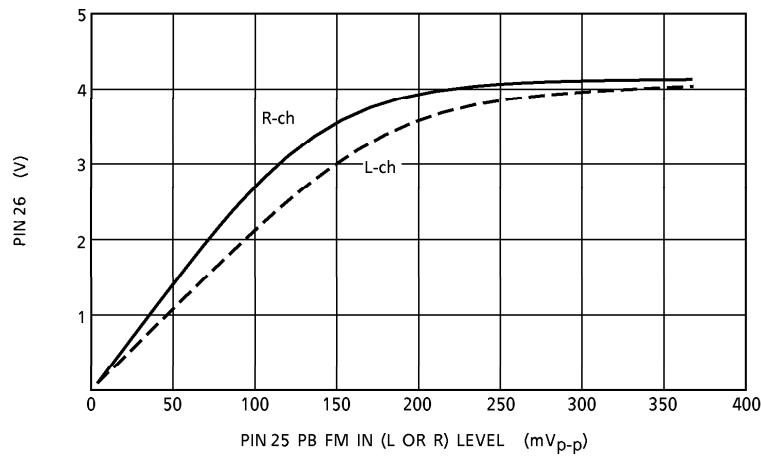

(Remark 14) PB FM drop out

Outline of this function

DOC (Drop-Out Compensation)

This IC detects "Dropout" when the PB FM signal is missed for $4 \mu s$ or more and the dropout compensation works shortest between $18 \mu s$.

We call this dropout compensation "Smoothing Mute" and this corrects play-back audio signal.

In the compensation, the electric potential is smoothly brought close from the dropout detection point toward the V_{ref} .

Fig.1 shows the waveform of the dropout detection timing and the DOC operation.

Supplement The audio outputs does not turn to Normal Audio when the dropout is detected.

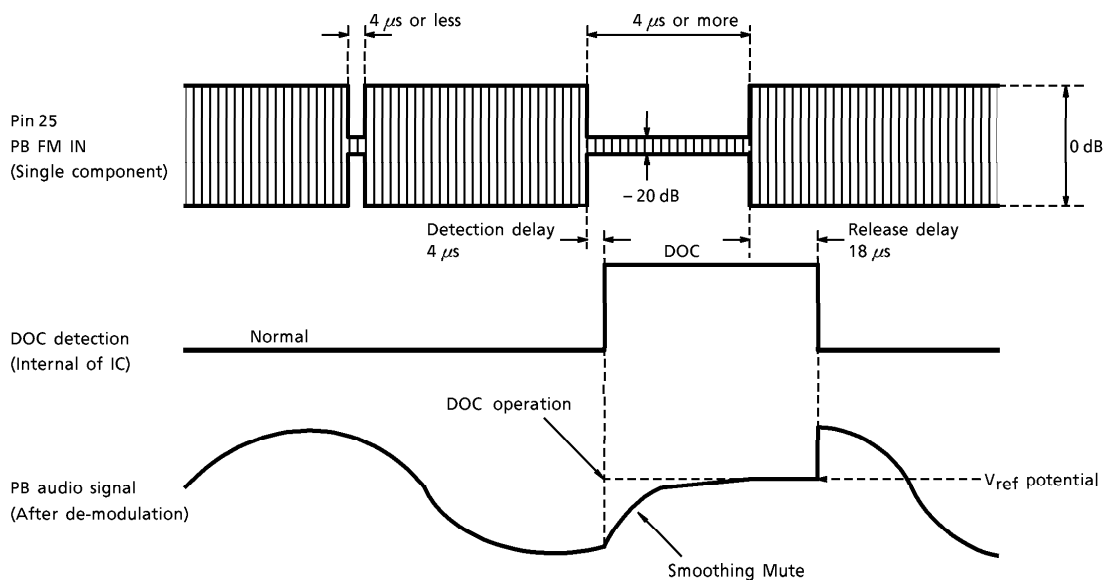

Fig.1

Even if PB FM Level changes somewhat, 0 dB which becomes the reference of detection is constantly controlled with AGC because dropout is detected by the following PB FM AGC signal.

The response time of AGC is set much longer than the dropout time. Therefore, the dropout is not lifted up in AGC.

Fig.2 shows the dropout detection level, the PB FM Level movement and the appearance of the control of AGC.

Supplement The dropout detection level is -20 dB. The hysteresis of 6 dB is applied to release level. (Refer to the following figure.)

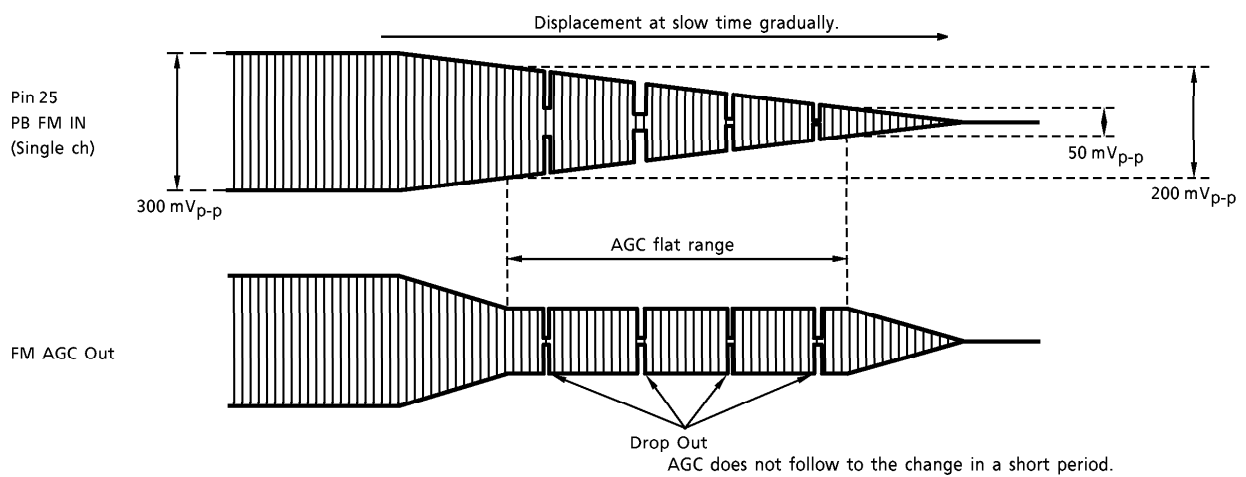

Fig.2

(Remark 15) PB FM mute (Non Hi-Fi detection)

Outline of this function

Mute

When the dropout of the PB FM signal detects and 340 μs of more continues, this IC detects Non Hi-Fi.

Release of Non Hi-Fi detection is after 3.3 ms after the dropout is released.

If Non Hi-Fi is detected, the Hi-Fi processing part is muted and audio outputs turn to Normal Audio.

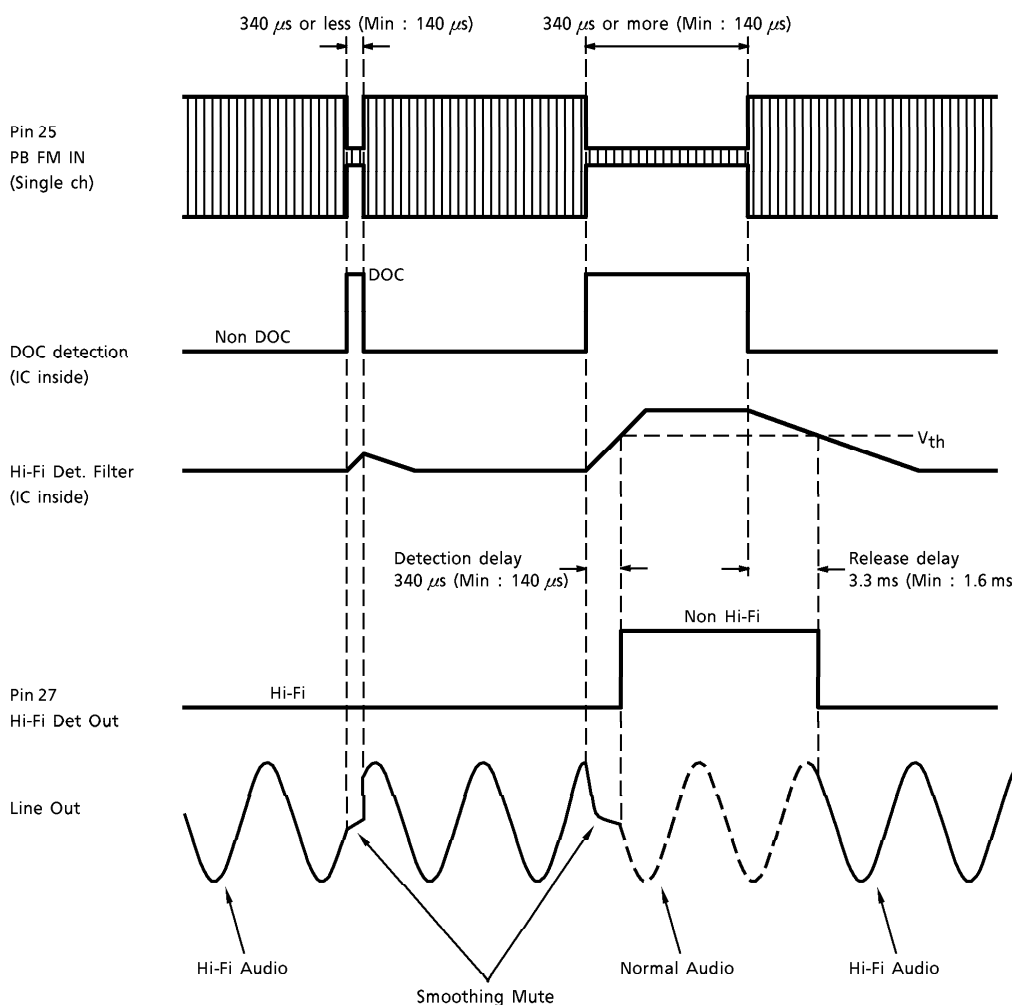

Fig.3

The detection delay and the release delay time of Non Hi-Fi are set by the constant in the IC.

(Note) Please set Mute with the bus at a special reproduction etc. because PB FM Level is unstable and the Non Hi-Fi detection is unstable at that time, too.

(Remark 16) Procedure of test mode

This IC has three test modes for the evaluation. To enter the various test modes, the forced voltage is impressed from the outside to the terminal. The procedure to enter the test modes is shown as follows.

1. FM mod out (Pin 22) : L-ch / R-ch selection

(1) Initial state : The forced voltage is not impressed to any terminal.

(Especially, please make terminal 31 (Norm IN) "Open". Because the signal is output from pin 30 when pin 31 is in the state "GND".)

(2) Bus setting : Rec mode (The FM modulation signal is output.)

(3) Impress the voltage to pin 31.

5 V : L-ch FM Out (NTSC : 1.3 MHz, PAL : 1.4 MHz)

GND : R-ch FM Out (NTSC : 1.7 MHz, PAL : 1.8 MHz)

2. Rec PNR out / PB SW N.C. out monitor (pin 30) : Monitor ON and L-ch / R-ch selection

(1) Initial state

(2) Bus setting : EE, Rec of PB (Any mode possible)

(3) Pin 31

GND : Monitor ON (L-ch monitoring at pin 30)

(4) Pin 27 (Hi-Fi Det Out)

9 V : R-ch selected

3. PB BPF monitor

The BPF characteristic can be evaluated as following procedure.

Signal route : pin 25 (PB FM IN)→BPF→pin 22 (Rec FM Out)

(1) Initial state

(2) Bus : PB mode

(3) Impress the voltage to pin 27.

9 V : BPF Monitor Mode ON

(4) In the above-mentioned condition, L-ch or R-ch is selected with Bus control "FM AGC : L-ch or R-ch" (SA No.2 D₂). In addition, L-ch or R-ch can be selected from the outside according to procedure 5).

SA No.2 D₂ "0" : R-ch BPF Monitor Out

"1" : L-ch BPF Monitor Out

(5) Impress the voltage to pin 31. (The bus control of procedure 4) is not accepted.)

9 V : R-ch BPF Monitor Out

GND : L-ch BPF Monitor Out

Supplement : Input level

Pin 25 (PB FM IN) : 25 mV_{p-p} (CM Sin Wave)

Pin 24 (FM AGC Filter) : DC 1.0 V

(Remark 17) Method of using log amp. for just clock

We recommend that Log Amp. of this IC is used as DC converter for the Just Clock function. The Just Clock is a useful function that adjust the clock of VCR by micro computer with the time signal of the TV broadcasting.

■ Just Clock mode procedure :

- (1) Aux Mute ON. Bus Mute Off.
- (2) Just Clock is ON by Bus control (SA No.0 D7 : "1"). Then Log Amp. input SW turns to "B" as shown in the following figure. (Only L-ch of Log Amp. operates at the Just Clock mode.)

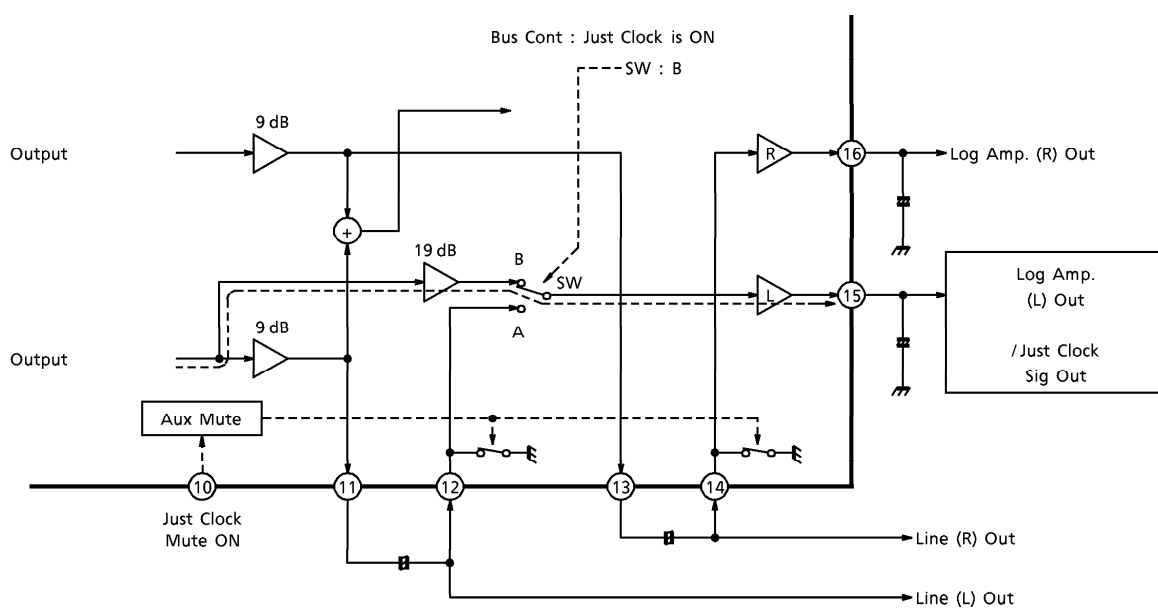

Level chart

Normal

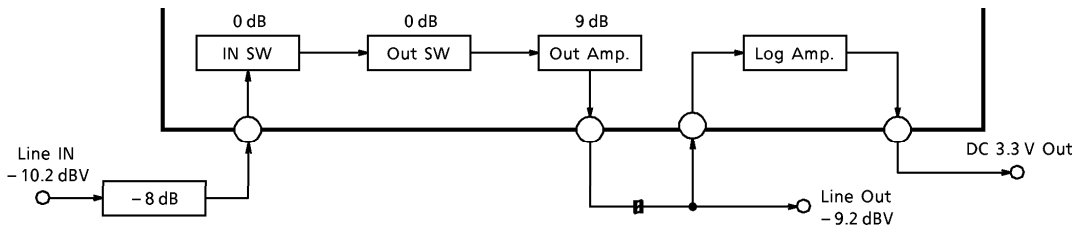

Just clock

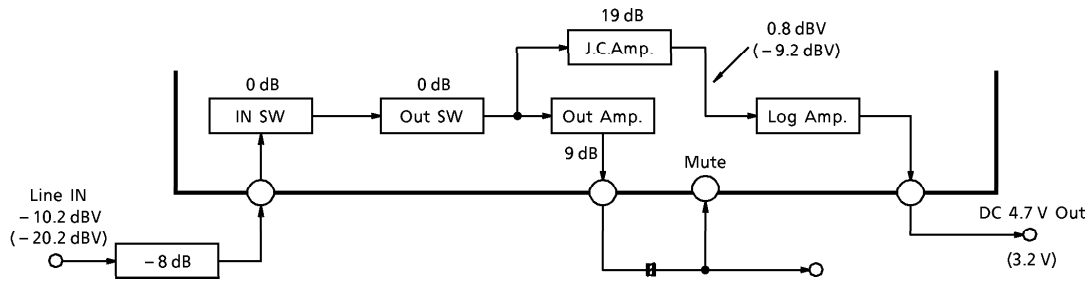

(Remark 18) FM mod. out temperature characteristics

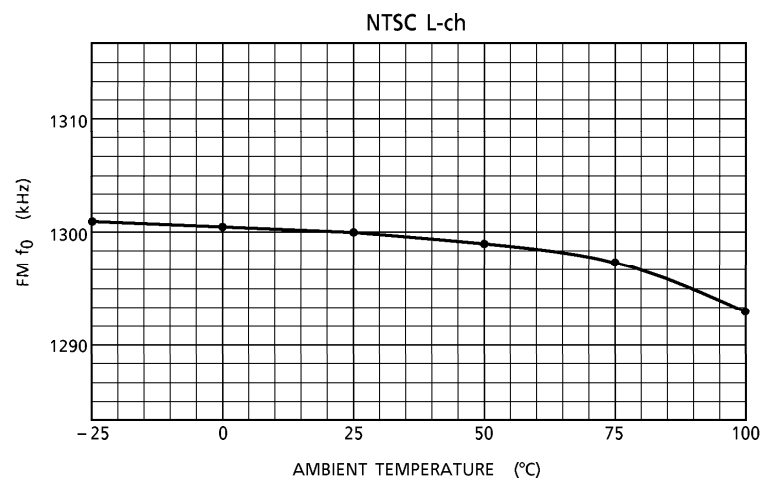
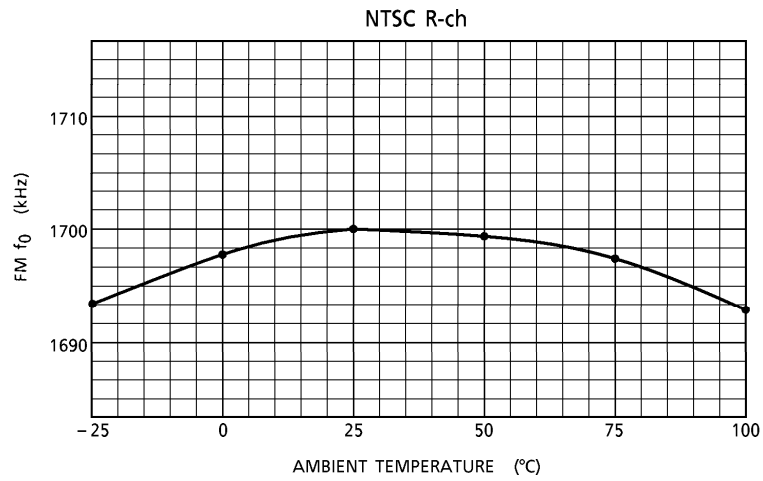

(Remark 19) FM mod. out supply voltage characteristics

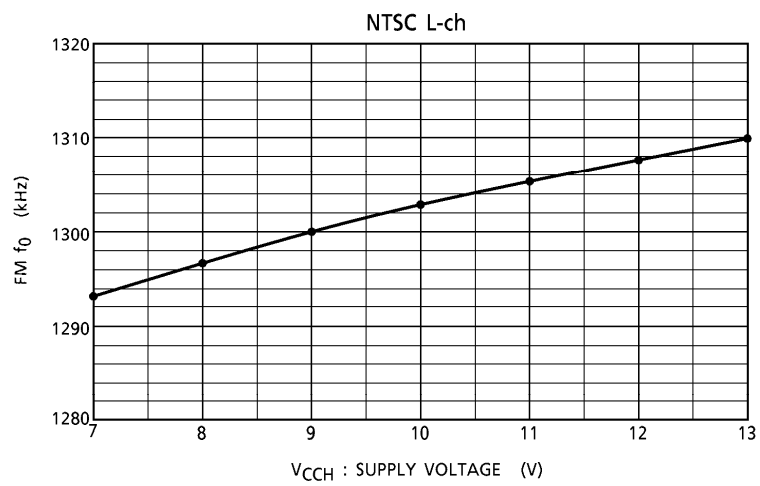
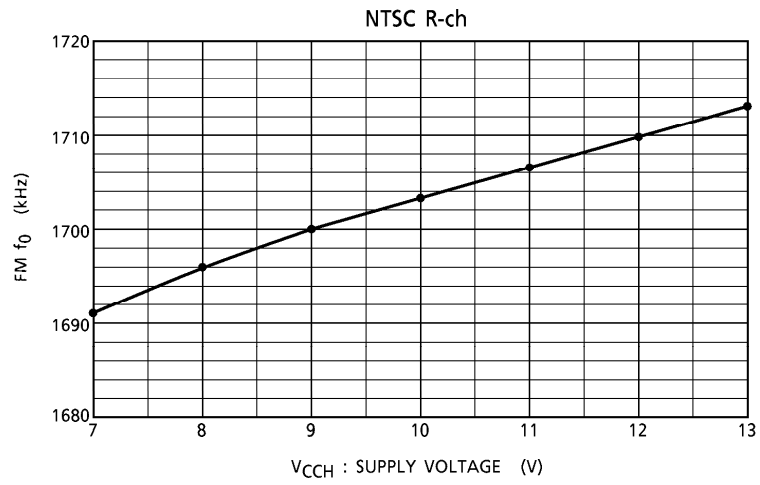

OPERATING CONDITION

Operating voltage range : 4.75 V~5.25 V, 8.75 V~9.25 V
 Typ. supply voltage : 5.0 V (FM circuit), 9.0 V (Audio circuit)
 Supply current : Rec mode 14 mA (V_{CC} 5 V) + 24 mA (V_{CC} 9 V) = 286 mW
 PB mode 21 mA (V_{CC} 5 V) + 26 mA (V_{CC} 9 V) = 339 mW

MAXIMUM RATINGS (Ta = 25°C)

CHARACTERISTIC	SYMBOL	RATING	UNIT
Supply Voltage	V_{CC}	10	V
Input Terminal Voltage	v_{IN}	$V_{EE} - 0.3 \sim V_{CC} + 0.3$	V
Input Signal Voltage	e_{IN}	9	V_{p-p}
Power Dissipation	P_D (Note)	962	mW
Operating Temperature	T_{opr}	- 20~75	°C
Storage Temperature	T_{stg}	- 55~150	°C

THE THERMAL RESISTANCE CHARACTER-
 ISTIC OF THE PACKAGE : QFP48-P-1014-0.80

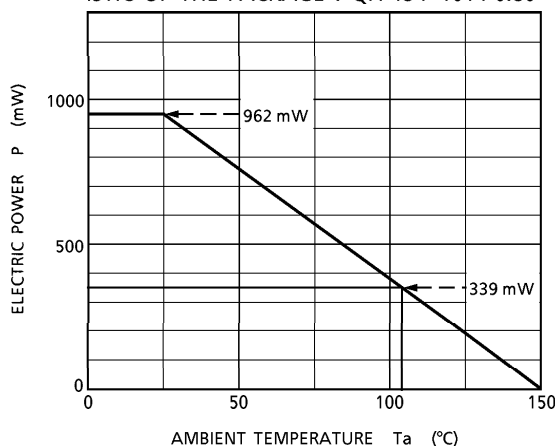

ATTENTION IN USE

- (1) Please do not start up the power supply of the IC while inputting the Bus control signal. Please input the Bus control signal after standing up of the power supply.
- (2) Please do not start up the power supply after applying the forced voltage to the terminals such as pin 31 though it enters the test mode for the evaluation by applying the forced voltage.

ELECTRICAL CHARACTERISTICS (V_{CC} high = 9 V, V_{CC} low = 5 V, T_a = 25°C)

CHARACTERISTICS		SYMBOL	TEST CIRCUIT	TEST CONDITION			MIN.	TYP.	MAX.	UNIT
Bl. No.	ITEM			TEST TERMINAL	MAIN-MODE	THE OTHERS				
V _{CC}	1-1	Supply Current	—	—	Supply current at Rec mode.	9 V	24	29	mA	
	1-2					Supply current at PB mode.	5 V	14		18
Input-Output Selector EE Circuit	2-1	GTV	—	TV IN 43, 41 → Line Out 11, 13	1. γ_{IN} (TV IN) : 1 kHz, -10.2 dBV 2. Measure : γ_{OUT} (Line Out)	19	21	26		
	2-2	GL1	—	Line.1 IN 47, 45 → Line Out 11, 13	1. γ_{IN} (Line.1 IN) : 1 kHz, -10.2 dBV 2. Measure : γ_{OUT} (Line Out)					
	2-3	GL2	—	Line.2 IN 39, 38 → Line Out 11, 13	1. γ_{IN} (Line.2 IN) : 1 kHz, -10.2 dBV 2. Measure : γ_{OUT} (Line Out)	0.5	1.0	1.5	dB	
	2-4	GL3	—	Line.3 IN 5, 1 → Line Out 11, 13	1. γ_{IN} (Line.3 IN) : 1 kHz, -10.2 dBV 2. Measure : γ_{OUT} (Line Out)					
	2-5	DTV (Design Grantee)	—	TV IN 43, 41 → Line Out 11, 13	1. γ_{IN} (TV IN) : 1 kHz, -10.2 dBV 2. Measure distortion : γ_{OUT} (Line Out)	—	0.01	0.03	%	
	2-6	TV Out Max Level	—	TV IN 43, 41 → Line Out 11, 13	1. γ_{IN} (TV IN) : 1 kHz, level up 2. Measure : γ_{OUT} (Line Out) at THD 1%.	7.6	8.6	—	dBV	

BI.	CHARACTERISTICS		SYMBOL	TEST CIR-CUIT	TEST CONDITION			MIN.	TYP.	MAX.	UNIT
	No.	ITEM			TEST TERMINAL	MAIN-MODE	THE OTHERS				
Input-Output Selector EE Circuit	2-7	Line.2 Monitor Gain	GL2 Moni	—	Line.2 IN 39, 38 → Line Out 11, 13	Out SW : Monitor	1. V_{IN} (Line.2 IN) : 1 kHz, -10.2 dBV 2. Measure : V_{OUT} (Line Out)	0.5	1.0	1.5	dB
	2-8	Line.3 Monitor Gain	GL3 Moni	—	Line.3 IN 5, 1 → Line Out 11, 13		1. V_{IN} (Line.3 IN) : 1 kHz, -10.2 dBV 2. Measure : V_{OUT} (Line Out)				
	2-9	N.A. Out Mix Gain (H. L/R Mix)	GH.N Mix1	—	TV IN 43, 41 → N.A. Out 35	IN SW : TV (L + R)	1. V_{IN} (TV IN) : 1 kHz, level up 2. Measure : V_{OUT} (Norm. Audio Out)		0	1.0	dB
	2-10	N.A. Out Dual Gain	GDu	—	TV IN 43 → N.A. Out 35	IN SW : TV (L) Dual mode	1. V_{IN} (TV IN) : 1 kHz, level up 2. Measure : V_{OUT} (Norm. Audio Out)	-0.5			
	2-11	N.A. Line.3 (SAP) Out Gain	GSAP	—	Line.3 IN 5 → N.A. Out 35	IN SW : Line3.L	1. V_{IN} (Line.3) : 1 kHz, -10.2 dBV 2. Measure : V_{OUT} (Norm. Audio Out)	-0.5	0.0	0.5	dB
	2-12	Norm Audio Out Max Level	$V_{N.Max}$	—	Line.3 IN 5 → N.A. Out 35	IN SW : Line3.L	1. V_{IN} (Line.3) : 1 kHz, level up 2. Measure : V_{OUT} (Norm. Audio Out) at THD 1%.	7.6	8.6	—	
	2-13	Norm Audio Distortion (Design Grantee)	DN	—			1. V_{IN} (Line.3) : 1 kHz, -10.2 dBV 2. Measure distortion : V_{OUT} (Norm. Audio Out)	—	0.01	0.03	dBV

TA1246F/AF-47

CHARACTERISTICS		SYMBOL	TEST CIRCUIT	TEST CONDITION			MIN.	TYP.	MAX.	UNIT
Bl. No.	ITEM			TEST TERMINAL	MAIN-MODE	THE OTHERS				
2-14	Norm IN Gain	GN.IN	Norm Audio Output SW IN 31 → Line Out 11, 13	-	1. V_{IN} (N.A.O.SW IN) : 1 kHz, -10.2 dBV 2. Measure : V_{OUT} (Line Out) (*) Output select : "Normal" mode	1.5	2.0	2.5	dB	
	Norm IN Max Out Level	$V_{N.IN}$ Max				5.4	6.0	-		
2-16	Norm IN + Hi-Fi Mix Gain.1	GN.IN Mix1	Norm Audio Output SW IN 31 & TV IN 43, 41 → Line Out 11, 13	-	1. V_{IN1} (N.A.O.SW IN) : 1 kHz, -10.2 dBV 2. V_{IN2} (TV IN) : No input 3. Measure : V_{OUT} (Line Out) (*) Output select : "Hi-Fi + Normal" mode	-4.5	-4.0	-3.5	dB	
	Norm IN + Hi-Fi Mix Gain.2	GN.IN Mix2				-5.5	-5.0	-4.5		
2-18	Norm IN + Hi-Fi Mix Gain.3	GN.IN Mix3	-	-	1. V_{IN1} (N.A.O.SW IN) : 1 kHz, -10.2 dBV 2. V_{IN2} (TV IN) : 1 kHz, -10.2 dBV 3. V_{OUT} (Line Out) (*) Output select : "Hi-Fi + Normal" mode	1.0	1.5	2.0	dB	

Input-Output Selector EE Circuit

BI.	CHARACTERISTICS		SYMBOL	TEST CIR-CUIT	TEST CONDITION			MIN.	TYP.	MAX.	UNIT			
	No.	ITEM			TEST TERMINAL	MAIN-MODE	THE OTHERS							
EVR	3-1	EVR Gain	GEVR	-	TV IN 43, 41 → Line Out 11, 13	EVR : Manual EVR DC 1.8V	1. VIN (TV IN) : 1 kHz, -10.2 dBV	0.0	1.0	2.0	dB			
							2. EVR Vol. DC : 1.8V (Gain Typ.)							
							3. VOUT (Line Out)							
	3-2	EVR Gain L/R Ratio	ΔGEVR				1. 3-1 : VOUT (Line Out)					-1.0	0.0	1.0
							Measure the difference at the level of L-ch and R-ch.							
	3-3	EVR Max Gain	GEVR Max				1. VIN (TV IN) : 1 kHz, -20.2 dBV					14.0	15.0	16.0
							2. EVR Vol. DC : 4.5V (Gain Max)							
							3. VOUT (Line Out)							
	3-4	EVR Min Gain	GEVR Min				1. VIN (TV IN) : 1 kHz, -0.2 dBV					-	-80	-70
							2. EVR Vol. DC : 0V (Gain Min)							
							3. VOUT (Line Out)							
3-5	EVR Distortion.1	DEVR.1	1. VIN (TV IN) : 1 kHz, -10.2 dBV	-	0.03	0.10								
			2. EVR Vol. DC : 1.8V (Gain Typ.)											
			3. Measure distortion : VOUT (Line Out)											
3-6	EVR Distortion.2	DEVR.2	1. VIN (TV IN) : 1 kHz, -0.2 dBV	-	0.07	0.20								
			2. EVR Vol. DC : 1.8V (Gain Typ.)											
			3. Measure distortion : VOUT (Line Out)											
3-7	EVR Out Max Level	VEVR Max	1. VIN (TV IN) : 1 kHz level up	7.6	8.6	-								
			2. EVR Vol. DC : 1.8V (Gain Typ.)											
			3. Measure : VOUT (Line Out) at THD 1%.											
3-8	EVR ALC Gain	GEVR Max	1. VIN (TV IN) : 1 kHz, -10.2 dBV	0.0	1.0	2.0								
			2. VOUT (Line Out)											
3-9	EVR ALC Gain L/R Ratio	ΔGALC L/R	1. VIN (TV IN) : 1 kHz, -10.2 dBV	-1.0	0	1.0								
			2. VOUT (Line Out)											
3-10	EVR ALC Level	VEVR ALC	Measure the difference at the level of L-ch and R-ch.	-4.6	-3.6	-2.6								
			1. VIN (TV IN) : 1 kHz, -2 dBV											
3-11	EVR ALC Flatness	FEVR ALC	1. VIN (TV IN) : 1 kHz, -2/6 dBV	0	0.6	1.2								
			2. VOUT (Line Out)											
			Input two kinds of signals and measure the difference of the outputs.											

TA1246F/AF-49

CHARACTERISTICS		SYMBOL	TEST CIRCUIT	TEST CONDITION			MIN.	TYP.	MAX.	UNIT
Bl. No.	ITEM			TEST TERMINAL	MAIN-MODE	THE OTHERS				
3-12	Input Impedance	R _{IN}	—	TV IN Line IN	—	1. Measure the resistance of the input terminal. Pin : 1, 5, 38, 39, 41, 43, 45, 47	96	120	144	kΩ
4-1	Monaural Out Gain	G _{Mono}	—	TV IN 43, 41 → Mono Out 19	Out SW Hi-Fi (L + R)	1. V _{IN} (TV IN) : 1 kHz, -10.2 dBV 2. V _{OUT} (Monaural Out)	0	1.2	2.4	dB
4-2	Monaural Out Distortion.1 (Design Grantee)	D _{Mono1}	—	TV L. IN 43 → Mono Out 19	Out SW Hi-Fi (L)	1. V _{IN} (TV L IN) : 1 kHz, -10.2 dBV 2. Measure distortion : V _{OUT} (Monaural Out)	—	0.05	0.20	%
4-3	Monaural Out Distortion.2 (Design Grantee)	D _{Mono2}				1. V _{IN} (TV L IN) : 1 kHz, -0.2 dBV 2. Measure distortion : V _{OUT} (Monaural Out)	—	0.06	0.20	
4-4	Monaural Out Max Level	V _{Mono Max}	—	TV L. IN 43 → Mono Out 19	Out SW Hi-Fi (L)	1. V _{IN} (TV L IN) : 1 kHz, level up 2. Pin 21 (Mono ALC Filter) : GND 3. Measure : V _{OUT} (Monaural Out) at THD 1%.	6.5	7.5	—	dB
4-5	Monaural Out ALC Level	V _{Mono ALC}	—			1. V _{IN} (TV L IN) : 1 kHz, -4 dBV 2. V _{OUT} (Monaural Out)	—	—	—	—
4-6	Monaural Out ALC Flatness	ΔG _{Mono ALC}	—	—	—	1. V _{IN} (TV L IN) : 1 kHz, -4 / 4 dBV 2. V _{OUT} (Monaural Out) Input two kinds of signals and measure the difference of the output at time.	0	0.4	1.5	dB

TA1246F / AF-50

CHARACTERISTICS		SYMBOL	TEST CIRCUIT	TEST CONDITION			MIN.	TYP.	MAX.	UNIT	
Bl. No.	ITEM			TEST TERMINAL	MAIN-MODE	THE OTHERS					
Log Amp.	5-1	Log Amp Out.1 V _{Log1}	—	Log Amp IN 12, 14 → Log Amp Out 15, 16	EE NTSC	1. γ IN (Log Amp IN) : No input 2. Measure DC (V) : γ OUT (Log Amp Out)	—	0.05	0.20	V	
	5-2	Log Amp Out.2 V _{Log2}					1. γ IN (Log Amp IN) : 1 kHz, -29.2 dBV 2. Measure DC (V) : γ OUT (Log Amp Out)	0.75	0.9		1.1
								5-3	Log Amp Out.3 V _{Log3}		1. γ IN (Log Amp IN) : 1 kHz, -9.2 dBV 2. Measure DC (V) : γ OUT (Log Amp Out)
	5-4	Log Amp Out.4 V _{Log4}					1. γ IN (TV L IN) : 1 kHz, -20.2 dBV 2. Measure DC (V) : γ OUT (Log Amp L Out)				
								5-5	Log Amp Out.5 V _{Log5}		Just Clock ON Aux Mute ON

TA1246F/AF-51

Bl.	CHARACTERISTICS		SYMBOL	TEST CIRCUIT	TEST TERMINAL	TEST CONDITION		MIN.	TYP.	MAX.	UNIT
	No.	ITEM				MAIN·MODE	THE OTHERS				
6-1	Aux Mute ON Threshold Voltage	V _{th10}	—	Aux Mute Cont 10	EE NTSC	1. TV L IN → Line Out : Monitor (Confirm the output (Line Out) signal.) 2. Raise the voltage of pin 10 from 0 (V). Measure the voltage of pin 10 when the signal of Line Out goes out.		1.0	1.2	(5.0)	V
						6-2	BPF Monitor ON Threshold Voltage				

Ext. Cont.

CHARACTERISTICS		SYMBOL	TEST CIRCUIT	TEST CONDITION			MIN.	TYP.	MAX.	UNIT
Bl. No.	ITEM			TEST TERMINAL	MAIN-MODE	THE OTHERS				
6-3	PNR Monitor R-ch ON Threshold Voltage	V _{th27R}	—	Pin 30 R-ch Monitor 27		1. Pin 31 (Norm IN) : GND Pin 30 Monitor Out mode 2. V _{IN} (TV R IN) : 1 kHz, -10.2 dBV 3. Line Out : R-ch EE mode 4. Pin 27 : DC (V) 5. V _{OUT} (Pin 30) Monitor Raise the voltage of pin 27 from 0 (V). Measure the voltage of pin 27 when the signal of pin 30 goes out.	6.0	6.3	(9.0)	V
				TV R IN 41 → Rec PNR Monitor 30						
				Rec FM L/R SW 30						
6-4	Rec FM Out L-ch Monitor Threshold Voltage	V _{th30L}	—	TV IN No Input → Rec FM Out 22 (No Moduration)	Rec NTSC	1. Pin 31 (Norm IN) : Open Pin 30 Cont mode 2. V _{IN} : No input 3. V _{OUT} : Pin 22 (Rec FM Out) Monitor. (State of L/R Mix) 4. Pin 30 : DC (V) 5. Raise the voltage of pin 30 from 2.5 (V). Measure the voltage of pin 30 when the signal of pin 22 changes into L-ch.	3.8	4.1	5.0	V
				Rec FM L/R SW 30						
				TV IN No Input → Rec FM Out 22 (No Moduration)						
6-5	Rec FM Out R-ch Monitor Threshold Voltage	V _{th30R}	—	Rec FM L/R SW 30		1. Pin 31 (Norm IN) : Open Pin 30 Cont mode 2. V _{IN} : No input 3. V _{OUT} : Pin 22 (Rec FM Out) Monitor. (State of L/R Mix) 4. Pin 30 : DC (V) 5. Reduce the voltage of pin 30 from 2.5 (V). Measure the voltage of pin 30 when the signal of pin 22 changes into R-ch.	(0)	1.3	1.6	V
				TV IN No Input → Rec FM Out 22 (No Moduration)						
				Rec FM L/R SW 30						



Ext. Cont.

BI.	CHARACTERISTICS		SYMBOL	TEST CIRCUIT	TEST CONDITION			MIN.	TYP.	MAX.	UNIT
	No.	ITEM			TEST TERMINAL	MAIN-MODE	THE OTHERS				
6-6	BPF L-ch Monitor Threshold Voltage	Vth31L	—	BPF L/R SW 31 PB FM IN 25 → Rec FM Out 22	PB		1. VIN (PB FM IN) : 1.3 MHz, 25 mV _{p-p}	(0)	1.3	1.6	
							2. Pin 24 (FM AGC Filter) : DC 1V				
							3. Pin 27 (BPF Moni) : DC 9V BPF Monitor mode				
6-7	BPF R-ch Monitor Threshold Voltage	Vth31R	—	BPF L/R SW 31 PB FM IN 25 → Rec FM Out 22	NTSC		1. VIN (PB FM IN) : 1.7 MHz, 25 mV _{p-p}	7.4	7.7	(9.0)	V
							2. Pin 24 (FM AGC Filter) : DC 1V				
							3. Pin 27 (BPF Moni) : DC 9V BPF Monitor mode				
6-8	PNR Monitor ON Threshold Voltage	Vth31M	—	Cont/Moni SW 31 TV IN 41, 43 → 30 Monitor	EE NTSC		1. VIN (TV IN) : 1 kHz, -10.2 dBV	(0)	1.4	1.6	
							2. Line Out : EE mode				
							3. Pin 31 (Norm IN) : DC (V) 4. VOUT (Pin 30) Monitor Reduce the voltage of Pin 31 from 4.5 (V). Measure the voltage of pin 31 when the signal of pin 30 goes out.				

Ext. Cont.

Bl. No.	CHARACTERISTICS		SYMBOL	TEST CIR-CUIT	TEST TERMINAL	TEST CONDITION		MIN.	TYP.	MAX.	UNIT
	ITEM	TEST MAIN-MODE				THE OTHERS					
PNR (Req)	7-1	Encode Level	V _{Enco}	—	TV IN 41, 43 → Monitor Out 30	EE NTSC	1. V _{IN} (TV IN) : 400 Hz, -10.2 dBV 2. Pin 31 : GND 3. Pin 27 : Open (L-ch) & 9 V (R-ch) 4. V _{OUT} : Pin 30 (Monitor Out) Monitor (Note) It is necessary to connect with buffer (Voltage follower) for measuring pin 30.	-10.5	-9.5	-8.5	dBV
	7-2	Encode Level L/R Ratio	ΔV_{Enco} L/R				1. 7-1 : V _{OUT} (Line Out) Measure the difference at the level of L-ch and R-ch.	-0.5	0	0.5	dB
	7-3	Encode Compress	L _{Enco}				1. V _{IN} (TV IN) : 400 Hz, -10.2 / -50.2 dBV 2. V _{OUT} (Monitor Out) Monitor Input two kinds of signals and measure the difference of the outputs.	17.0	18.5	20.0	
	7-4	Encode Distortion (Design Grantee)	D _{Enco}				1. V _{IN} (TV IN) : 1 kHz, -10.2 dBV 2. Measure distortion V _{OUT} (Monitor Out) Monitor	—	0.1	0.2	%
	7-5	Encode Out Max Level	ΔV_{Enco} Max				1. V _{IN} (TV IN) : 1 kHz, level up 2. Measure : V _{OUT} (Monitor Out) Monitor at THD 2%.	-0.7	1.3	—	dBV

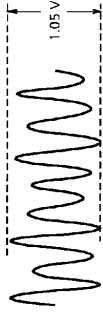
TA1246F / AF-55

CHARACTERISTICS		SYMBOL	TEST CIRCUIT	TEST CONDITION			MIN.	TYP.	MAX.	UNIT
Bl. No.	ITEM			TEST TERMINAL	MAIN-MODE	THE OTHERS				
FM Mod (Rec)										
8-1	Mod Out Level	V ₃₄ Mod			1. V _{IN} (TV IN) : No Input 2. Measure V _{OUT} Pin 22 (FM Out)	0.95	1.05	1.15	V _{p-p}	
										
8-2	f ₀ (L) Center Frequency (NTSC)	f _{0.L} NTSC		Rec NTSC	1. V _{IN} (TV IN) : No input 2. V _{OUT} Pin 22 (FM Out) 3. L/R of the FM output is switched with pin 30.	1.295	1.300	1.305	MHz	
8-3	f ₀ (R) Center Frequency (NTSC)	f _{0.R} NTSC			Pin 30 5V : L-ch Out GND : R-ch Out	1.695	1.700	1.705		
8-4	f ₀ (L) Center Frequency (PAL)	f _{0.L} PAL		Rec		1.395	1.400	1.405	MHz	
8-5	f ₀ (R) Center Frequency (PAL)	f _{0.R} PAL		PAL		1.795	1.800	1.805		
8-6	FM Out L/R Mix Ratio.1	RMix.1		SA No.2 D7 D6 0 0	1. Rec NTSC mode 2. V _{IN} (TV IN) : No input 3. V _{OUT} (FM Out) 4. The Mix ratio of the FM output is controlled with Bus.	5.7	7.7	9.7	dB	
8-7	FM Out L/R Mix Ratio.2	RMix.2		SA No.2 D7 D6 0 1		8.5	10.0	11.5		
8-8	FM Out L/R Mix Ratio.3	RMix.3		SA No.2 D7 D6 1 0		10	12	14		
8-9	FM Out L/R Mix Ratio.4	RMix.4		SA No.2 D7 D6 1 1		12.5	15.0	17.5		
8-10	Deviation	DevMod		Rec NTSC	1. V _{IN} : DC ±0.5V 2. V _{OUT} (FM Out) Measure the frequency of the FM output at ±0.5V movement.	(TA1246F) 49.5	53.0	56.5	kHz	
					Dev L/R 4, 36 → FM Out 22	(TA1246AF) 45.5	49.0	52.5		

Bl.	CHARACTERISTICS		SYMBOL	TEST CIRCUIT	TEST CONDITION			MIN.	TYP.	MAX.	UNIT
	No.	ITEM			TERMINAL	MAIN-MODE	THE OTHERS				
Decode Circuit (PB)											
9-1	PB Out Level	γ_{PB}					1. γ_{IN} (FM IN) : 1.3 / 1.7 MHz (NTSC) 100 mV _{p-p} (L + R) ; 50 mV _{p-p} /ch 400 Hz, 50 kHz Dev. 2. Measure : γ_{OUT} (Line Out)	(TA1246F) -12.5 -11.0 (TA1246AF)	-9.5		dBV
9-2	PB Out Level L / R Ratio	Δ_{GPB}					1. 9-1 : γ_{OUT} (Line Out) Measure the difference at the level of L-ch and R-ch.	-1.5	0	1.5	dB
9-3	PB Out Distortion (Design Grantee)	DPB					1. γ_{IN} (FM IN) : 1.3 / 1.7 MHz (NTSC) 100 mV _{p-p} (L + R) ; 50 mV _{p-p} /ch 1 kHz, 50 kHz Dev. 2. Measure distortion γ_{OUT} (Line Out)	-	0.1	0.2	%
9-4	PB Out Max Level	γ_{PB} Max			FM IN (L + R) 25 → Line Out 11, 13		1. γ_{IN} (FM IN) : 1.3 / 1.7 MHz (NTSC) 100 mV _{p-p} (L + R) ; 50 mV _{p-p} /ch Dev. (\pm kHz) up. 2. Measure : γ_{OUT} (Line Out) at THD 1%	7.6	8.6	-	dBV
9-5	PB Decode Expand	LDec					1. γ_{IN} (FM IN) : 1.3 / 1.7 MHz (NTSC) 100 mV _{p-p} (L + R) ; 50 mV _{p-p} /ch 400 Hz, 5 k / 50 kHz Dev. 2. γ_{OUT} (Line Out) Input two kinds of signal and measure the difference of the outputs.	41	43	46	dB

CHARACTERISTICS		SYMBOL	TEST CIRCUIT	TEST CONDITION			MIN.	TYP.	MAX.	UNIT
Bl. No.	ITEM			TEST TERMINAL	MAIN-MODE	THE OTHERS				
10-1	Demo Max Frequency	DemMax	FM IN 25 → Line Out 11, 13	PB NTSC	1. ν_{IN} (FM IN) : 1.3 / 1.7 MHz (NTSC) 100 mV _{p-p} (L + R) ; 50 mV _{p-p} / ch 400 Hz, Dev. (\pm kHz) up. 2. Measure deviation : YOUT (Monitor Out) at THD 2%.	210	240	-	kHz	
10-2	Demo Minimum Input Level	$\nu_{Demo Min}$			1. ν_{IN} (FM IN) : 1.3 / 1.7 MHz (NTSC) 100 mV _{p-p} (L + R) ; 50 mV _{p-p} / ch 400 Hz, 50 kHz Dev. 2. Measure ν_{IN} level : YOUT (Monitor Out) at THD 2%. () : R-ch	0.3 (0.5)	0.7 1.3	1.1 2.5	mV _{p-p}	

TA1246F / AF-58

CHARACTERISTICS		SYMBOL	TEST CIRCUIT	TEST CONDITION			MIN.	TYP.	MAX.	UNIT
				TEST TERMINAL	MAIN-MODE	THE OTHERS				
11-1	Switching Pulse Threshold Level	V_{28th}	—							
SWP				SWP IN 28 → Monitor Out 30	PB NTSC	<ol style="list-style-type: none"> V_{IN1} (FM IN) : 1.3 / 1.7 MHz (NTSC) 100 mV_{p-p} (L + R) : 50 mV_{p-p} / ch FM : No Dev. V_{IN} : Pin 28 (SWP IN) : 1 kHz square wave, 5 V_{p-p}. Pin 31 : GND V_{OUT} (Monitor Out) Reduce the level of pin 28. Measure the level of pin 28 when the output disappears. 	1.0	1.5	2.0	V

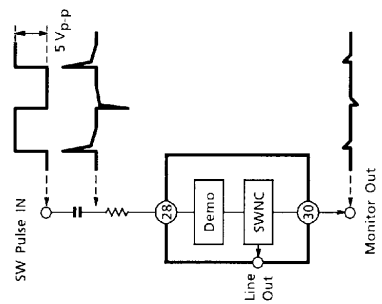

Bl.	CHARACTERISTICS		SYMBOL	TEST CIRCUIT	TEST TERMINAL	TEST CONDITION		MIN.	TYP.	MAX.	UNIT	
	No.	ITEM				MAIN-MODE	THE OTHERS					
BPF (PB) NTSC	12-1	NTSC L-ch 900 kHz ($f_0 - 400$ k) Point Gain.1	GBPF.L -400 NTSC	-			1. V_{IN} (FM IN) : CW sin wave 25 mV _{p-p} 2. Pin 24 (FM AGC Filter) DC : 1 V fix 3. Pin 27 (Hi-Fi Det Out) DC : 9 V BPF Monitor ON 4. Pin 31 (Norm IN) DC : GND BPF L-ch Monitor 5. V_{OUT} (FM Out) Monitor	-	-42	-30		
	12-2	NTSC L-ch 1.7 MHz ($f_0 + 400$ k) Point Gain.2	GBPF.L +400 NTSC		PB	FM IN 25 → FM Out 22		-	-45	-28		
	12-3	NTSC L-ch 1.15 MHz ($f_0 - 150$ k) Point Gain.3	GBPF.L -150 NTSC		NTSC				-5.5	-2.5	-0.5	dB
	12-4	NTSC L-ch 1.45 MHz ($f_0 + 150$ k) Point Gain.4	GBPF.L +150 NTSC						-7.3	-3.3	-0.3	dB

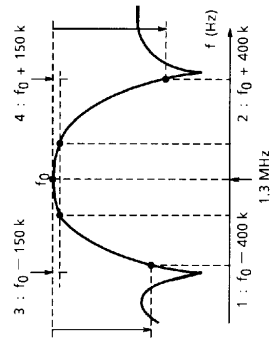

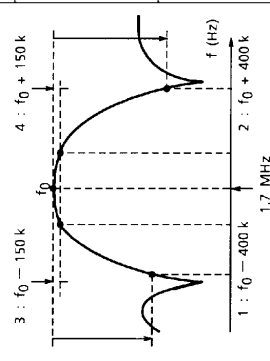
CHARACTERISTICS		SYMBOL	TEST CIR-CUIT	TEST CONDITION			MIN.	TYP.	MAX.	UNIT				
Bl. No.	ITEM			TEST TERMINAL	MAIN-MODE	THE OTHERS								
BPF (PB) NTSC	12-5	NTSC R-ch 1.3 MHz ($f_0 - 400$ k) Point Gain.1	—	FM IN 25 → FM Out 22	PB NTSC	1. V_{IN} (FM IN) : CW sin wave 25 mV _{p-p} 2. Pin 24 (FM AGC Filter) DC : 1 V fix 3. Pin 27 (Hi-Fi Det Out) DC : 9 V BPF Monitor ON 4. Pin 31 (Norm IN) DC : 9 V BPF R-ch Monitor 5. V_{OUT} (FM Out) Monitor 	—	-43	-36					
	12-6	NTSC R-ch 2.1 MHz ($f_0 + 400$ k) Point Gain.2									-27	-18		
	12-7	NTSC R-ch 1.55 MHz ($f_0 - 150$ k) Point Gain.3					GBPF.R -400 NTSC	GBPF.R +400 NTSC	GBPF.R -150 NTSC		-7	-3	0	dB
	12-8	NTSC R-ch 1.85 MHz ($f_0 + 150$ k) Point Gain.4					GBPF.R +150 NTSC				-8	-4	1	

CHARACTERISTICS		SYMBOL	TEST CIRCUIT	TEST CONDITION			MIN.	TYP.	MAX.	UNIT			
Bl. No.	ITEM			TEST TERMINAL	MAIN-MODE	THE OTHERS							
BPF (PB) PAL	13-1	PAL L-ch 1.0 MHz ($f_0 - 400\text{ k}$) Point Gain.1	-	FM IN 25 → FM Out 22	PB PAL	1. VIN (FM IN) : CW sin wave 25 mV _{p-p} 2. Pin 24 (FM AGC Filter) DC : 1 V fix 3. Pin 27 (Hi-Fi Det Out) DC : 9 V BPF Monitor ON 4. Pin 31 (Norm IN) DC : GND BPF L-ch Monitor 5. VOUT (FM Out) Monitor 	-	-34	-24				
	13-2	PAL L-ch 1.8 MHz ($f_0 + 400\text{ k}$) Point Gain.2											
	13-3	PAL L-ch 1.25 MHz ($f_0 - 150\text{ k}$) Point Gain.3											
	13-4	PAL L-ch 1.55 MHz ($f_0 + 150\text{ k}$) Point Gain.4											

TA1246F / AF - 62

CHARACTERISTICS		SYMBOL	TEST CIRCUIT	TEST CONDITION			MIN.	TYP.	MAX.	UNIT
Bl. No.	ITEM			TEST TERMINAL	MAIN-MODE	THE OTHERS				
BPF (PB) PAL	13-5	GBPF.R -400 PAL PAL R-ch 1.4 MHz ($f_0 - 400$ k) Point Gain.1			1. VIN (FM IN) : CW sin wave 25 mV _{p-p} 2. Pin 24 (FM AGC Filter) DC : 1 V fix 3. Pin 27 (Hi-Fi Det Out) DC : 9 V BPF Monitor ON 4. Pin 31 (Norm IN) DC : 9 V BPF R-ch Monitor 5. VOUT (FM Out) Monitor	-	-45	-28		
	13-6	GBPF.R +400 PAL PAL R-ch 2.2 MHz ($f_0 + 400$ k) Point Gain.2					-23	-14		
	13-7	GBPF.R -150 PAL PAL R-ch 1.65 MHz ($f_0 - 150$ k) Point Gain.3	FM IN 25 → FM Out 22	PB PAL			-7	-3	0	dB
	13-8	GBPF.R +150 PAL PAL R-ch 1.95 MHz ($f_0 + 150$ k) Point Gain.4					-5.4	-2.8	-0.2	

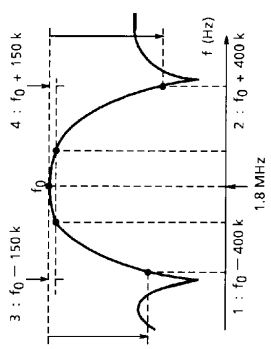

BI.	CHARACTERISTICS		SYMBOL	TEST CIRCUIT	TEST TERMINAL	TEST CONDITION		MIN.	TYP.	MAX.	UNIT
	No.	ITEM				MAIN-MODE	THE OTHERS				
14-1	DOC Det Level (NTSC L-ch)	LDOC.R NTSC	—	FM IN 25 → FM AGC Filter 24	PB NTSC FM AGC R-ch	<ol style="list-style-type: none"> 1. V_{IN} (FM IN L-ch) : 1.7 MHz, 150 mV_{p-p} (First of all) 2. Bus : PB FM AGC "R-ch mode" 3. Bus : NTSC/PAL "NTSC mode" 4. Pin 24 (FM AGC Filter) : V.AGC DC (V) monitor 5. Reduce the level of V_{IN}. Measure the level of V_{IN} when the voltage of V.AGC becomes 0.6 V. → V_{IN} (O) 6. In addition, the level of V_{IN} is reduced. 7. LDOC = $20 \log (V_{IN} (D) / V_{IN} (O))$ () : L-ch 		-22 (-24)	-19 (-21)	-16 (-17)	dB

CHARACTERISTICS		SYMBOL	TEST CIRCUIT	TEST CONDITION			MIN.	TYP.	MAX.	UNIT
Bl. No.	ITEM			TEST TERMINAL	MAIN-MODE	THE OTHERS				
DOC Det (PB)	14-2	DOC Det Hysteresis (NTSC L-ch)								
				PB NTSC FM AGC R-ch	1. On condition that 14-1. Raise the level of V_{IN} . Measure the level of V_{IN} when the voltage pin 27 becomes Low. $\rightarrow V_{IN}$ (H) becomes Low. $\rightarrow V_{IN}$ (H) / V_{IN} (O)) 2. L-Hys = 20 f _{og} (V_{IN} (H) / V_{IN} (O)) 3. HYS = LDOC - L-Hys () : L-ch	1 (2)	4 (5)	7 (8)	dB	
				PB NTSC FM AGC R-ch PB FM Gain 0 dB	1. On condition that 14-1. 2. Bus : FM AGC "R-ch" 3. V_{IN} : Pin 25 (FM IN) 1.7 MHz 4. Reduce the level of V_{IN} . Measure the level of V_{IN} when the voltage pin 27 becomes HIGH.	1.5	2.5	4.5	mV _{p-p}	
Hi-Fi Det./Env. Det. (PB) PAL	15-1	Non Hi-Fi Det Level.1 (NTSC R-ch)								
				FM IN 25 \rightarrow FM AGC Filter 24 Hi-Fi Det Out 27						
				PB NTSC FM AGC R-ch PB FM Gain 3 dB	1. Bus PB AGC Gain "3 dB" mode 2. On condition that 15-1. 3. V_{IN} : Pin 25 (FM IN) 1.7 MHz 4. Reduce the level of V_{IN} . Measure the level of V_{IN} when the voltage pin 27 becomes HIGH.	0.8	1.8	3.2		
	15-2	Non Hi-Fi Det Level.3 (NTSC R-ch 3 dB)								

CHARACTERISTICS		SYMBOL	TEST CIRCUIT	TEST CONDITION			MIN.	TYP.	MAX.	UNIT
Bl. No.	ITEM			TEST TERMINAL	MAIN-MODE	THE OTHERS				
15-3	Non Hi-Fi Det Out Level	V38 N.H.	-	FM IN 25 → FM AGC Filter	PB	1. On condition that 15-1. 2. V_{IN} : Pin 25 (FM IN) no input 3. Measure : Pin 27 voltage.	4.1	4.3	4.5	V
				24	FM AGC R-ch	1. On condition that 15-1. 2. V_{IN} : Pin 25 (FM IN) 1.7 MHz, 150 mV _{p-p} 3. Measure : Pin 27 voltage.				
15-4	Hi-Fi Det Out Level	V38 Hi-Fi	-	Hi-Fi Det Out 27	PB FM Gain 0 dB	1. V_{IN} (FM IN) : 1.7 MHz 50 & 150 mV _{p-p} 2. V_{OUT} (Env Det Out) Measure the output voltage when each signal is input. () : L-ch	-	-	0.1	
15-5	Env. Det Out Level.1	V41.1 NTSC	-	FM IN 25 → Env Det Out 26	PB	1. V_{IN} (FM IN) : 1.7 MHz 50 & 150 mV _{p-p} 2. V_{OUT} (Env Det Out) Measure the output voltage when each signal is input. () : L-ch	1.2 (0.9)	1.4 (1.2)	1.6 (1.5)	V
					NTSC					
15-6	Env. Det Out Level.2	V41.2 NTSC	-	FM IN 25 → Env Det Out 26	FM AGC R-ch	1. V_{IN} (FM IN) : 1.7 MHz 50 & 150 mV _{p-p} 2. V_{OUT} (Env Det Out) Measure the output voltage when each signal is input. () : L-ch	3.2 (2.2)	3.5 (3.0)	3.8 (3.7)	V
					PB FM Gain 0 dB					

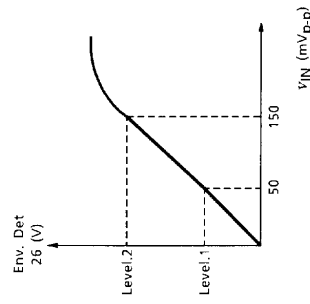

The signal levels of these measurements are the input levels to external circuit. (It is not at a direct signal level of the terminal.)

SETTING OF BUS & SW

ITEM		1-1	1-2	2-1	2-2	2-3	2-4	2-5	2-6	2-7	2-8	2-9	2-10	2-11	2-12	2-13	2-14	2-15		
SA No. 0	EE / Rec / PB	EE	—	—	—	—	—	—	—	—	—	—	—	—	—	—	—	—	—	
		Rec	●	—	—	—	—	—	—	—	—	—	—	—	—	—	—	—	—	—
	Mute	PB	—	●	—	—	—	—	—	—	—	—	—	—	—	—	—	—	—	—
		ON	○	○	—	—	—	—	—	—	—	—	—	—	—	—	—	—	—	—
	Rec Norm Out Select	Off	—	—	—	—	—	—	—	—	—	—	—	—	—	—	—	—	—	—
		Mix	—	—	—	—	—	—	—	—	—	—	●	—	—	—	—	—	—	—
		Dual	—	—	—	—	—	—	—	—	—	—	—	●	—	—	—	—	—	—
	Hi-Fi Select	Line.3 (L)	—	—	—	—	—	—	—	—	—	—	—	●	—	—	—	—	—	—
		TV	○	○	●	—	—	—	—	●	●	—	—	●	●	—	—	—	—	—
		Line.1	—	—	—	●	—	—	—	—	—	—	—	—	—	—	—	—	—	—
		Line.2	—	—	—	—	●	—	—	—	—	—	—	—	—	—	—	—	—	—
	Log / J.Clock	Line.3	—	—	—	—	—	●	—	—	—	—	—	—	●	●	●	—	—	—
Log		○	○	○	○	○	○	○	○	○	○	○	○	○	○	○	○	○	○	
SA No. 1	Output Select	Just Clock	—	—	—	—	—	—	—	—	—	—	—	—	—	—	—	—	—	
		Stereo	○	○	○	○	○	○	○	○	○	○	○	○	○	○	○	○	○	○
	EVR	Hi-Fi (L)	—	—	—	—	—	—	—	—	—	—	—	—	—	—	—	—	—	—
		Hi-Fi (R)	—	—	—	—	—	—	—	—	—	—	—	—	—	—	—	—	—	—
		Hi (LR) + Norm	—	—	—	—	—	—	—	—	—	—	—	—	—	—	—	—	—	—
		Hi (L) + Norm	—	—	—	—	—	—	—	—	—	—	—	—	—	—	—	—	—	—
		Hi (R) + Norm	—	—	—	—	—	—	—	—	—	—	—	—	—	—	—	—	—	—
		Norm	—	—	—	—	—	—	—	—	—	—	—	—	—	—	—	—	●	●
		Line.2 Stereo	—	—	—	—	—	—	—	—	●	—	—	—	—	—	—	—	—	—
	BPF	Line.2 (L)	—	—	—	—	—	—	—	—	—	—	—	—	—	—	—	—	—	—
		Line.2 (R)	—	—	—	—	—	—	—	—	—	—	—	—	—	—	—	—	—	—
		Line.3 Stereo	—	—	—	—	—	—	—	—	—	●	—	—	—	—	—	—	—	—
		Line.3 (L)	—	—	—	—	—	—	—	—	—	—	—	—	—	—	—	—	—	—
		Line.3 (R)	—	—	—	—	—	—	—	—	—	—	—	—	—	—	—	—	—	—
		Through	○	○	○	○	○	○	○	○	○	○	○	○	○	○	○	○	○	○
Auto BPF Request	ALC	—	—	—	—	—	—	—	—	—	—	—	—	—	—	—	—	—	—	
	Manual	—	—	—	—	—	—	—	—	—	—	—	—	—	—	—	—	—	—	
SA No. 2	Mod f ₀ / BPF	Auto	○	○	○	○	○	○	○	○	○	○	○	○	○	○	○	○	○	
		Manual	—	—	—	—	—	—	—	—	—	—	—	—	—	—	—	—	—	—
	PB FM Gain	Off	○	○	○	○	○	○	○	○	○	○	○	○	○	○	○	○	○	○
		ON	—	—	—	—	—	—	—	—	—	—	—	—	—	—	—	—	—	—
	PB FM AGC (L / R)	0 dB	○	○	○	○	○	○	○	○	○	○	○	○	○	○	○	○	○	○
		3 dB	—	—	—	—	—	—	—	—	—	—	—	—	—	—	—	—	—	—
	SW N.C. Pulse Width	R-ch	○	○	○	○	○	○	○	○	○	○	○	○	○	○	○	○	○	○
		L-ch	—	—	—	—	—	—	—	—	—	—	—	—	—	—	—	—	—	—
		11.6 μs	—	—	—	—	—	—	—	—	—	—	—	—	—	—	—	—	—	—
		10.0 μs	—	—	—	—	—	—	—	—	—	—	—	—	—	—	—	—	—	—
8.5 μs		—	—	—	—	—	—	—	—	—	—	—	—	—	—	—	—	—	—	
7.8 μs		—	—	—	—	—	—	—	—	—	—	—	—	—	—	—	—	—	—	
FM L / R Mix Ratio	7.4 μs	○	○	○	○	○	○	○	○	○	○	○	○	○	○	○	○	○	○	
	7.0 μs	—	—	—	—	—	—	—	—	—	—	—	—	—	—	—	—	—	—	
	6.7 μs	—	—	—	—	—	—	—	—	—	—	—	—	—	—	—	—	—	—	
	6.4 μs	—	—	—	—	—	—	—	—	—	—	—	—	—	—	—	—	—	—	
TSW.1 (7pin : WE)	8.5 dB	—	—	—	—	—	—	—	—	—	—	—	—	—	—	—	—	—	—	
	10 dB	○	○	○	○	○	○	○	○	○	○	○	○	○	○	○	○	○	○	
TSW.2 (AUX MUTE)	12 dB	—	—	—	—	—	—	—	—	—	—	—	—	—	—	—	—	—	—	
	14 dB	—	—	—	—	—	—	—	—	—	—	—	—	—	—	—	—	—	—	
TSW.3 (L.O.(L))	(A)	○	○	○	○	○	○	○	○	○	○	○	○	○	○	○	○	○	○	
	B	—	—	—	—	—	—	—	—	—	—	—	—	—	—	—	—	—	—	
TSW.4 (L.O.(R))	(A) : Off	○	○	○	○	○	○	○	○	○	○	○	○	○	○	○	○	○	○	
	B : ON	—	—	—	—	—	—	—	—	—	—	—	—	—	—	—	—	—	—	
TSW.5 (32pin : WE)	(A)	○	○	○	○	○	○	○	○	○	○	○	○	○	○	○	○	○	○	
	B	—	—	—	—	—	—	—	—	—	—	—	—	—	—	—	—	—	—	
TSW.A (36pin)	A	—	—	—	—	—	—	—	—	—	—	—	—	—	—	—	—	—	—	
	(C)	○	○	○	○	○	○	○	○	○	○	○	○	○	○	○	○	○	○	
TSW.B (30pin)	B	—	—	—	—	—	—	—	—	—	—	—	—	—	—	—	—	—	—	
	L	—	—	—	—	—	—	—	—	—	—	—	—	—	—	—	—	—	—	
TSW.C (27pin)	(C)	○	○	○	○	○	○	○	○	○	○	○	○	○	○	○	○	○	○	
	R	—	—	—	—	—	—	—	—	—	—	—	—	—	—	—	—	—	—	
	(A)	○	○	○	○	○	○	○	○	○	○	○	○	○	○	○	○	○	○	
	B	—	—	—	—	—	—	—	—	—	—	—	—	—	—	—	—	—	—	

ITEM		2-16	2-17	2-18	3-1	3-2	3-3	3-4	3-5	3-6	3-7	3-8	3-9	3-10	3-11	3-12	4-1	4-2	
SA No. 0	EE / Rec / PB	EE	<input type="radio"/>	<input type="radio"/>	<input type="radio"/>	<input type="radio"/>	<input type="radio"/>	<input type="radio"/>	<input type="radio"/>	<input type="radio"/>	<input type="radio"/>	<input type="radio"/>	<input type="radio"/>	<input type="radio"/>	<input type="radio"/>	<input type="radio"/>	<input type="radio"/>	<input type="radio"/>	
		Rec	<input type="radio"/>	<input type="radio"/>	<input type="radio"/>	<input type="radio"/>	<input type="radio"/>	<input type="radio"/>	<input type="radio"/>	<input type="radio"/>	<input type="radio"/>	<input type="radio"/>	<input type="radio"/>	<input type="radio"/>	<input type="radio"/>	<input type="radio"/>	<input type="radio"/>	<input type="radio"/>	
		PB	<input type="radio"/>	<input type="radio"/>	<input type="radio"/>	<input type="radio"/>	<input type="radio"/>	<input type="radio"/>	<input type="radio"/>	<input type="radio"/>	<input type="radio"/>	<input type="radio"/>	<input type="radio"/>	<input type="radio"/>	<input type="radio"/>	<input type="radio"/>	<input type="radio"/>	<input type="radio"/>	
	Mute	ON	<input type="radio"/>	<input type="radio"/>	<input type="radio"/>	<input type="radio"/>	<input type="radio"/>	<input type="radio"/>	<input type="radio"/>	<input type="radio"/>	<input type="radio"/>	<input type="radio"/>	<input type="radio"/>	<input type="radio"/>	<input type="radio"/>	<input type="radio"/>	<input type="radio"/>	<input type="radio"/>	<input type="radio"/>
		Off	<input type="radio"/>	<input type="radio"/>	<input type="radio"/>	<input type="radio"/>	<input type="radio"/>	<input type="radio"/>	<input type="radio"/>	<input type="radio"/>	<input type="radio"/>	<input type="radio"/>	<input type="radio"/>	<input type="radio"/>	<input type="radio"/>	<input type="radio"/>	<input type="radio"/>	<input type="radio"/>	<input type="radio"/>
	Rec Norm Out Select	Mix	<input type="radio"/>	<input type="radio"/>	<input type="radio"/>	<input type="radio"/>	<input type="radio"/>	<input type="radio"/>	<input type="radio"/>	<input type="radio"/>	<input type="radio"/>	<input type="radio"/>	<input type="radio"/>	<input type="radio"/>	<input type="radio"/>	<input type="radio"/>	<input type="radio"/>	<input type="radio"/>	<input type="radio"/>
		Dual	<input type="radio"/>	<input type="radio"/>	<input type="radio"/>	<input type="radio"/>	<input type="radio"/>	<input type="radio"/>	<input type="radio"/>	<input type="radio"/>	<input type="radio"/>	<input type="radio"/>	<input type="radio"/>	<input type="radio"/>	<input type="radio"/>	<input type="radio"/>	<input type="radio"/>	<input type="radio"/>	<input type="radio"/>
	Hi-Fi Select	Line.3 (L)	<input type="radio"/>	<input type="radio"/>	<input type="radio"/>	<input type="radio"/>	<input type="radio"/>	<input type="radio"/>	<input type="radio"/>	<input type="radio"/>	<input type="radio"/>	<input type="radio"/>	<input type="radio"/>	<input type="radio"/>	<input type="radio"/>	<input type="radio"/>	<input type="radio"/>	<input type="radio"/>	<input type="radio"/>
		TV	<input checked="" type="radio"/>	<input checked="" type="radio"/>	<input checked="" type="radio"/>	<input checked="" type="radio"/>	<input checked="" type="radio"/>	<input checked="" type="radio"/>	<input checked="" type="radio"/>	<input checked="" type="radio"/>	<input checked="" type="radio"/>	<input checked="" type="radio"/>	<input checked="" type="radio"/>	<input checked="" type="radio"/>	<input checked="" type="radio"/>	<input checked="" type="radio"/>	<input type="radio"/>	<input type="radio"/>	<input type="radio"/>
		Line.1	<input type="radio"/>	<input type="radio"/>	<input type="radio"/>	<input type="radio"/>	<input type="radio"/>	<input type="radio"/>	<input type="radio"/>	<input type="radio"/>	<input type="radio"/>	<input type="radio"/>	<input type="radio"/>	<input type="radio"/>	<input type="radio"/>	<input type="radio"/>	<input type="radio"/>	<input type="radio"/>	<input type="radio"/>
Line.2		<input type="radio"/>	<input type="radio"/>	<input type="radio"/>	<input type="radio"/>	<input type="radio"/>	<input type="radio"/>	<input type="radio"/>	<input type="radio"/>	<input type="radio"/>	<input type="radio"/>	<input type="radio"/>	<input type="radio"/>	<input type="radio"/>	<input type="radio"/>	<input type="radio"/>	<input type="radio"/>	<input type="radio"/>	
Log / J.Clock	Line.3	<input type="radio"/>	<input type="radio"/>	<input type="radio"/>	<input type="radio"/>	<input type="radio"/>	<input type="radio"/>	<input type="radio"/>	<input type="radio"/>	<input type="radio"/>	<input type="radio"/>	<input type="radio"/>	<input type="radio"/>	<input type="radio"/>	<input type="radio"/>	<input type="radio"/>	<input type="radio"/>	<input type="radio"/>	
	Log	<input type="radio"/>	<input type="radio"/>	<input type="radio"/>	<input type="radio"/>	<input type="radio"/>	<input type="radio"/>	<input type="radio"/>	<input type="radio"/>	<input type="radio"/>	<input type="radio"/>	<input type="radio"/>	<input type="radio"/>	<input type="radio"/>	<input type="radio"/>	<input type="radio"/>	<input type="radio"/>	<input type="radio"/>	
SA No. 1	Just Clock	Just Clock	<input type="radio"/>	<input type="radio"/>	<input type="radio"/>	<input type="radio"/>	<input type="radio"/>	<input type="radio"/>	<input type="radio"/>	<input type="radio"/>	<input type="radio"/>	<input type="radio"/>	<input type="radio"/>	<input type="radio"/>	<input type="radio"/>	<input type="radio"/>	<input type="radio"/>	<input type="radio"/>	
		Stereo	<input type="radio"/>	<input type="radio"/>	<input type="radio"/>	<input type="radio"/>	<input type="radio"/>	<input type="radio"/>	<input type="radio"/>	<input type="radio"/>	<input type="radio"/>	<input type="radio"/>	<input type="radio"/>	<input type="radio"/>	<input type="radio"/>	<input type="radio"/>	<input type="radio"/>	<input type="radio"/>	
	Output Select	Hi-Fi (L)	<input type="radio"/>	<input type="radio"/>	<input type="radio"/>	<input type="radio"/>	<input type="radio"/>	<input type="radio"/>	<input type="radio"/>	<input type="radio"/>	<input type="radio"/>	<input type="radio"/>	<input type="radio"/>	<input type="radio"/>	<input type="radio"/>	<input type="radio"/>	<input type="radio"/>	<input type="radio"/>	<input checked="" type="radio"/>
		Hi-Fi (R)	<input type="radio"/>	<input type="radio"/>	<input type="radio"/>	<input type="radio"/>	<input type="radio"/>	<input type="radio"/>	<input type="radio"/>	<input type="radio"/>	<input type="radio"/>	<input type="radio"/>	<input type="radio"/>	<input type="radio"/>	<input type="radio"/>	<input type="radio"/>	<input type="radio"/>	<input type="radio"/>	<input type="radio"/>
		Hi (LR) + Norm	<input checked="" type="radio"/>	<input checked="" type="radio"/>	<input checked="" type="radio"/>	<input type="radio"/>	<input type="radio"/>	<input type="radio"/>	<input type="radio"/>	<input type="radio"/>	<input type="radio"/>	<input type="radio"/>	<input type="radio"/>	<input type="radio"/>	<input type="radio"/>	<input type="radio"/>	<input type="radio"/>	<input type="radio"/>	<input type="radio"/>
		Hi (L) + Norm	<input type="radio"/>	<input type="radio"/>	<input type="radio"/>	<input type="radio"/>	<input type="radio"/>	<input type="radio"/>	<input type="radio"/>	<input type="radio"/>	<input type="radio"/>	<input type="radio"/>	<input type="radio"/>	<input type="radio"/>	<input type="radio"/>	<input type="radio"/>	<input type="radio"/>	<input type="radio"/>	<input type="radio"/>
		Hi (R) + Norm	<input type="radio"/>	<input type="radio"/>	<input type="radio"/>	<input type="radio"/>	<input type="radio"/>	<input type="radio"/>	<input type="radio"/>	<input type="radio"/>	<input type="radio"/>	<input type="radio"/>	<input type="radio"/>	<input type="radio"/>	<input type="radio"/>	<input type="radio"/>	<input type="radio"/>	<input type="radio"/>	<input type="radio"/>
		Norm	<input type="radio"/>	<input type="radio"/>	<input type="radio"/>	<input type="radio"/>	<input type="radio"/>	<input type="radio"/>	<input type="radio"/>	<input type="radio"/>	<input type="radio"/>	<input type="radio"/>	<input type="radio"/>	<input type="radio"/>	<input type="radio"/>	<input type="radio"/>	<input type="radio"/>	<input type="radio"/>	<input type="radio"/>
		Line.2 Stereo	<input type="radio"/>	<input type="radio"/>	<input type="radio"/>	<input type="radio"/>	<input type="radio"/>	<input type="radio"/>	<input type="radio"/>	<input type="radio"/>	<input type="radio"/>	<input type="radio"/>	<input type="radio"/>	<input type="radio"/>	<input type="radio"/>	<input type="radio"/>	<input type="radio"/>	<input type="radio"/>	<input type="radio"/>
	Line.2 (L)	<input type="radio"/>	<input type="radio"/>	<input type="radio"/>	<input type="radio"/>	<input type="radio"/>	<input type="radio"/>	<input type="radio"/>	<input type="radio"/>	<input type="radio"/>	<input type="radio"/>	<input type="radio"/>	<input type="radio"/>	<input type="radio"/>	<input type="radio"/>	<input type="radio"/>	<input type="radio"/>	<input type="radio"/>	
	Line.2 (R)	<input type="radio"/>	<input type="radio"/>	<input type="radio"/>	<input type="radio"/>	<input type="radio"/>	<input type="radio"/>	<input type="radio"/>	<input type="radio"/>	<input type="radio"/>	<input type="radio"/>	<input type="radio"/>	<input type="radio"/>	<input type="radio"/>	<input type="radio"/>	<input type="radio"/>	<input type="radio"/>	<input type="radio"/>	
	Line.3 Stereo	<input type="radio"/>	<input type="radio"/>	<input type="radio"/>	<input type="radio"/>	<input type="radio"/>	<input type="radio"/>	<input type="radio"/>	<input type="radio"/>	<input type="radio"/>	<input type="radio"/>	<input type="radio"/>	<input type="radio"/>	<input type="radio"/>	<input type="radio"/>	<input type="radio"/>	<input type="radio"/>	<input type="radio"/>	
	Line.3 (L)	<input type="radio"/>	<input type="radio"/>	<input type="radio"/>	<input type="radio"/>	<input type="radio"/>	<input type="radio"/>	<input type="radio"/>	<input type="radio"/>	<input type="radio"/>	<input type="radio"/>	<input type="radio"/>	<input type="radio"/>	<input type="radio"/>	<input type="radio"/>	<input type="radio"/>	<input type="radio"/>	<input type="radio"/>	
	Line.3 (R)	<input type="radio"/>	<input type="radio"/>	<input type="radio"/>	<input type="radio"/>	<input type="radio"/>	<input type="radio"/>	<input type="radio"/>	<input type="radio"/>	<input type="radio"/>	<input type="radio"/>	<input type="radio"/>	<input type="radio"/>	<input type="radio"/>	<input type="radio"/>	<input type="radio"/>	<input type="radio"/>	<input type="radio"/>	
	EVR	Through	<input type="radio"/>	<input type="radio"/>	<input type="radio"/>	<input type="radio"/>	<input type="radio"/>	<input type="radio"/>	<input type="radio"/>	<input type="radio"/>	<input type="radio"/>	<input type="radio"/>	<input type="radio"/>	<input type="radio"/>	<input type="radio"/>	<input type="radio"/>	<input type="radio"/>	<input type="radio"/>	<input type="radio"/>
ALC		<input type="radio"/>	<input type="radio"/>	<input type="radio"/>	<input type="radio"/>	<input type="radio"/>	<input type="radio"/>	<input type="radio"/>	<input type="radio"/>	<input type="radio"/>	<input type="radio"/>	<input type="radio"/>	<input type="radio"/>	<input type="radio"/>	<input type="radio"/>	<input type="radio"/>	<input type="radio"/>	<input type="radio"/>	
BPF	Manual	<input type="radio"/>	<input type="radio"/>	<input type="radio"/>	<input checked="" type="radio"/>	<input checked="" type="radio"/>	<input checked="" type="radio"/>	<input checked="" type="radio"/>	<input checked="" type="radio"/>	<input checked="" type="radio"/>	<input checked="" type="radio"/>	<input checked="" type="radio"/>	<input checked="" type="radio"/>	<input checked="" type="radio"/>	<input checked="" type="radio"/>	<input checked="" type="radio"/>	<input type="radio"/>	<input type="radio"/>	
	Auto	<input type="radio"/>	<input type="radio"/>	<input type="radio"/>	<input type="radio"/>	<input type="radio"/>	<input type="radio"/>	<input type="radio"/>	<input type="radio"/>	<input type="radio"/>	<input type="radio"/>	<input type="radio"/>	<input type="radio"/>	<input type="radio"/>	<input type="radio"/>	<input type="radio"/>	<input type="radio"/>	<input type="radio"/>	
Auto BPF Request	Manual	<input type="radio"/>	<input type="radio"/>	<input type="radio"/>	<input type="radio"/>	<input type="radio"/>	<input type="radio"/>	<input type="radio"/>	<input type="radio"/>	<input type="radio"/>	<input type="radio"/>	<input type="radio"/>	<input type="radio"/>	<input type="radio"/>	<input type="radio"/>	<input type="radio"/>	<input type="radio"/>	<input type="radio"/>	
	Off	<input type="radio"/>	<input type="radio"/>	<input type="radio"/>	<input type="radio"/>	<input type="radio"/>	<input type="radio"/>	<input type="radio"/>	<input type="radio"/>	<input type="radio"/>	<input type="radio"/>	<input type="radio"/>	<input type="radio"/>	<input type="radio"/>	<input type="radio"/>	<input type="radio"/>	<input type="radio"/>	<input type="radio"/>	
SA No. 2	Mod f ₀ / BPF	ON	<input type="radio"/>	<input type="radio"/>	<input type="radio"/>	<input type="radio"/>	<input type="radio"/>	<input type="radio"/>	<input type="radio"/>	<input type="radio"/>	<input type="radio"/>	<input type="radio"/>	<input type="radio"/>	<input type="radio"/>	<input type="radio"/>	<input type="radio"/>	<input type="radio"/>	<input type="radio"/>	
		NTSC	<input type="radio"/>	<input type="radio"/>	<input type="radio"/>	<input type="radio"/>	<input type="radio"/>	<input type="radio"/>	<input type="radio"/>	<input type="radio"/>	<input type="radio"/>	<input type="radio"/>	<input type="radio"/>	<input type="radio"/>	<input type="radio"/>	<input type="radio"/>	<input type="radio"/>	<input type="radio"/>	<input type="radio"/>
	PB FM Gain	PAL	<input type="radio"/>	<input type="radio"/>	<input type="radio"/>	<input type="radio"/>	<input type="radio"/>	<input type="radio"/>	<input type="radio"/>	<input type="radio"/>	<input type="radio"/>	<input type="radio"/>	<input type="radio"/>	<input type="radio"/>	<input type="radio"/>	<input type="radio"/>	<input type="radio"/>	<input type="radio"/>	<input type="radio"/>
		0 dB	<input type="radio"/>	<input type="radio"/>	<input type="radio"/>	<input type="radio"/>	<input type="radio"/>	<input type="radio"/>	<input type="radio"/>	<input type="radio"/>	<input type="radio"/>	<input type="radio"/>	<input type="radio"/>	<input type="radio"/>	<input type="radio"/>	<input type="radio"/>	<input type="radio"/>	<input type="radio"/>	<input type="radio"/>
	PB FM AGC (L/R)	3 dB	<input type="radio"/>	<input type="radio"/>	<input type="radio"/>	<input type="radio"/>	<input type="radio"/>	<input type="radio"/>	<input type="radio"/>	<input type="radio"/>	<input type="radio"/>	<input type="radio"/>	<input type="radio"/>	<input type="radio"/>	<input type="radio"/>	<input type="radio"/>	<input type="radio"/>	<input type="radio"/>	<input type="radio"/>
		R-ch	<input type="radio"/>	<input type="radio"/>	<input type="radio"/>	<input type="radio"/>	<input type="radio"/>	<input type="radio"/>	<input type="radio"/>	<input type="radio"/>	<input type="radio"/>	<input type="radio"/>	<input type="radio"/>	<input type="radio"/>	<input type="radio"/>	<input type="radio"/>	<input type="radio"/>	<input type="radio"/>	<input type="radio"/>
	SW N.C. Pulse Width	L-ch	<input type="radio"/>	<input type="radio"/>	<input type="radio"/>	<input type="radio"/>	<input type="radio"/>	<input type="radio"/>	<input type="radio"/>	<input type="radio"/>	<input type="radio"/>	<input type="radio"/>	<input type="radio"/>	<input type="radio"/>	<input type="radio"/>	<input type="radio"/>	<input type="radio"/>	<input type="radio"/>	<input type="radio"/>
		11.6 μs	<input type="radio"/>	<input type="radio"/>	<input type="radio"/>	<input type="radio"/>	<input type="radio"/>	<input type="radio"/>	<input type="radio"/>	<input type="radio"/>	<input type="radio"/>	<input type="radio"/>	<input type="radio"/>	<input type="radio"/>	<input type="radio"/>	<input type="radio"/>	<input type="radio"/>	<input type="radio"/>	<input type="radio"/>
		10.0 μs	<input type="radio"/>	<input type="radio"/>	<input type="radio"/>	<input type="radio"/>	<input type="radio"/>	<input type="radio"/>	<input type="radio"/>	<input type="radio"/>	<input type="radio"/>	<input type="radio"/>	<input type="radio"/>	<input type="radio"/>	<input type="radio"/>	<input type="radio"/>	<input type="radio"/>	<input type="radio"/>	<input type="radio"/>
		8.5 μs	<input type="radio"/>	<input type="radio"/>	<input type="radio"/>	<input type="radio"/>	<input type="radio"/>	<input type="radio"/>	<input type="radio"/>	<input type="radio"/>	<input type="radio"/>	<input type="radio"/>	<input type="radio"/>	<input type="radio"/>	<input type="radio"/>	<input type="radio"/>	<input type="radio"/>	<input type="radio"/>	<input type="radio"/>
		7.8 μs	<input type="radio"/>	<input type="radio"/>	<input type="radio"/>	<input type="radio"/>	<input type="radio"/>	<input type="radio"/>	<input type="radio"/>	<input type="radio"/>	<input type="radio"/>	<input type="radio"/>	<input type="radio"/>	<input type="radio"/>	<input type="radio"/>	<input type="radio"/>	<input type="radio"/>	<input type="radio"/>	<input type="radio"/>
		7.4 μs	<input type="radio"/>	<input type="radio"/>	<input type="radio"/>	<input type="radio"/>	<input type="radio"/>	<input type="radio"/>	<input type="radio"/>	<input type="radio"/>	<input type="radio"/>	<input type="radio"/>	<input type="radio"/>	<input type="radio"/>	<input type="radio"/>	<input type="radio"/>	<input type="radio"/>	<input type="radio"/>	<input type="radio"/>
		7.0 μs	<input type="radio"/>	<input type="radio"/>	<input type="radio"/>	<input type="radio"/>	<input type="radio"/>	<input type="radio"/>	<input type="radio"/>	<input type="radio"/>	<input type="radio"/>	<input type="radio"/>	<input type="radio"/>	<input type="radio"/>	<input type="radio"/>	<input type="radio"/>	<input type="radio"/>	<input type="radio"/>	<input type="radio"/>
	6.7 μs	<input type="radio"/>	<input type="radio"/>	<input type="radio"/>	<input type="radio"/>	<input type="radio"/>	<input type="radio"/>	<input type="radio"/>	<input type="radio"/>	<input type="radio"/>	<input type="radio"/>	<input type="radio"/>	<input type="radio"/>	<input type="radio"/>	<input type="radio"/>	<input type="radio"/>	<input type="radio"/>	<input type="radio"/>	
	FM L/R Mix Ratio	6.4 μs	<input type="radio"/>	<input type="radio"/>	<input type="radio"/>	<input type="radio"/>	<input type="radio"/>	<input type="radio"/>	<input type="radio"/>	<input type="radio"/>	<input type="radio"/>	<input type="radio"/>	<input type="radio"/>	<input type="radio"/>	<input type="radio"/>	<input type="radio"/>	<input type="radio"/>	<input type="radio"/>	<input type="radio"/>
8.5 dB		<input type="radio"/>	<input type="radio"/>	<input type="radio"/>	<input type="radio"/>	<input type="radio"/>	<input type="radio"/>	<input type="radio"/>	<input type="radio"/>	<input type="radio"/>	<input type="radio"/>	<input type="radio"/>	<input type="radio"/>	<input type="radio"/>	<input type="radio"/>	<input type="radio"/>	<input type="radio"/>	<input type="radio"/>	
10 dB		<input type="radio"/>	<input type="radio"/>	<input type="radio"/>	<input type="radio"/>	<input type="radio"/>	<input type="radio"/>	<input type="radio"/>	<input type="radio"/>	<input type="radio"/>	<input type="radio"/>	<input type="radio"/>	<input type="radio"/>	<input type="radio"/>	<input type="radio"/>	<input type="radio"/>	<input type="radio"/>	<input type="radio"/>	
12 dB		<input type="radio"/>	<input type="radio"/>	<input type="radio"/>	<input type="radio"/>	<input type="radio"/>	<input type="radio"/>	<input type="radio"/>	<input type="radio"/>	<input type="radio"/>	<input type="radio"/>	<input type="radio"/>	<input type="radio"/>	<input type="radio"/>	<input type="radio"/>	<input type="radio"/>	<input type="radio"/>	<input type="radio"/>	
TSW.1 (7pin : WE)	14 dB	<input type="radio"/>	<input type="radio"/>	<input type="radio"/>	<input type="radio"/>	<input type="radio"/>	<input type="radio"/>	<input type="radio"/>	<input type="radio"/>	<input type="radio"/>	<input type="radio"/>	<input type="radio"/>	<input type="radio"/>	<input type="radio"/>	<input type="radio"/>	<input type="radio"/>	<input type="radio"/>	<input type="radio"/>	
	(A)	<input type="radio"/>	<input type="radio"/>	<input type="radio"/>	<input type="radio"/>	<input type="radio"/>	<input type="radio"/>	<input type="radio"/>	<input type="radio"/>	<input type="radio"/>	<input type="radio"/>	<input type="radio"/>	<input type="radio"/>	<input type="radio"/>	<input type="radio"/>	<input type="radio"/>	<input type="radio"/>	<input type="radio"/>	
TSW.2 (AUX MUTE)	B	<input type="radio"/>	<input type="radio"/>	<input type="radio"/>	<input type="radio"/>	<input type="radio"/>	<input type="radio"/>	<input type="radio"/>	<input type="radio"/>	<input type="radio"/>	<input type="radio"/>	<input type="radio"/>	<input type="radio"/>	<input type="radio"/>	<input type="radio"/>	<input type="radio"/>	<input type="radio"/>	<input type="radio"/>	
	(A) : Off	<input type="radio"/>	<input type="radio"/>	<input type="radio"/>	<input type="radio"/>	<input type="radio"/>	<input type="radio"/>	<input type="radio"/>	<input type="radio"/>	<input type="radio"/>	<input type="radio"/>	<input type="radio"/>	<input type="radio"/>	<input type="radio"/>	<input type="radio"/>	<input type="radio"/>	<input type="radio"/>	<input type="radio"/>	
TSW.3 (L.O.(L))	B : ON	<input type="radio"/>	<input type="radio"/>	<input type="radio"/>	<input type="radio"/>	<input type="radio"/>	<input type="radio"/>	<input type="radio"/>	<input type="radio"/>	<input type="radio"/>	<input type="radio"/>	<input type="radio"/>	<input type="radio"/>	<input type="radio"/>	<input type="radio"/>	<input type="radio"/>	<input type="radio"/>	<input type="radio"/>	
	(A)	<input type="radio"/>	<input type="radio"/>	<input type="radio"/>	<input type="radio"/>	<input type="radio"/>	<input type="radio"/>	<input type="radio"/>	<input type="radio"/>	<input type="radio"/>	<input type="radio"/>	<input type="radio"/>	<input type="radio"/>	<input type="radio"/>	<input type="radio"/>	<input type="radio"/>	<input type="radio"/>	<input type="radio"/>	
TSW.4 (L.O.(R))	B	<input type="radio"/>	<input type="radio"/>	<input type="radio"/>	<input type="radio"/>	<input type="radio"/>	<input type="radio"/>	<input type="radio"/>	<input type="radio"/>	<input type="radio"/>	<input type="radio"/>	<input type="radio"/>	<input type="radio"/>	<input type="radio"/>	<input type="radio"/>	<input type="radio"/>	<input type="radio"/>	<input type="radio"/>	
	(A)	<input type="radio"/>	<input type="radio"/>	<input type="radio"/>	<input type="radio"/>	<input type="radio"/>	<input type="radio"/>	<input type="radio"/>	<input type="radio"/>	<input type="radio"/>	<input type="radio"/>	<input type="radio"/>	<input type="radio"/>	<input type="radio"/>	<input type="radio"/>	<input type="radio"/>	<input type="radio"/>	<input type="radio"/>	
TSW.5 (32pin : WE)	B	<input type="radio"/>	<input type="radio"/>	<input type="radio"/>	<input type="radio"/>	<input type="radio"/>	<input type="radio"/>	<input type="radio"/>	<input type="radio"/>	<input type="radio"/>	<input type="radio"/>	<input type="radio"/>	<input type="radio"/>	<input type="radio"/>	<input type="radio"/>	<input type="radio"/>	<input type="radio"/>	<input type="radio"/>	
	(A)	<input type="radio"/>	<input type="radio"/>	<input type="radio"/>	<input type="radio"/>	<input type="radio"/>	<input type="radio"/>	<input type="radio"/>	<input type="radio"/>	<input type="radio"/>	<input type="radio"/>	<input type="radio"/>	<input type="radio"/>	<input type="radio"/>	<input type="radio"/>	<input type="radio"/>	<input type="radio"/>	<input type="radio"/>	
TSW.A (36pin)	B	<input type="radio"/>	<input type="radio"/>	<input type="radio"/>	<input type="radio"/>	<input type="radio"/>	<input type="radio"/>	<input type="radio"/>	<input type="radio"/>	<input type="radio"/>	<input type="radio"/>	<input type="radio"/>	<input type="radio"/>	<input type="radio"/>	<input type="radio"/>	<input type="radio"/>	<input type="radio"/>	<input type="radio"/>	
	(C)	<input type="radio"/>	<input type="radio"/>	<input type="radio"/>	<input type="radio"/>	<input type="radio"/>	<input type="radio"/>	<input type="radio"/>	<input type="radio"/>	<input type="radio"/>	<input type="radio"/>	<input type="radio"/>	<input type="radio"/>	<input type="radio"/>	<input type="radio"/>	<input type="radio"/>	<input type="radio"/>	<input type="radio"/>	
TSW.B (30pin)	L	<input type="radio"/>																	

ITEM		4-3	4-4	4-5	4-6	5-1	5-2	5-3	5-4	5-5	6-1	6-2	6-3	6-4	6-5	6-6	6-7	6-8	
SA No. 0	EE / Rec / PB	EE	○	○	○	○	○	○	○	○	○	○	○	○	○	○	○	○	●
		Rec	—	—	—	—	—	—	—	—	—	—	—	—	●	●	—	—	—
		PB	—	—	—	—	—	—	—	—	—	—	●	—	—	—	●	●	—
	Mute	ON	—	—	—	—	—	—	—	—	—	—	—	—	—	—	—	—	—
		Off	○	○	○	○	○	○	○	○	○	○	○	○	○	○	○	○	○
	Rec Norm Out Select	Mix	○	○	○	○	○	○	○	○	○	○	○	○	○	○	○	○	○
		Dual	—	—	—	—	—	—	—	—	—	—	—	—	—	—	—	—	—
		Line.3 (L)	—	—	—	—	—	—	—	—	—	—	—	—	—	—	—	—	—
	Hi-Fi Select	TV	○	○	○	○	○	○	○	○	○	○	○	○	○	○	○	○	○
		Line.1	—	—	—	—	—	—	—	—	—	—	—	—	—	—	—	—	—
		Line.2	—	—	—	—	—	—	—	—	—	—	—	—	—	—	—	—	—
		Line.3	—	—	—	—	—	—	—	—	—	—	—	—	—	—	—	—	—
Log / J.Clock	Log	○	○	○	○	●	●	●	—	—	○	○	○	○	○	○	○	○	
	Just Clock	—	—	—	—	—	—	—	●	●	—	—	—	—	—	—	—	—	
SA No. 1	Output Select	Stereo	—	—	—	—	○	○	○	○	○	○	○	○	○	○	○	○	○
		Hi-Fi (L)	●	●	●	●	—	—	—	—	—	—	—	—	—	—	—	—	—
		Hi-Fi (R)	—	—	—	—	—	—	—	—	—	—	—	—	—	—	—	—	—
		Hi (LR) + Norm	—	—	—	—	—	—	—	—	—	—	—	—	—	—	—	—	—
		Hi (L) + Norm	—	—	—	—	—	—	—	—	—	—	—	—	—	—	—	—	—
		Hi (R) + Norm	—	—	—	—	—	—	—	—	—	—	—	—	—	—	—	—	—
		Norm	—	—	—	—	—	—	—	—	—	—	—	—	—	—	—	—	—
	EVR	Line.2 Stereo	—	—	—	—	—	—	—	—	—	—	—	—	—	—	—	—	—
		Line.2 (L)	—	—	—	—	—	—	—	—	—	—	—	—	—	—	—	—	—
		Line.2 (R)	—	—	—	—	—	—	—	—	—	—	—	—	—	—	—	—	—
		Line.3 Stereo	—	—	—	—	—	—	—	—	—	—	—	—	—	—	—	—	—
		Line.3 (L)	—	—	—	—	—	—	—	—	—	—	—	—	—	—	—	—	—
	BPF	Through	○	○	○	○	○	○	○	○	○	○	○	○	○	○	○	○	○
		ALC	—	—	—	—	—	—	—	—	—	—	—	—	—	—	—	—	—
	Auto BPF Request	Manual	—	—	—	—	—	—	—	—	—	—	—	—	—	—	—	—	—
Auto		○	○	○	○	○	○	○	○	○	○	○	○	○	○	○	○	○	
SA No. 2	Mod f ₀ / BPF	Manual	—	—	—	—	—	—	—	—	—	—	—	—	—	—	—	—	—
		NTSC	○	○	○	○	○	○	○	○	○	○	○	○	○	○	○	○	○
	PB FM Gain	PAL	—	—	—	—	—	—	—	—	—	—	—	—	—	—	—	—	—
		0 dB	○	○	○	○	○	○	○	○	○	○	○	○	○	○	○	○	○
	PB FM AGC (L/R)	3 dB	—	—	—	—	—	—	—	—	—	—	—	—	—	—	—	—	—
		R-ch	○	○	○	○	○	○	○	○	○	○	○	○	○	○	○	○	○
	SW N.C. Pulse Width	L-ch	—	—	—	—	—	—	—	—	—	—	—	—	—	—	—	—	—
		11.6 μs	—	—	—	—	—	—	—	—	—	—	—	—	—	—	—	—	—
		10.0 μs	—	—	—	—	—	—	—	—	—	—	—	—	—	—	—	—	—
		8.5 μs	—	—	—	—	—	—	—	—	—	—	—	—	—	—	—	—	—
7.8 μs		—	—	—	—	—	—	—	—	—	—	—	—	—	—	—	—	—	
7.4 μs		○	○	○	○	○	○	○	○	○	○	○	○	○	○	○	○	○	
7.0 μs		—	—	—	—	—	—	—	—	—	—	—	—	—	—	—	—	—	
FM L/R Mix Ratio	6.7 μs	—	—	—	—	—	—	—	—	—	—	—	—	—	—	—	—	—	
	6.4 μs	—	—	—	—	—	—	—	—	—	—	—	—	—	—	—	—	—	
	8.5 dB	—	—	—	—	—	—	—	—	—	—	—	—	—	—	—	—	—	
	10 dB	○	○	○	○	○	○	○	○	○	○	○	○	○	○	○	○	○	
TSW.1 (7pin : WE)	12 dB	—	—	—	—	—	—	—	—	—	—	—	—	—	—	—	—	—	
	14 dB	—	—	—	—	—	—	—	—	—	—	—	—	—	—	—	—	—	
	TSW.2 (AUX MUTE)	(A)	○	○	○	○	○	○	○	○	○	○	○	○	○	○	○	○	○
		B	—	—	—	—	—	—	—	—	—	—	—	—	—	—	—	—	—
	TSW.3 (L.O.(L))	(A) : Off	○	○	○	○	○	○	○	○	○	○	○	○	○	○	○	○	○
		B : ON	—	—	—	—	—	—	—	●	●	○	○	○	○	○	○	○	○
	TSW.4 (L.O.(R))	(A)	○	○	○	○	○	○	○	○	○	○	○	○	○	○	○	○	○
		B	—	—	—	—	●	●	●	—	—	—	—	—	—	—	—	—	—
	TSW.5 (32pin : WE)	(A)	○	○	○	○	○	○	○	○	○	○	○	○	○	○	○	○	○
		B	—	—	—	—	—	—	—	—	—	—	—	—	—	—	—	—	—
	TSW.A (36pin)	A	—	—	—	—	—	—	—	—	—	—	●	—	—	—	—	—	—
		(C)	○	○	○	○	○	○	○	○	○	○	○	○	○	○	○	○	○
TSW.B (30pin)	B	—	—	—	—	—	—	—	—	—	—	—	●	—	—	○	○	○	
	L	—	—	—	—	—	—	—	—	—	—	—	—	—	—	—	—	—	
TSW.C (27pin)	(C)	○	○	○	○	○	○	○	○	○	○	○	○	○	○	○	○	○	
	R	—	—	—	—	—	—	—	—	—	—	—	●	●	●	—	—	—	
	(A)	○	○	○	○	○	○	○	○	○	○	○	○	○	○	○	○	○	
	B	—	—	—	—	—	—	—	—	—	—	—	—	—	—	—	—	—	

ITEM		9-3	9-4	9-5	10-1	10-2	11-1	12-1	12-2	12-3	12-4	12-5	12-6	12-7	12-8	13-1	13-2	13-3	
SA No. 0	EE / Rec / PB	EE	-	-	-	-	-	-	-	-	-	-	-	-	-	-	-	-	
		Rec	-	-	-	-	-	-	-	-	-	-	-	-	-	-	-	-	
		PB	●	●	●	●	●	●	●	●	●	●	●	●	●	●	●	●	●
	Mute	ON	-	-	-	-	-	-	-	-	-	-	-	-	-	-	-	-	-
		Off	○	○	○	○	○	○	○	○	○	○	○	○	○	○	○	○	○
	Rec Norm Out Select	Mix	○	○	○	○	○	○	○	○	○	○	○	○	○	○	○	○	○
		Dual	-	-	-	-	-	-	-	-	-	-	-	-	-	-	-	-	-
	Hi-Fi Select	Line.3 (L)	-	-	-	-	-	-	-	-	-	-	-	-	-	-	-	-	-
		TV	○	○	○	○	○	○	○	○	○	○	○	○	○	○	○	○	○
		Line.1	-	-	-	-	-	-	-	-	-	-	-	-	-	-	-	-	-
		Line.2	-	-	-	-	-	-	-	-	-	-	-	-	-	-	-	-	-
	Log / J.Clock	Line.3	-	-	-	-	-	-	-	-	-	-	-	-	-	-	-	-	-
Log		○	○	○	○	○	○	○	○	○	○	○	○	○	○	○	○	○	
SA No. 1	Output Select	Just Clock	-	-	-	-	-	-	-	-	-	-	-	-	-	-	-	-	
		Stereo	○	○	○	○	○	○	○	○	○	○	○	○	○	○	○	○	○
		Hi-Fi (L)	-	-	-	-	-	-	-	-	-	-	-	-	-	-	-	-	-
		Hi-Fi (R)	-	-	-	-	-	-	-	-	-	-	-	-	-	-	-	-	-
		Hi (LR) + Norm	-	-	-	-	-	-	-	-	-	-	-	-	-	-	-	-	-
		Hi (L) + Norm	-	-	-	-	-	-	-	-	-	-	-	-	-	-	-	-	-
		Hi (R) + Norm	-	-	-	-	-	-	-	-	-	-	-	-	-	-	-	-	-
		Norm	-	-	-	-	-	-	-	-	-	-	-	-	-	-	-	-	-
		Line.2 Stereo	-	-	-	-	-	-	-	-	-	-	-	-	-	-	-	-	-
	EVR	Line.2 (L)	-	-	-	-	-	-	-	-	-	-	-	-	-	-	-	-	-
		Line.2 (R)	-	-	-	-	-	-	-	-	-	-	-	-	-	-	-	-	-
		Line.3 Stereo	-	-	-	-	-	-	-	-	-	-	-	-	-	-	-	-	-
	BPF	Line.3 (L)	-	-	-	-	-	-	-	-	-	-	-	-	-	-	-	-	-
		Line.3 (R)	-	-	-	-	-	-	-	-	-	-	-	-	-	-	-	-	-
	Auto BPF Request	Through	○	○	○	○	○	○	○	○	○	○	○	○	○	○	○	○	○
		ALC	-	-	-	-	-	-	-	-	-	-	-	-	-	-	-	-	-
	Mod f ₀ / BPF	Manual	-	-	-	-	-	-	-	-	-	-	-	-	-	-	-	-	-
		Auto	○	○	○	○	○	○	○	○	○	○	○	○	○	○	○	○	○
NTSC		○	○	○	○	○	○	●	●	●	●	●	●	●	●	●	●	●	
PAL		-	-	-	-	-	-	-	-	-	-	-	-	-	-	-	-	-	
PB FM Gain	0dB	○	○	○	○	○	○	○	○	○	○	○	○	○	○	○	○	○	
	3dB	-	-	-	-	-	-	-	-	-	-	-	-	-	-	-	-	-	
PB FM AGC (L / R)	R-ch	○	○	○	○	○	○	○	○	○	○	○	○	○	○	○	○	○	
	L-ch	-	-	-	-	-	-	-	-	-	-	-	-	-	-	-	-	-	
SW N.C. Pulse Width	11.6 μs	-	-	-	-	-	-	-	-	-	-	-	-	-	-	-	-	-	
	10.0 μs	-	-	-	-	-	-	-	-	-	-	-	-	-	-	-	-	-	
	8.5 μs	-	-	-	-	-	-	-	-	-	-	-	-	-	-	-	-	-	
	7.8 μs	-	-	-	-	-	-	-	-	-	-	-	-	-	-	-	-	-	
	7.4 μs	○	○	○	○	○	○	○	○	○	○	○	○	○	○	○	○	○	
	7.0 μs	-	-	-	-	-	-	-	-	-	-	-	-	-	-	-	-	-	
	6.7 μs	-	-	-	-	-	-	-	-	-	-	-	-	-	-	-	-	-	
FM L / R Mix Ratio	6.4 μs	-	-	-	-	-	-	-	-	-	-	-	-	-	-	-	-	-	
	8.5 dB	-	-	-	-	-	-	-	-	-	-	-	-	-	-	-	-	-	
	10 dB	○	○	○	○	○	○	○	○	○	○	○	○	○	○	○	○	○	
	12 dB	-	-	-	-	-	-	-	-	-	-	-	-	-	-	-	-	-	
TSW.1 (7pin : WE)	14 dB	-	-	-	-	-	-	-	-	-	-	-	-	-	-	-	-	-	
	(A)	○	○	○	○	○	○	○	○	○	○	○	○	○	○	○	○	○	
	B	-	-	-	-	-	-	-	-	-	-	-	-	-	-	-	-	-	
	(A) : Off	○	○	○	○	○	○	○	○	○	○	○	○	○	○	○	○	○	○
	B : ON	-	-	-	-	-	-	-	-	-	-	-	-	-	-	-	-	-	
	(A)	○	○	○	○	○	○	○	○	○	○	○	○	○	○	○	○	○	
	B	-	-	-	-	-	-	-	-	-	-	-	-	-	-	-	-	-	
	(A)	○	○	○	○	○	○	○	○	○	○	○	○	○	○	○	○	○	
	B	-	-	-	-	-	-	-	-	-	-	-	-	-	-	-	-	-	
	(A)	○	○	○	○	○	○	○	○	○	○	○	○	○	○	○	○	○	
	B	-	-	-	-	-	-	-	-	-	-	-	-	-	-	-	-	-	
	(A)	○	○	○	○	○	○	○	○	○	○	○	○	○	○	○	○	○	
(C)	○	○	○	○	○	○	○	○	○	○	○	○	○	○	○	○	○		
B	-	-	-	-	-	-	-	-	-	-	-	-	-	-	-	-	-		
(A)	○	○	○	○	○	○	○	○	○	○	○	○	○	○	○	○	○		
(C)	○	○	○	○	○	○	○	○	○	○	○	○	○	○	○	○	○		
R	-	-	-	-	-	-	-	-	-	-	-	-	-	-	-	-	-		
(A)	○	○	○	○	○	○	○	○	○	○	○	○	○	○	○	○	○		
B	-	-	-	-	-	-	-	-	-	-	-	-	-	-	-	-	-		

ITEM		13-4	13-5	13-6	13-7	13-8	14-1	14-2	15-1	15-2	15-3	15-4	15-5	15-6	15-7	15-8	
SA No. 0	EE / Rec / PB	EE	-	-	-	-	-	-	-	-	-	-	-	-	-	-	
		Rec	-	-	-	-	-	-	-	-	-	-	-	-	-	-	-
		PB	●	●	●	●	●	●	●	●	●	●	●	●	●	●	●
	Mute	ON	-	-	-	-	-	-	-	-	-	-	-	-	-	-	-
		Off	○	○	○	○	○	○	○	○	○	○	○	○	○	○	○
	Rec Norm Out Select	Mix	○	○	○	○	○	○	○	○	○	○	○	○	○	○	○
		Dual	-	-	-	-	-	-	-	-	-	-	-	-	-	-	-
		Line.3 (L)	-	-	-	-	-	-	-	-	-	-	-	-	-	-	-
	Hi-Fi Select	TV	○	○	○	○	○	○	○	○	○	○	○	○	○	○	○
		Line.1	-	-	-	-	-	-	-	-	-	-	-	-	-	-	-
Line.2		-	-	-	-	-	-	-	-	-	-	-	-	-	-	-	
Line.3		-	-	-	-	-	-	-	-	-	-	-	-	-	-	-	
Log / J.Clock	Log	○	○	○	○	○	○	○	○	○	○	○	○	○	○	○	
	Just Clock	-	-	-	-	-	-	-	-	-	-	-	-	-	-	-	
SA No. 1	Output Select	Stereo	○	○	○	○	○	○	○	○	○	○	○	○	○	○	○
		Hi-Fi (L)	-	-	-	-	-	-	-	-	-	-	-	-	-	-	-
		Hi-Fi (R)	-	-	-	-	-	-	-	-	-	-	-	-	-	-	-
		Hi (LR) + Norm	-	-	-	-	-	-	-	-	-	-	-	-	-	-	-
		Hi (L) + Norm	-	-	-	-	-	-	-	-	-	-	-	-	-	-	-
		Hi (R) + Norm	-	-	-	-	-	-	-	-	-	-	-	-	-	-	-
		Norm	-	-	-	-	-	-	-	-	-	-	-	-	-	-	-
		Line.2 Stereo	-	-	-	-	-	-	-	-	-	-	-	-	-	-	-
		Line.2 (L)	-	-	-	-	-	-	-	-	-	-	-	-	-	-	-
		Line.2 (R)	-	-	-	-	-	-	-	-	-	-	-	-	-	-	-
	Line.3 Stereo	-	-	-	-	-	-	-	-	-	-	-	-	-	-	-	
	Line.3 (L)	-	-	-	-	-	-	-	-	-	-	-	-	-	-	-	
	Line.3 (R)	-	-	-	-	-	-	-	-	-	-	-	-	-	-	-	
	EVR	Through	○	○	○	○	○	○	○	○	○	○	○	○	○	○	○
ALC		-	-	-	-	-	-	-	-	-	-	-	-	-	-	-	
Manual		-	-	-	-	-	-	-	-	-	-	-	-	-	-	-	
BPF	Auto	○	○	○	○	○	○	○	○	○	○	○	○	○	○	○	
	Manual	-	-	-	-	-	-	-	-	-	-	-	-	-	-	-	
Auto BPF Request	Off	○	○	○	○	○	○	○	○	○	○	○	○	○	○	○	
	ON	-	-	-	-	-	-	-	-	-	-	-	-	-	-	-	
SA No. 2	Mod f ₀ / BPF	NTSC	●	●	●	●	●	●	●	●	●	●	●	●	●	●	
		PAL	-	-	-	-	-	-	-	-	-	-	-	-	-	-	-
	PB FM Gain	0dB	○	○	○	○	○	●	●	●	●	-	●	●	●	●	●
		3dB	-	-	-	-	-	-	-	-	●	-	-	-	-	-	-
	PB FM AGC (L / R)	R-ch	-	○	○	○	○	-	-	●	-	-	●	●	●	●	●
		L-ch	○	-	-	-	-	●	●	-	●	●	-	-	●	●	●
	SW N.C. Pulse Width	11.6 μs	-	-	-	-	-	-	-	-	-	-	-	-	-	-	-
		10.0 μs	-	-	-	-	-	-	-	-	-	-	-	-	-	-	-
		8.5 μs	-	-	-	-	-	-	-	-	-	-	-	-	-	-	-
		7.8 μs	-	-	-	-	-	-	-	-	-	-	-	-	-	-	-
7.4 μs		○	○	○	○	○	○	○	○	○	○	○	○	○	○	○	
7.0 μs		-	-	-	-	-	-	-	-	-	-	-	-	-	-	-	
6.7 μs		-	-	-	-	-	-	-	-	-	-	-	-	-	-	-	
FM L / R Mix Ratio	6.4 μs	-	-	-	-	-	-	-	-	-	-	-	-	-	-	-	
	8.5 dB	-	-	-	-	-	-	-	-	-	-	-	-	-	-	-	
	10 dB	○	○	○	○	○	○	○	○	○	○	○	○	○	○	○	
	12 dB	-	-	-	-	-	-	-	-	-	-	-	-	-	-	-	
TWS	TWS.1 (7pin : WE)	(A)	○	○	○	○	○	○	○	○	○	○	○	○	○	○	
		B	-	-	-	-	-	-	-	-	-	-	-	-	-	-	
	TWS.2 (AUX MUTE)	(A) : Off	○	○	○	○	○	○	○	○	○	○	○	○	○	○	○
		B : ON	-	-	-	-	-	-	-	-	-	-	-	-	-	-	-
	TWS.3 (L.O.(L))	(A)	○	○	○	○	○	○	○	○	○	○	○	○	○	○	○
		B	-	-	-	-	-	-	-	-	-	-	-	-	-	-	-
	TWS.4 (L.O.(R))	(A)	○	○	○	○	○	○	○	○	○	○	○	○	○	○	○
		B	-	-	-	-	-	-	-	-	-	-	-	-	-	-	-
	TWS.5 (32pin : WE)	(A)	○	○	○	○	○	○	○	○	○	○	○	○	○	○	○
		B	-	-	-	-	-	-	-	-	-	-	-	-	-	-	-
	TWS.A (36pin)	A	-	●	●	●	●	-	-	-	-	-	-	-	-	-	-
		(C)	-	-	-	-	-	-	-	-	-	-	-	-	-	-	-
		B	●	-	-	-	-	-	-	-	-	-	-	-	-	-	-
	TWS.B (30pin)	L	-	-	-	-	-	-	-	-	-	-	-	-	-	-	-
(C)		○	○	○	○	○	○	○	○	○	○	○	○	○	○	○	
R		-	-	-	-	-	-	-	-	-	-	-	-	-	-	-	
TWS.C (27pin)	(A)	●	●	●	●	●	-	-	-	-	-	-	-	-	-	-	
	B	-	-	-	-	-	-	-	-	-	-	-	-	-	-	-	

● : Required, ○ : Recommended

APPLICATION CIRCUIT

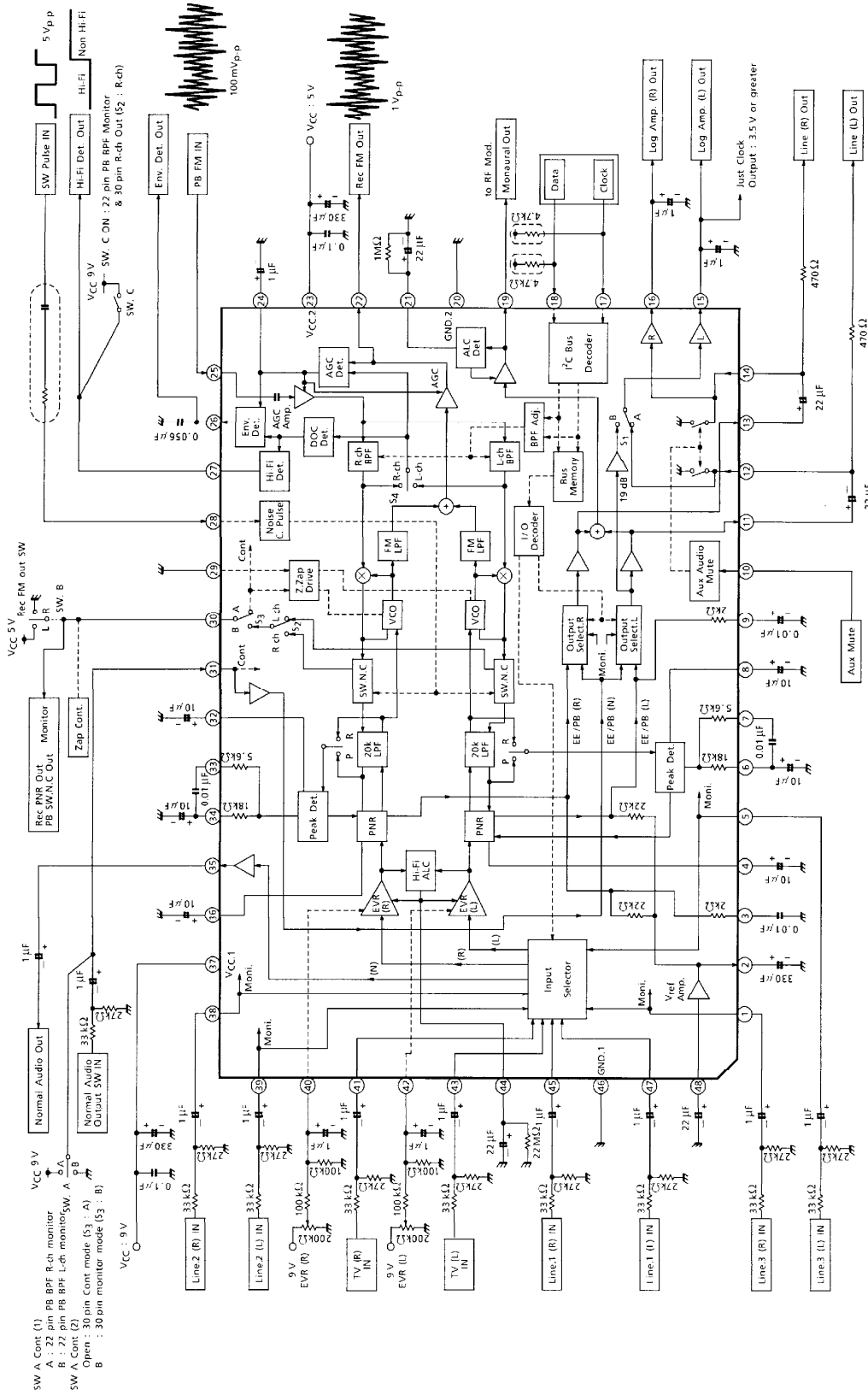

TA1246F / AF-73

OUTLINE DRAWING
QFP48-P-1014-0.80

Unit : mm

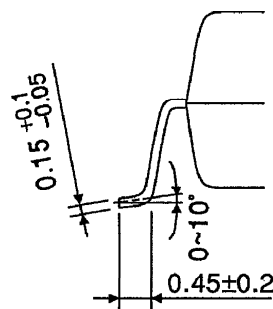
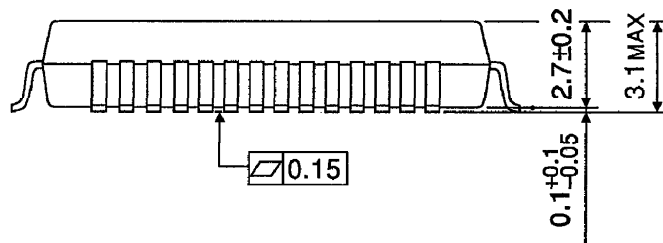
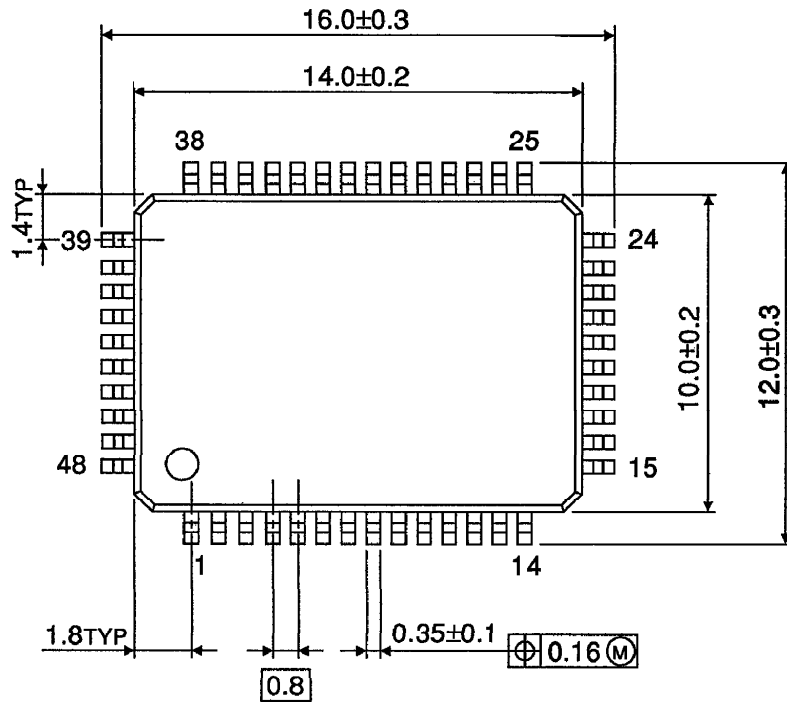

Weight : 1.47 g (Typ.)