



Design Example Report

Title	<i>9W power supply using TNY267P</i>
Specification	Input: 85 – 265 VAC Output: 5V/0.75A, 3.3V/0.5A, 12V/100mA, -12V/10 mA, -23V/10 mA, Floating 3V/100 mA
Application	DVD Player
Author	Power Integrations Applications Department
Document Number	DER-7
Date	February 4, 2004
Revision	1.0

Summary and Features

- Low cost
- no Y-cap
- no common-mode choke
- low EMI even with output grounded
- good output cross-regulation even with no TL431
- ~ 200 mW input power with low-cost “DC Switch”

The products and applications illustrated herein (including circuits external to the products and transformer construction) may be covered by one or more U.S. and foreign patents or potentially by pending U.S. and foreign patent applications assigned to Power Integrations. A complete list of Power Integrations' patents may be found at www.powerint.com.

Table Of Contents

- 1 Introduction..... 3
- 2 Photograph..... 4
- 3 Power Supply Specification 5
- 4 Schematic..... 6
- 5 Circuit Description 7
 - 5.1 Input Rectification..... 7
 - 5.2 Auxiliary Bias Supply..... 7
 - 5.3 Output Voltage Sensing, Feedback and DC switch..... 7
- 6 PCB Layout 7
- 7 Bill Of Materials 8
- 8 Transformer Specification..... 9
 - 8.1 Electrical Diagram 9
 - 8.2 Electrical Specifications..... 9
 - 8.3 Materials..... 10
 - 8.4 Transformer Build Diagram 10
 - 8.5 Copper Foil Preparation 11
 - 8.6 Winding Instructions..... 11
- 9 Performance Data 12
 - 9.1 Standby Input Power during DC switch operation 12
 - 9.2 Cross Regulation..... 13
- 10 Thermal Performance 13
- 11 Minimum Operating Voltage and peak power margin 13
- 12 Output ripple and Noise Waveforms 14
- 13 Conducted EMI 17
- 14 Revision History 19

Important Notes:

Although this board is designed to satisfy safety isolation requirements, the engineering prototype has not been agency approved. Therefore, all testing should be performed using an isolation transformer to provide the AC input to the prototype board.

Design Reports contain a power supply design specification, schematic, bill of materials, and transformer documentation. Performance data and typical operation characteristics are included. Typically only a single prototype has been built.



1 Introduction

This document is an engineering report describing a 9W (10.5W peak) multiple output power supply utilizing a TNY267P for a DVD player.

This design is low cost and meets EMI with no common-mode choke, no X-cap, and no Y-cap. This is possible with TinySwitch-II because of its built-in frequency jitter.

Cross-regulation is tight in spite of having a simple low-cost zener regulation scheme. This is possible with TinySwitch-II because of its unique feedback scheme.

A low-cost non-Safety rated “DC Switch” allows shutdown with ~200 mW consumption at 230 Vac. This is possible with TinySwitch-II because of its *EcoSmart* features.

This document contains the power supply specification, schematic, bill of materials, transformer documentation, printed circuit layout, and performance data.



2 Photograph

Note the following:

- Does not use common-mode choke, X-cap, nor Y-cap
- Uses little board space
- Uses small transformer: EE25L
- Uses small output capacitors
- Uses small output diodes
- Does not use TL431

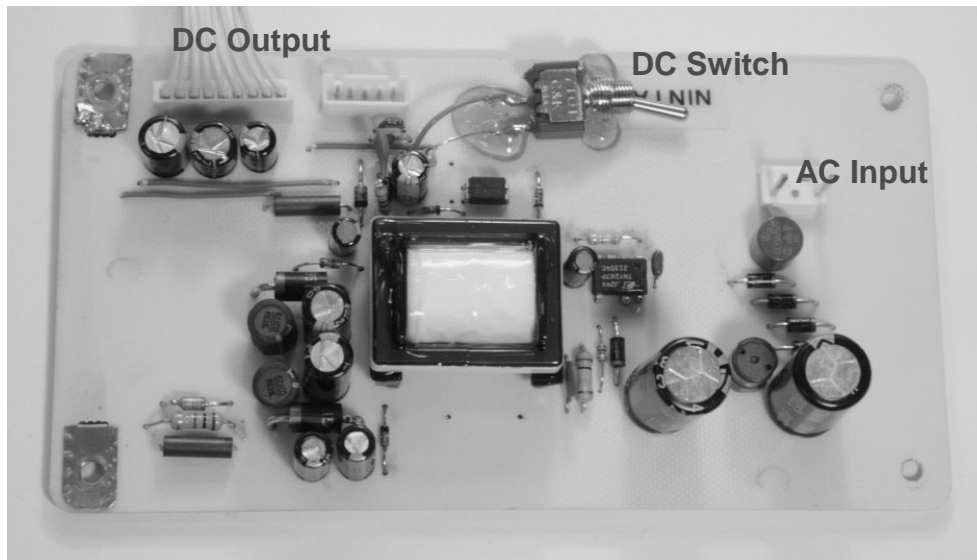

Figure 1 – Power Integrations PSU unit

3 Power Supply Specification

Description	Symbol	Min	Typ	Max	Units	Comment
Input						
Voltage	V_{IN}	85		265	VAC	2 Wire – no P.E.
Frequency	f_{LINE}	47	50/60	64	Hz	
No-load Input Power (230 VAC)				0.3	W	
Output						
Output Voltage 1	V_{OUT1}		3.3		V	20 MHz Bandwidth
Output Ripple Voltage 1	$V_{RIPPLE1}$			33	mV	
Output Current 1	I_{OUT1}		0.5	1.5	A	± 5%
Output Voltage 2	V_{OUT2}		5.0		V	
Output Ripple Voltage 2	$V_{RIPPLE2}$			50	mV	20 MHz Bandwidth
Output Current 2	I_{OUT2}		0.75	1.5	A	
Output Voltage 3	V_{OUT3}		12		V	20 MHz Bandwidth
Output Ripple Voltage 3	$V_{RIPPLE3}$			60	mV	
Output Current 3	I_{OUT3}		0.1	0.5	A	zener regulated
Output Voltage 4	V_{OUT4}		-12		V	
Output Ripple Voltage 4	$V_{RIPPLE4}$			60	mV	20 MHz Bandwidth
Output Current 4	I_{OUT4}		0.01		A	
Output Voltage 5	V_{OUT5}		-23		V	20 MHz Bandwidth
Output Ripple Voltage 5	$V_{RIPPLE5}$			400	mV	
Output Current 5	I_{OUT5}		0.01	.08	A	floating output for display
Output Voltage 6	V_{OUT6}		3.0		V	
Output Ripple Voltage 6	$V_{RIPPLE6}$			200	mV	20 MHz Bandwidth
Output Current 6	I_{OUT6}		0.1		A	
Total Output Power						
Continuous Output Power	P_{OUT}		9.0		W	
Peak Output Power	P_{OUT_PEAK}			10.5	W	
Efficiency	η		72		%	Measured at full load, 25 °C
Environmental						
Conducted EMI			Meets CISPR22B / EN55022B			
Ambient Temperature	T_{AMB}	0		40	°C	Free convection, sea level



4 Schematic

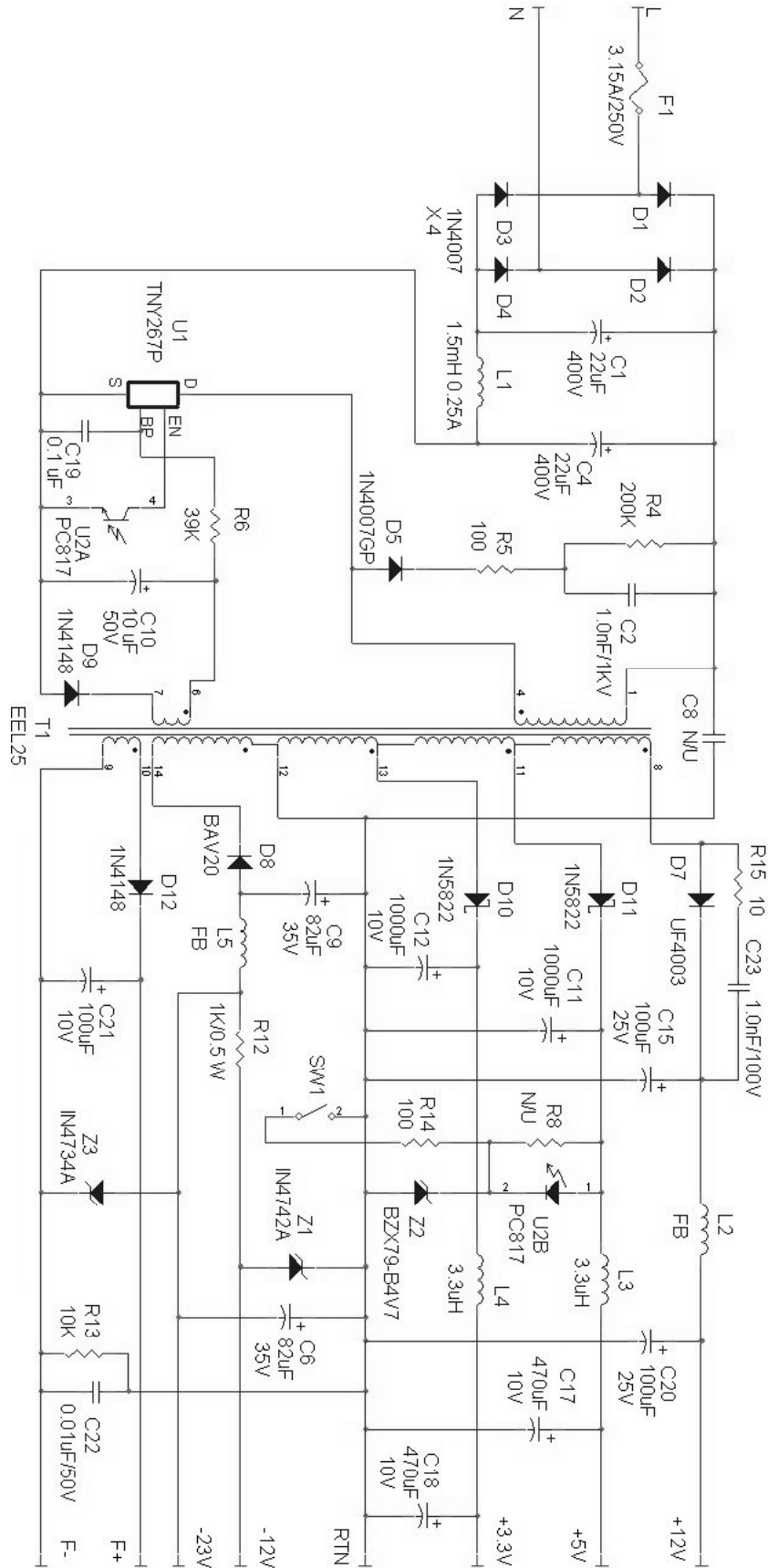

Figure 2 – Schematic.



5 Circuit Description

This circuit is configured as a flyback using the TNY267.

5.1 Input Rectification

AC input power is rectified by a full bridge, consisting of D1 through D4. The rectified DC is then filtered by the bulk storage capacitors C1 and C2. Inductor L1, C1 and C2 form a pi (π) filter, which attenuates conducted differential-mode EMI noise.

5.2 Auxiliary Bias Supply

The auxiliary bias supply circuit is made up of the primary-side transformer bias winding, diode D9, capacitor C10 and resistor R6. The bias voltage was given just enough current to disable the internal current source during “DC Switch” operation. In this case, the standby power consumption is minimized.

5.3 Output Voltage Sensing, Feedback and DC switch

The combined voltage drops of Zener diode Z2 and optocoupler set the main output voltage. TinySwitch-II feedback current is independent of load allowing tight output voltage tolerance with this simple Zener circuit. The operation of the TinySwitch allows the use of a “DC switch” (SW1) to put the power supply in a standby condition, with very low consumption. The DC switch does not need to be safety-rated, and thus is much lower cost than an equivalent AC switch. During DC Switch operation, the 5C output is regulated at 1V, and all other outputs are at 1/5th of normal output voltage. The DVD system load is very low during this output voltage condition. The net result is that the input power is ~200 mW at 230 Vac input. This is possible with TinySwitch-II because of its *EcoSmart* features.

6 PCB Layout

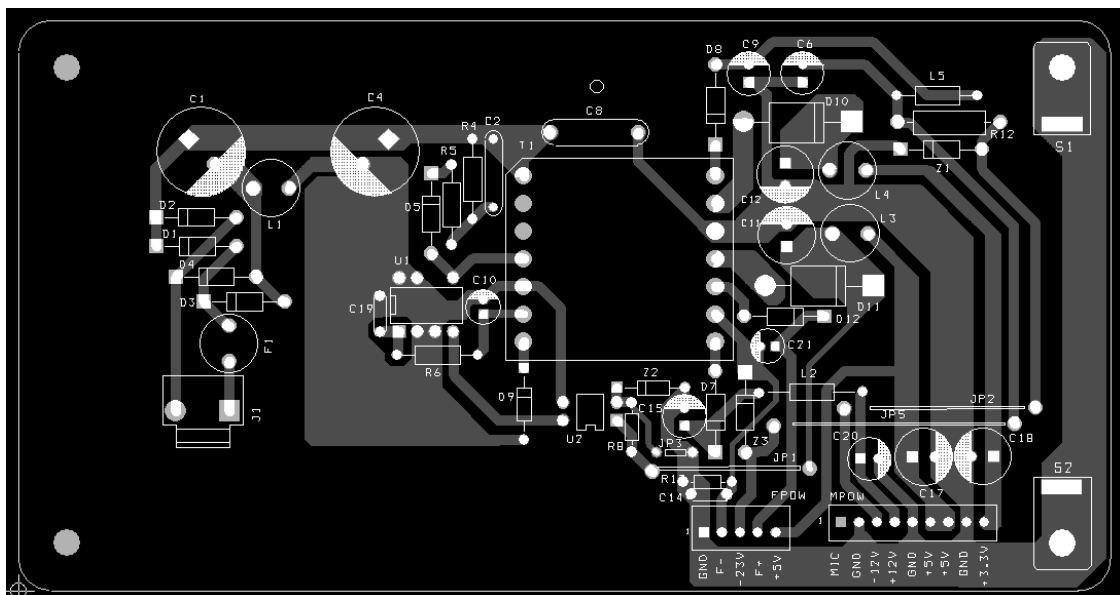

Figure 3 Printed Circuit Layout.



7 Bill Of Materials

Item	Qty	Reference	Description	P/N	Manufacturer
1	2	C1, C4	22 μ F, 400 V	KMG400VB22M	Nippon Chemi-Con
2	1	C2	1.0 nF, 1 kV, ceramic Z5U dielectric	Any	
3	2	C6, C9	82 μ F, 35 V	KMG35VB82M	Nippon Chemi-Con
4	1	C10	10 μ F, 50 V	KMG50VB10M	Nippon Chemi-Con
5	2	C17, C18	470 μ F, 10 V, low esr	KY10VB470MK30	Nippon Chemi-Con
6	2	C11 C12	1000 μ F, 10 V, 60 m Ω	KY10VB1000MJ16	Nippon Chemi-Con
7	1	C19	0.1 μ F, 50 V, ceramic Z5U dielectric	Any	
8	2	C15, C20	100 μ F, 25 V, low esr	KZE25VB100MJ16	Nippon Chemi-Con
9	1	C21	100 μ F, 10 V low esr	KMG10VB100M	Nippon Chemi-Con
10	1	C22	0.01 μ F, 50 V ceramic	Any	
11	1	C23	1000 pF, 100V ceramic	Any	
12	4	D1, D2, D3, D4	1 A, 600 V	1N4007	Any
13	1	D5	1 A, 600 V, Glass Passivated	1N4007GP	Vishay / Any
14	1	D7	UF4003	Any	
15	2	D9, D12	1N4148	Any	
16	1	D8	BAV20	Any	
17	2	D10, D11	1N5822	Any	
18	1	F1	3.15 A, 250 VAC	Any	
19	1	L1	1.5 mH 0.25 A	SBC3-152-251	Tokin, or equiv.
20	1	L3, L4	3.3 μ H, 2.66 A	822LY-3R3M	Toko, or equiv.
21	2	L2, L5	Ferrite Bead	Any	
22	2	R5, R14	100 Ω , 1/4 W, 5%	Any	
23	1	R6	39 k Ω , 1/4 W, 5%	Any	
24	1	R4	200 K Ω , 1/2 W, 5%	Any	
25	1	R13	10 k Ω , 1/4 W, 5%	Any	
26	1	R12	1.0 k Ω , 1/2W 5%	Any	
27	1	R15	10 Ω , 1/4W, 5%	Any	
28	1	Z1	12V, 1/2 W, 5%	1N4742	Any
29	1	Z2	4.7V, 1/4 W, 2%	BZX79-B4V7	Any
30	1	Z3	5.6V, 1/2 W, 5%	1N4734A	Any
31	1	T1	EEL25	Custom	Any
32	1	U1	<i>TinySwitch-II</i>	TNY267P	Power Integrations
33	1	U2B, U2A	PC817A	Any	Isocom / Any
34	1	PCB		Any	
35	1	SW1	DC switch	Any	



8 Transformer Specification

8.1 Electrical Diagram

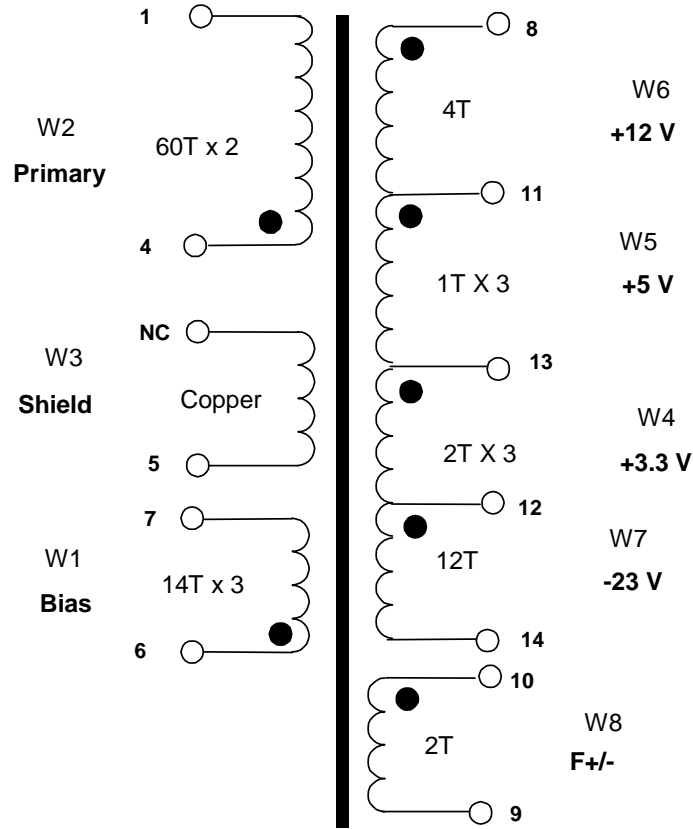

Figure 4 –Transformer Electrical Diagram

8.2 Electrical Specifications

Electrical Strength	1 second, 60 Hz, from pins 1-7 to pins 8-14	3000 VAC
Primary Inductance	Pins 1-4, all other windings open. Measured at 132 kHz, 1 VRMS	1.43 mH +/- 10%
Resonant Frequency	Pin 1-4, all other windings open	300 kHz (Min.)
Primary Leakage Inductance	Pins 1-4, with pins 8-14 shorted. Measured at 132 kHz, 1 VRMS	20 μ H (Max.)

8.3 Materials

Item	Description
[1]	Core: EEL25, TDK Gapped for AL of 392 nH/T ²
[2]	Bobbin: EEL25 Vertical 14 pins
[3]	Magnet Wire: # 32 AWG
[4]	Magnet Wire: #28 AWG
[5]	Magnet Wire: #26 AWG
[6]	Copper Foil 0.12 mm thick, 16 mm wide.
[7]	Tape: 3M 1298 Polyester Film, 16.1 mm wide
[8]	Tape: 3M 1298 Polyester Film, 22.1 mm wide
[9]	Margin tape: 3M # 44 Polyester web. 3.0 mm wide
[10]	Teflon
[11]	Copper Tape 2.0 mils thick, 16 mm wide.
[12]	Varnish

8.4 Transformer Build Diagram

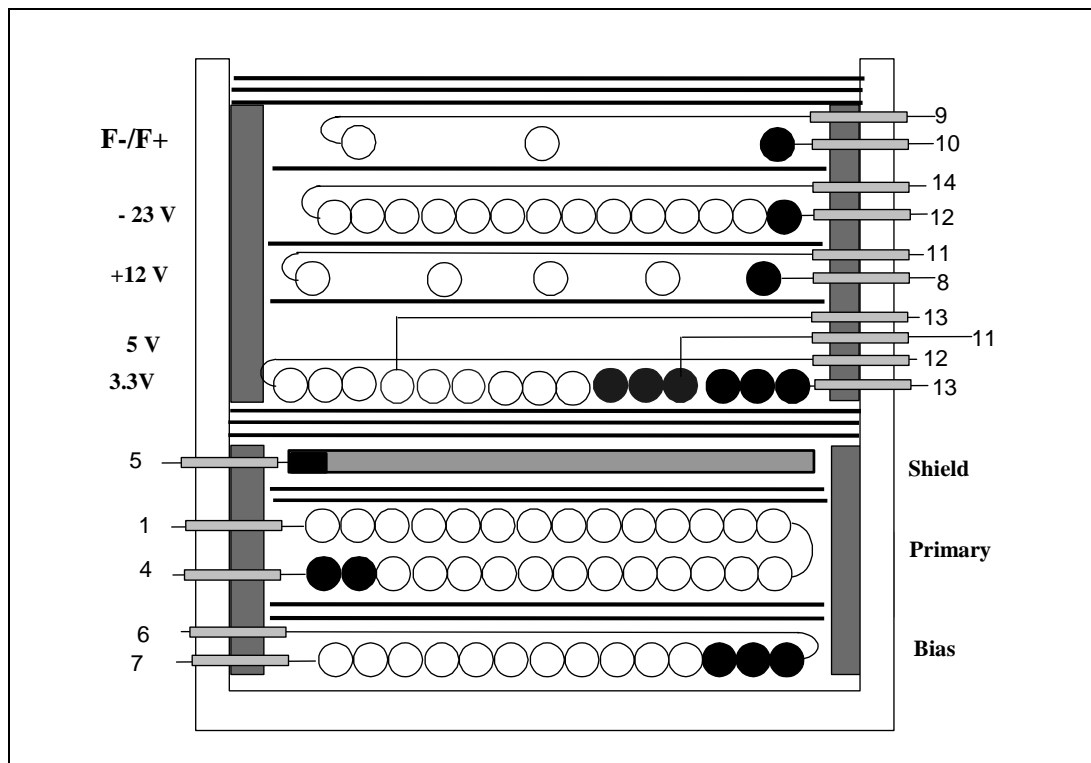

Figure 5 – Transformer Build Diagram.



8.5 Copper Foil Preparation

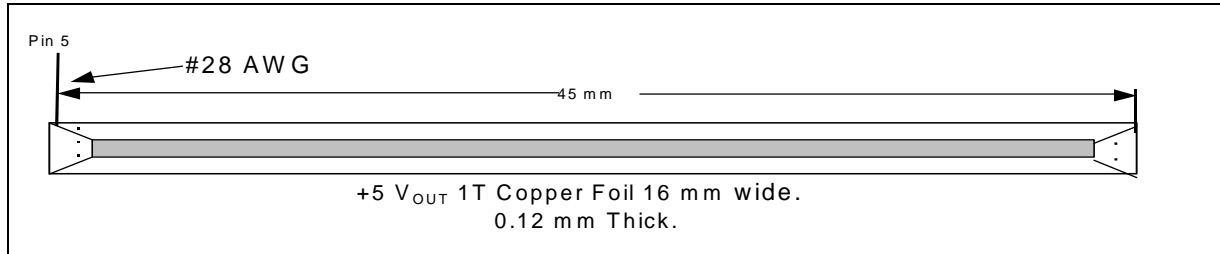

Figure 6 – Foil Winding Preparation Diagram.

8.6 Winding Instructions

Bobbin Set Up Orientation	Set up the bobbin with its pin1 to pin7 oriented to the left hand side.
Margin Tape	Apply 3.0 mm margin at each side of bobbin using item [9]. Match combined height of primary, shield and bias windings.
W1 Bias Winding	Start at pin 10 temporarily. Wind 14 trifilar turns of item [4] from right to left. Wind tightly and uniformly across entire width of bobbin. Finish at pin 7 using item [10] at the finish leads. Flip the starting lead over to pin 6 using item [10] at the finish lead.
Basic Insulation	Apply 2 layers of tape item [7]
W2 Two Layers Primary Winding	Start on pin 4 using item [10] at the start leads. Wind 30 bifilar turns of item [3] from left to right. Wind another 30 turns from right to left in second layer. Finish on pin 1 using item [10] at the finish leads.
Basic Insulation	Apply 2 layers of tape item [7]
W3 Copper Shield	Start on pin 5 using item [10] at the start leads. Wind 1 turns of copper shield shown in figure 6. Apply next step tape item[8] first before close this winding to avoid copper shortage.
Basic Insulation	Apply 3 layers of tape item [8]
Margin Tape	Apply 3.0 mm margin at each side of bobbin using item [9]. Match combines height of secondary windings.
W4 3.3 V Winding.	Start at pin 13 using item [10] at the start leads. Wind 2 trifilar turns of item [5]. The wires should be tightly and uniformly wound spread across the bobbin width. Finish on pin 12 using item [4] at the finish leads.
W5 +5V Winding	Start on pin 11 using item [10] at the start leads. Wind 1 trifilar turn of item [5]. Wind the wire between 3.3V windings. Finish on pin 13 using item [10] at the finish leads.
Basic Insulation	Apply one layer of tape item [7]
W6 +12 Winding	Start at pin 8 using item [10] at the start leads. Wind 4 turns of item [4]. Wind uniformly spread across the bobbin. Finish at pin 11 using item [10] at the finish leads.
Basic Insulation	Apply one layer of tape item [7]
W7 -23 V Winding	Start at pin 12 using item [10] at the start leads. Wind 12 turns of item [4]. Wind from right to left in a uniform and tightly wound spread across the bobbin width. Finish on pin 14 using item [4] at the finish leads.
W8 F- / F+ Winding	Start at pin 10 using item [10] at the start leads. Wind 2 turns of item [4]. Finish at pin 9 using item [10] at the finish leads.
Outer Insulation	3 Layers of tape [8] for insulation.
Core Assembly	Assemble and secure core halves. Item [1]
Final Varnish	Dip varnish uniformly in item [12]



9 Performance Data

All measurements performed at room temperature, 60 Hz input frequency.

9.1 Standby Input Power during DC switch operation

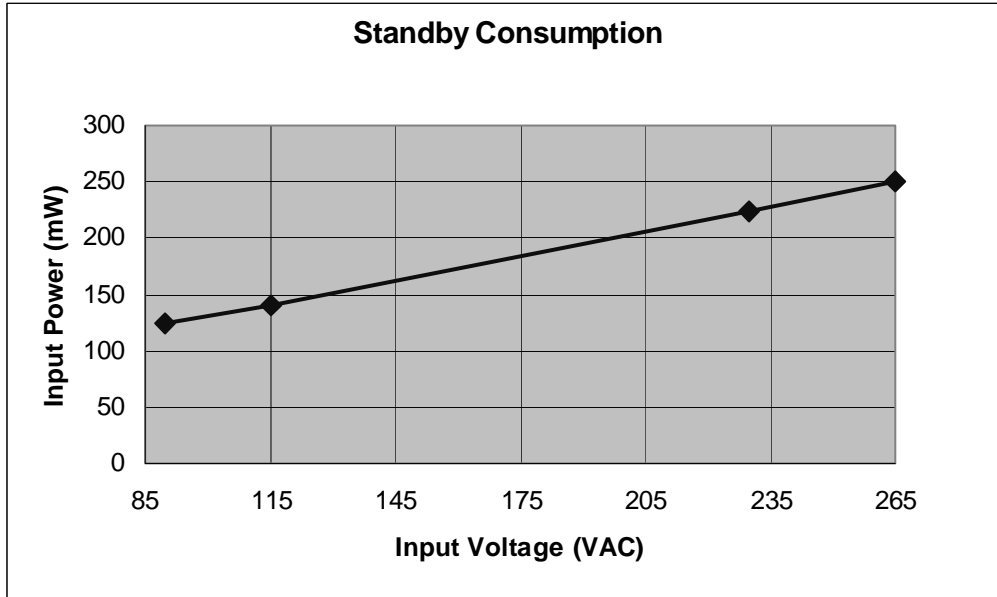

Figure 7- Standby Input Power vs. Input Line Voltage



9.2 Cross Regulation

Minimum and maximum output voltages were recorded, while cycling the unit on/off, start/stop, pause/run, chapter jump, and fast forward. The tests were done at room temperature, 115 VAC input. Note the tight regulation of the PI 3.3V output in spite of the low-cost, simple zener regulation. This is possible with TinySwitch-II because of its unique feedback scheme.

Output	Minimum	Maximum
3.3 V	3.288 V	3.468 V
5 V	5.08 V	5.24 V
+12 V	12.28 V	13.4V
-12 V	-11.68 V	-11.76 V
-23 V	-21.88 V	-24,08 V
F- / F+	2.24 V	2.744 V

10 Thermal Performance

Temperature of TOP267 during normal operation, case of DVD player closed.
Temperature rise is less than 30 °C.

Item	85 VAC	265 VAC
Ambient	25 °C	25 °C
<i>TinySwitch (267P)</i>	45.4 °C	52.1 °C

11 Minimum Operating Voltage and peak power margin

The unit is capable of starting and running as low as **68 VAC**. This indicates plenty of margin for the DVD player's peak power requirements, as flyback power supplies deliver less maximum power when the AC input voltage is low.



12 Output ripple and Noise Waveforms

The ripple and noise were measured during normal DVD operation at room temperature, 90 VAC input. Note the low output ripple and noise in spite of small output capacitors. The TinySwitch-II shows fast transient response because of its unique feedback scheme.

Measured Results

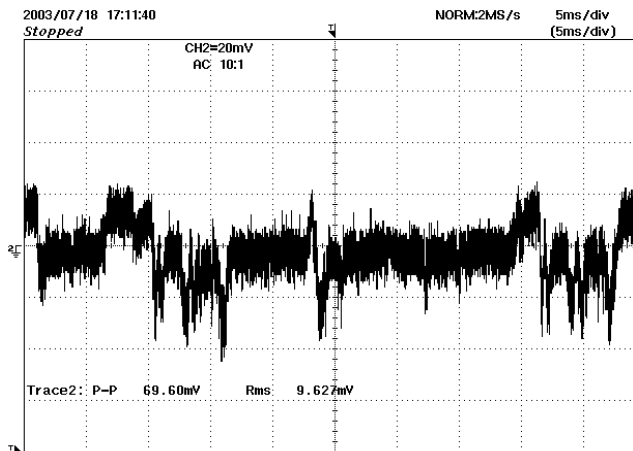

Figure 8: 3.3 V, 5 ms, 20 mV / div

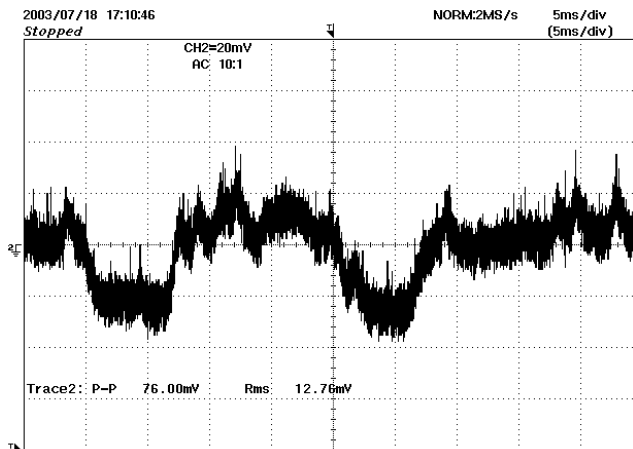

Figure 9: 5 V, 5 ms, 20 mV / div



Measured Results

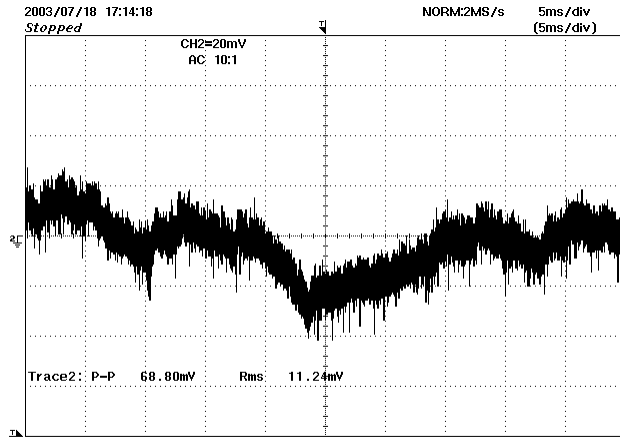

Figure 10: +12 V, 5 ms, 20 mV /div

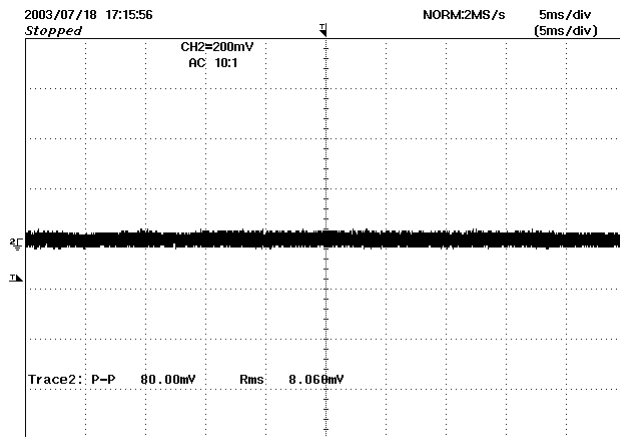

Figure 11: -12 V, 5 ms, 200 mV /div



Measured Results

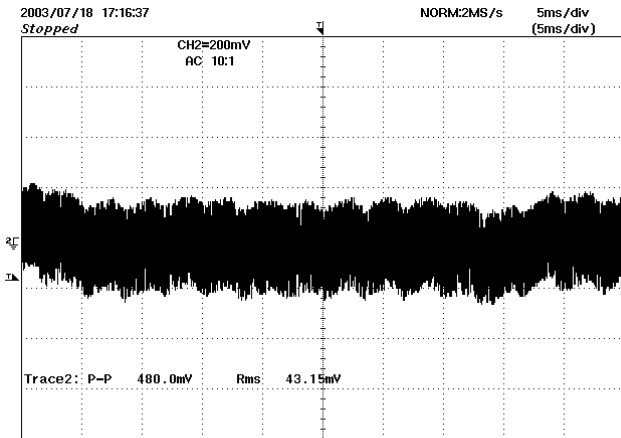

Figure 12: -23 V, 5 ms, 200 mV /div

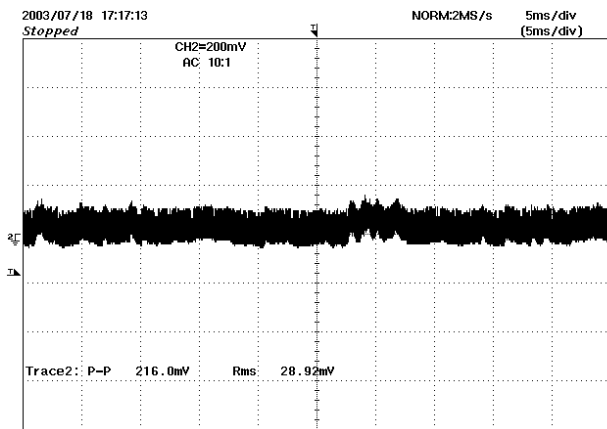

Figure 13: F- / F+, 5 ms, 200 mV /div



13 Conducted EMI

EMI was tested at room temperature, 230 VAC input, during normal operation. Note the very lower EMI (>12 dB margin), especially with *output grounded*, in spite of having *no common mode choke, no Y-cap, and no X-cap*. The excellent EMI is possible with TinySwitch-II because of its built-in frequency jitter.

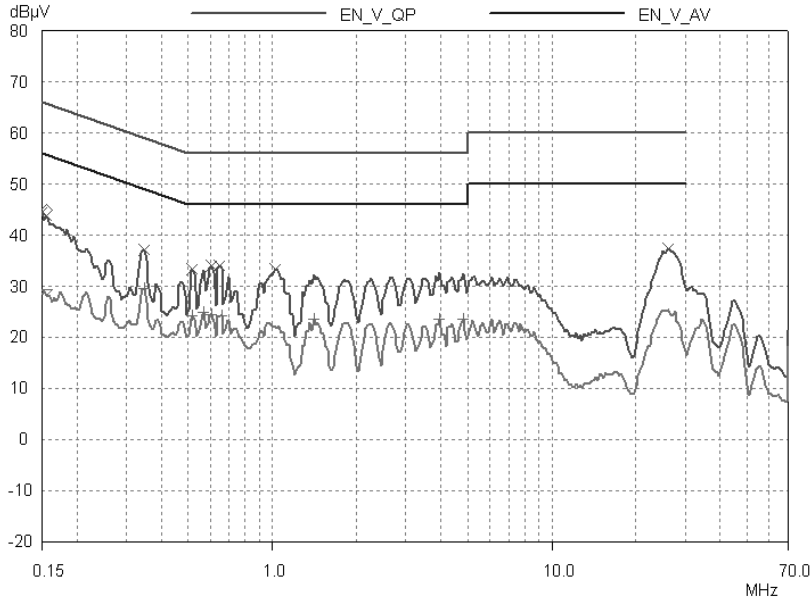

Figure 14 – Line, floating output

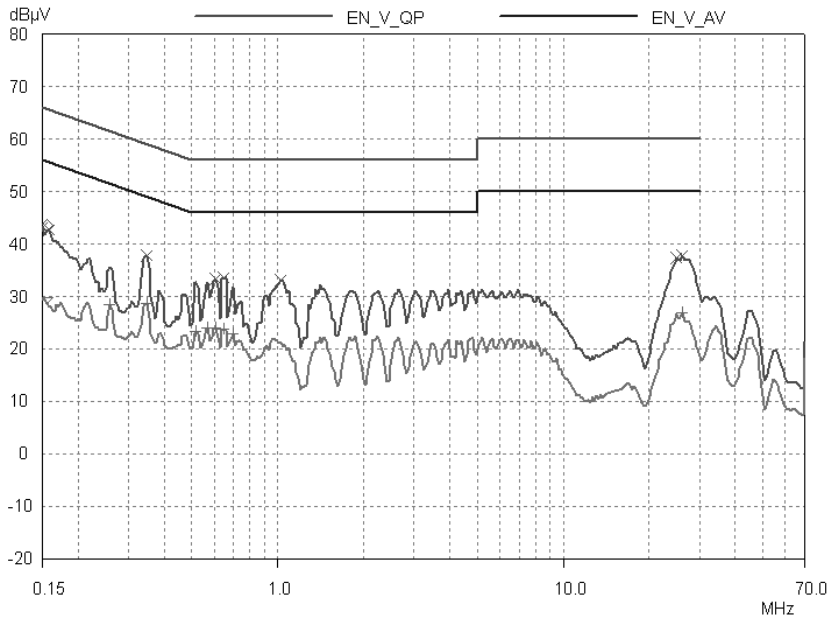

Figure 15 – Neutral, floating output



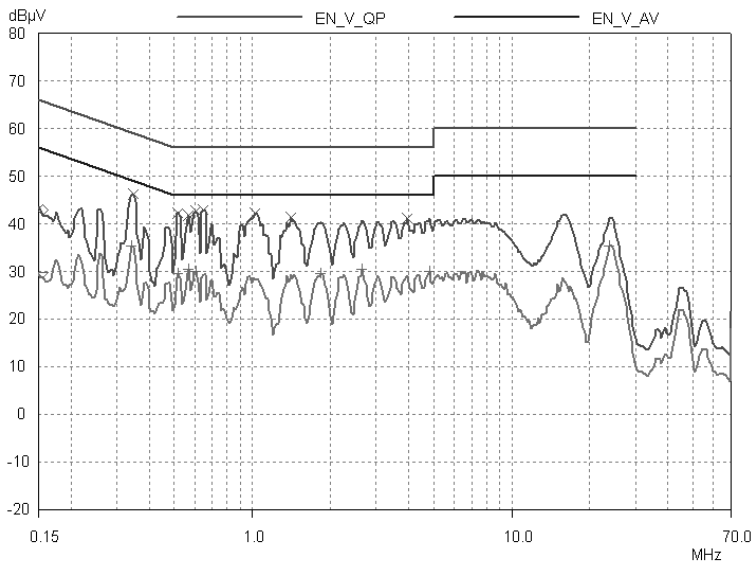

Figure 16 – Line, output grounded

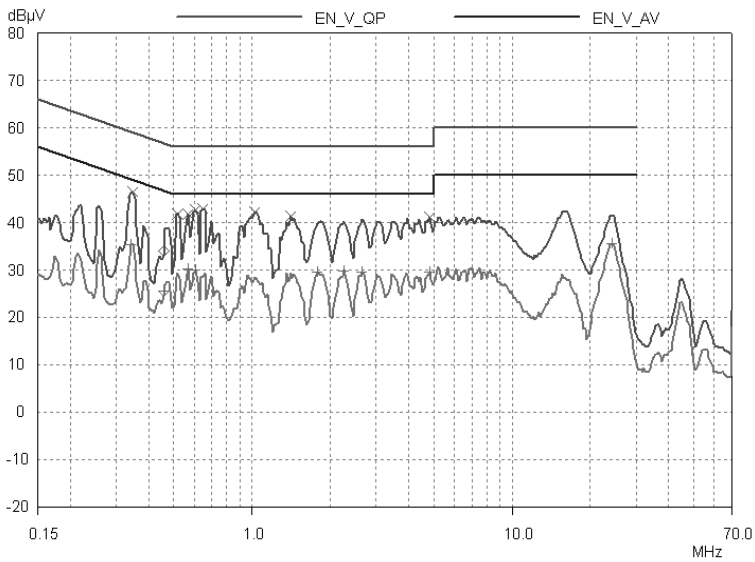

Figure 17 – Neutral, output grounded



14 Revision History

Date	Author	Revision	Description & changes	Reviewed
February 4, 2004	YG	1.0	First Release	AM/VC



For the latest updates, visit our Web site: www.powerint.com

Power Integrations reserves the right to make changes to its products at any time to improve reliability or manufacturability. Power Integrations does not assume any liability arising from the use of any device or circuit described herein, nor does it convey any license under its patent rights or the rights of others.

The products and applications illustrated herein (including circuits external to the products and transformer construction) may be covered by one or more U.S. and foreign patents or potentially by pending U.S. and foreign patent applications assigned to Power Integrations. A complete list of Power Integrations' patents may be found at www.powerint.com.

The PI Logo, **TOPSwitch**, **TinySwitch**, **LinkSwitch**, and **EcoSmart** are registered trademarks of Power Integrations, Inc. **PI Expert** and **DPA-Switch** are trademarks of Power Integrations, Inc.

© Copyright 2003, Power Integrations, Inc.

**WORLD HEADQUARTERS
NORTH AMERICA - WEST**

Power Integrations
5245 Hellyer Avenue
San Jose, CA 95138 USA.
Main: +1-408-414-9200
Customer Service:
Phone: +1-408-414-9665
Fax: +1-408-414-9765
e-mail:
usasales@powerint.com

CHINA

Power Integrations
International Holdings, Inc.
Rm# 1705, Bao Hua Bldg.
1016 Hua Qiang Bei Lu
Shenzhen Guangdong,
518031
Phone: +86-755-8367-5143
Fax: +86-755-8377-9610
e-mail:
chinasales@powerint.com

APPLICATIONS HOTLINE

World Wide +1-408-414-9660

EUROPE & AFRICA

Power Integrations (Europe) Ltd.
Centennial Court
Easthampstead Road
Bracknell
Berkshire RG12 1YQ,
United Kingdom
Phone: +44-1344-462-300
Fax: +44-1344-311-732
e-mail: eurosales@powerint.com

KOREA

Power Integrations
International Holdings, Inc.
Rm# 402, Handuk Building,
649-4 Yeoksam-Dong,
Kangnam-Gu,
Seoul, Korea
Phone: +82-2-568-7520
Fax: +82-2-568-7474
e-mail: koreasales@powerint.com

APPLICATIONS FAX

World Wide +1-408-414-9760

SINGAPORE

Power Integrations, Singapore
51 Goldhill Plaza #16-05
Republic of Singapore,
308900
Phone: +65-6358-2160
Fax: +65-6358-2015
e-mail:
singaporesales@powerint.com

JAPAN

Power Integrations, K.K.
Keihin-Tatemono 1st Bldg.
12-20 Shin-Yokohama
2-Chome,
Kohoku-ku, Yokohama-shi,
Kanagawa 222-0033, Japan
Phone: +81-45-471-1021
Fax: +81-45-471-3717
e-mail:
japansales@powerint.com

TAIWAN

Power Integrations
International Holdings, Inc.
17F-3, No. 510
Chung Hsiao E. Rd.,
Sec. 5,
Taipei, Taiwan 110, R.O.C.
Phone: +886-2-2727-1221
Fax: +886-2-2727-1223
e-mail:
taiwansales@powerint.com

INDIA (Technical Support)

Innovatech
#1, 8th Main Road
Vasanthnagar
Bangalore, India 560052
Phone: +91-80-226-6023
Fax: +91-80-228-9727
e-mail:
indiasales@powerint.com

