

UC621XX

CMOS IC

BOOSTING VOLTAGE REGULATORS

DESCRIPTION

The UTC **UC621XX** is a positive output voltage regulator that can supply up to 1A of output current using an external transistor. Low power and high accuracy are achieved through CMOS process and metal fuses trimming technologies.

The series consists of a high precision voltage reference, an error correction circuit and a short-circuit protected output driver.

In stand-by mode, supply current can be dramatically cut. Since the input-output voltage differential is small, loss control efficiency is good.

The UTC **UC621XX** is particularly suited for use with battery operated portable products, and products where supply current regulation is required.

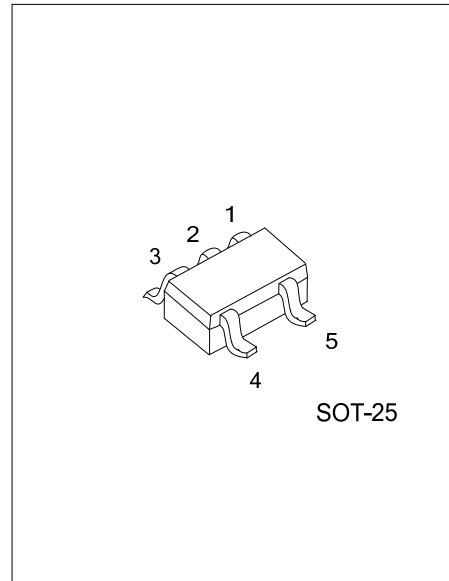

FEATURES

- * Ultra Small Input-Output Voltage Differential
: 100mA of output current is available with a differential of 0.1V.
(Performance depends on the external transistor characteristics.)
- * Maximum Output Current : 1A
- * Output Voltage Range : 2V ~ 6V in 0.1V increments
- * Highly Accurate : Set-up voltage $\pm 2\%$
- * Low Power Consumption : Typ. $50\mu\text{A}$ ($V_{\text{OUT}} = 5.0\text{V}$)
: Typ. $0.2\mu\text{A}$ (Stand-by)
- * Output Voltage Temperature Characteristics: Typ. $\pm 100\text{ppm}/^\circ\text{C}$
- * Input Stability : Typ. $0.1\%/V$

ORDERING INFORMATION

Ordering Number		Package	Packing
Lead Free	Halogen Free		
UC621XXL-AF5-R	UC621XXG-AF5-R	SOT-25	Tape Reel

Note: xx: Output Voltage, refer to Marking Information.

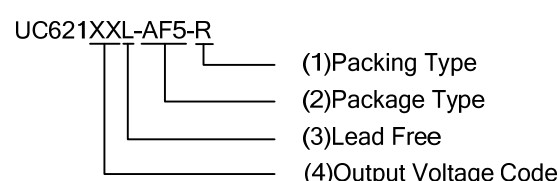
<p>UC621XXL-AF5-R</p> 	<ul style="list-style-type: none"> (1) R: Tape Reel (2) AF5: SOT-25 (3) G: Halogen Free, L: Lead Free (4) xx: refer to Marking Information
---	--

MARKING INFORMATION

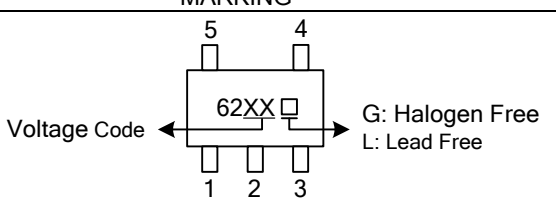
PACKAGE	VOLTAGE CODE	MARKING
SOT-25	30:3.0V 33:3.3V 40:4.0V 50:5.0V	

PIN CONFIGURATION

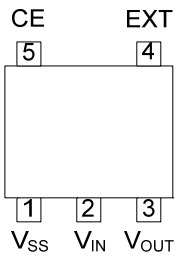

PIN NO.	PIN NAME	FUNCTION
1	V _{SS}	Ground
2	V _{IN}	Supply voltage input
3	V _{OUT}	Regulated voltage output
4	EXT	Base current control
5	CE	Chip enable

FUNCTION

SERIES	CE	OUTPUT VOLTAGE
UTC UC621XX	H	ON
	L	OFF

BLOCK DIAGRAM

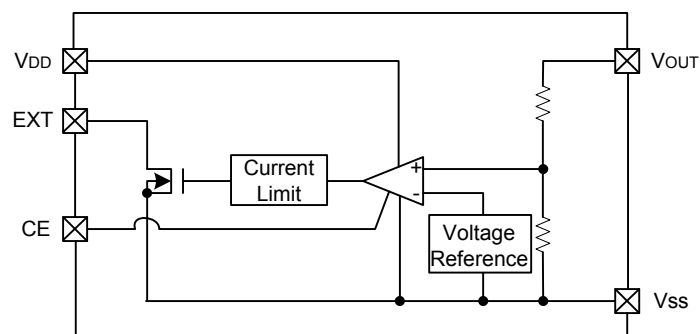

■ ABSOLUTE MAXIMUM RATINGS (T_A=25°C)

PARAMETER	SYMBOL	RATINGS	UNIT
Input Voltage	V _{IN}	12	V
Output Voltage	V _{OUT}	V _{SS} -0.3 ~ V _{IN} +0.3	V
CE Input Voltage	V _{CE}	V _{SS} -0.3 ~ V _{IN} +0.3	V
EXT Output Voltage	V _{O(EXT)}	12	V
EXT Output Current	I _{EXT}	50	mA
Power Dissipation	P _D	150	mW
Junction Temperature	T _J	+125	°C
Operating Temperature	T _{OPR}	-40 ~ +85	°C
Storage Temperature	T _{STG}	-40 ~ +150	°C

Note:1.Absolute maximum ratings are those values beyond which the device could be permanently damaged.

Absolute maximum ratings are stress ratings only and functional device operation is not implied.

2.The device is guaranteed to meet performance specification within 0°C~+70°C operating temperature range and assured by design from -20°C~+85°C.

■ ELECTRICAL CHARACTERISTICS (T_A=25°C, unless otherwise specified.)
UC62130 (V_{OUT(T)}=3.0V)

PARAMETER	SYMBOL	TEST CONDITIONS	MIN	TYP	MAX	UNIT
Output Voltage (Note2)	V _{OUT(E)}	I _{OUT} =50mA, V _{IN} =4.0V	2.940	3.000	3.060	V
Input Voltage	V _{IN}				8	V
EXT Output Voltage	V _{EXT}				8	V
CE Level Voltage	High	V _{CEH}	1.5			V
	Low	V _{CEL}			0.25	V
Load Stability (Note 4)	ΔV _{OUT}	V _{IN} =4.0V, 1mA≤I _{OUT} ≤100mA	-60		60	mV
Input-Output Voltage Differential	V _{DIFF}	I _{OUT} =100mA		100		mV
Maximum Output Current(Note 4)	I _{OUT(MAX)}	V _{IN} =4.0V		1000		mA
Supply Current1	I _{SS1}	V _{IN} =4.0V, V _{CE} =V _{SS}			0.6	μA
Supply Current2	I _{SS2}	V _{IN} =8.0V, V _{CE} =V _{IN}		50	80	μA
EXT Leakage Current	I _{LEAK}				0.5	μA
CE Level Current	High	I _{CEH}			0.1	μA
	Low	I _{CEL}	-0.2	-0.05	0	μA
Input Stability (Note 4)	$\frac{\Delta V_{OUT}}{\Delta V_{IN} \times V_{OUT}}$	I _{OUT} =50mA, 4.0V≤V _{IN} ≤8.0V		0.1	0.3	%/V
Output Voltage Temperature Characteristics (Note 4)	$\frac{\Delta V_{OUT}}{\Delta T_{OPR} \times V_{OUT}}$	I _{OUT} =10mA, -20°C≤T _{OPR} ≤85°C		±100		ppm/°C

UC62133 (V_{OUT(T)}=3.3V)

PARAMETER	SYMBOL	TEST CONDITIONS	MIN	TYP	MAX	UNIT
Output Voltage (Note2)	V _{OUT(E)}	I _{OUT} =50mA, V _{IN} =4.3V	3.234	3.300	3.366	V
Input Voltage	V _{IN}				8	V
EXT Output Voltage	V _{EXT}				8	V
CE Level Voltage	High	V _{CEH}	1.5			V
	Low	V _{CEL}			0.25	V
Load Stability (Note 4)	ΔV _{OUT}	V _{IN} =4.3V, 1mA≤I _{OUT} ≤100mA	-60		60	mV
Input-Output Voltage Differential	V _{DIFF}	I _{OUT} =100mA		100		mV
Maximum Output Current (Note 4)	I _{OUT(MAX)}	V _{IN} =4.3V		1000		mA
Supply Current1	I _{SS1}	V _{IN} =4.3V, V _{CE} =V _{SS}			0.6	μA
Supply Current2	I _{SS2}	V _{IN} =8.0V, V _{CE} =V _{IN}		50	80	μA
EXT Leakage Current	I _{LEAK}				0.5	μA
CE Level Current	High	I _{CEH}			0.1	μA
	Low	I _{CEL}	-0.2	-0.05	0	μA
Input Stability (Note 4)	$\frac{\Delta V_{OUT}}{\Delta V_{IN} \times V_{OUT}}$	I _{OUT} =50mA, 4.3V≤V _{IN} ≤8.0V		0.1	0.3	%/V
Output Voltage Temperature Characteristics (Note 4)	$\frac{\Delta V_{OUT}}{\Delta T_{OPR} \times V_{OUT}}$	I _{OUT} =10mA, -20°C≤T _{OPR} ≤85°C		±100		ppm/°C

■ ELECTRICAL CHARACTERISTICS(Cont.)
UC62140 ($V_{OUT(T)}=4.0V$)

PARAMETER	SYMBOL	TEST CONDITIONS	MIN	TYP	MAX	UNIT
Output Voltage (Note2)	$V_{OUT(E)}$	$I_{OUT} = 50mA, V_{IN} = 5.0V$	3.92	4.000	4.08	V
Input Voltage	V_{IN}				8	V
EXT Output Voltage	V_{EXT}				8	V
CE Level Voltage	High	V_{CEH}	1.5			V
	Low	V_{CEL}			0.25	V
Load Stability (Note 4)	ΔV_{OUT}	$V_{IN} = 5.0V, 1mA \leq I_{OUT} \leq 100mA$	-60		60	mV
Input-Output Voltage Differential	V_{DIFF}	$I_{OUT} = 100mA$		100		mV
Maximum Output Current(Note 4)	$I_{OUT(MAX)}$	$V_{IN} = 5.0V$		1000		mA
Supply Current1	I_{SS1}	$V_{IN} = 5.0V, V_{CE} = V_{SS}$			0.6	μA
Supply Current2	I_{SS2}	$V_{IN} = 8.0V, V_{CE} = V_{IN}$		50	80	μA
EXT Leakage Current	I_{LEAK}				0.5	μA
CE Level Current	High	I_{CEH}			0.1	μA
	Low	I_{CEL}	-0.2	-0.05	0	μA
Input Stability (Note 4)	$\frac{\Delta V_{OUT}}{\Delta V_{IN} \times V_{OUT}}$	$I_{OUT} = 50mA, 5.0V \leq V_{IN} \leq 8.0V$		0.1	0.3	%/V
Output Voltage Temperature Characteristics (Note 4)	$\frac{\Delta V_{OUT}}{\Delta T_{OPR} \times V_{OUT}}$	$I_{OUT} = 10mA, -20^{\circ}C \leq T_{OPR} \leq 85^{\circ}C$		± 100		ppm/ $^{\circ}C$

UC62150 ($V_{OUT(T)} = 5.0V$)

PARAMETER	SYMBOL	TEST CONDITIONS	MIN	TYP	MAX	UNIT
Output Voltage (Note2)	$V_{OUT(E)}$	$I_{OUT} = 50mA, V_{IN} = 6.0V$	4.900	5.000	5.100	V
Input Voltage	V_{IN}				8	V
EXT Output Voltage	V_{EXT}				8	V
CE Level Voltage	High	V_{CEH}	1.5			V
	Low	V_{CEL}			0.25	V
Load Stability (Note 4)	ΔV_{OUT}	$V_{IN} = 6.0V, 1mA \leq I_{OUT} \leq 100mA$	-60		60	mV
Input-Output Voltage Differential	V_{DIFF}	$I_{OUT} = 100mA$		100		mV
Maximum Output Current(Note 4)	$I_{OUT(MAX)}$	$V_{IN} = 6.0V$		1000		mA
Supply Current1	I_{SS1}	$V_{IN} = 6.0V, V_{CE} = V_{SS}$			0.6	μA
Supply Current2	I_{SS2}	$V_{IN} = 8.0V, V_{CE} = V_{IN}$		50	80	μA
EXT Leakage Current	I_{LEAK}				0.5	μA
CE Level Current	High	I_{CEH}			0.1	μA
	Low	I_{CEL}	-0.2	-0.05	0	μA
Input Stability (Note 4)	$\frac{\Delta V_{OUT}}{\Delta V_{IN} \times V_{OUT}}$	$I_{OUT} = 50mA, 6.0V \leq V_{IN} \leq 8.0V$		0.1	0.3	%/V
Output Voltage Temperature Characteristics (Note 4)	$\frac{\Delta V_{OUT}}{\Delta T_{OPR} \times V_{OUT}}$	$I_{OUT} = 10mA, -20^{\circ}C \leq T_{OPR} \leq 85^{\circ}C$		± 100		ppm/ $^{\circ}C$

Note: 1. $V_{OUT(T)}$ = Specified Output Voltage.

2. $V_{OUT(E)}$ = Effective Output Voltage (i.e. the output voltage when " $V_{OUT(T)}+1.0V$ " is provided at the V_{IN} pin while maintaining a certain I_{OUT} value).

3. $V_{DIFF} = \{V_{IN1} - V_{OUT1}\}$

* V_{OUT1} = A voltage equal to 98% of the Output Voltage whenever an amply stabilized I_{OUT} ($V_{OUT(T)}+1.0V$) is input.

* V_{IN1} = The Input Voltage when V_{OUT1} appears as Input Voltage is gradually decreased.

4. The characteristics for those parameters marked with an asterisk* are liable to vary depending on which transistor is used. Please use a transistor with a low saturation voltage level and h_{FE} equal to 100 or more.

■ TYPICAL APPLICATION CIRCUIT

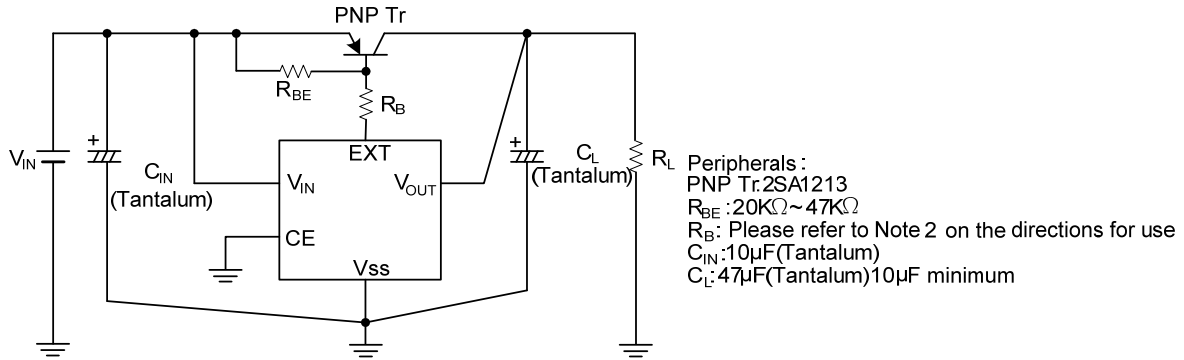

■ OPERATIONAL EXPLANATION

Functional Description

Output voltage (V_{OUT}) can be fixed by revising the external transistor's base current. This can be done by comparing the detected voltage level and the set voltage power supply level.

■ DIRECTIONS FOR USE

Suggestions for External Components

1. PNP Transistor

The selection of a transistor should take into account output current, input voltage and power dissipation for each specific application. It is recommended that a transistor that has a low output saturated voltage (V_{CE}) and high h_{FE} characteristics be used.

2. R_B Resistor

Although the IC unit is protected by a base current remitter circuit, it is recommended that a resistor (R_B) be connected between the transistor's base and the IC's EXT pin to protect the transistor.

Required output current can be calculated using the following equation although characteristic variations and conditions of use should be carefully checked before use. The following equation also indicates the conditions needed to obtain $I_{OUT(max)}$ at $V_{IN(min)}$. However, the larger the input current, the larger the output current (I_{OUT}) that can be obtained.

$$\frac{V_{IN(MIN)} - 1.2(V)}{R_B} - \frac{0.7(V)}{R_{BE}} > \frac{I_{OUT(MAX)}}{h_{FE}}$$

3. R_{BE} Resistor, C_L Capacitor

To prevent oscillation due to output load variation, use of a phase compensation capacitor C_L is recommended. Please use a Tantalum capacitor of at least 10 μ F. Please also use an R_{BE} resistor of less than 47k Ω .

An R_{BE} resistor of between 20k Ω and 47k Ω is recommended for less power consumption.

4. Input Impedance

In order to control oscillation brought about as a result of impedance at the power supply line, connect a capacitor of 10 μ F or more (Tantalum) between the external transistor's emitter and the ground pin.

Special Note

1. Protection Circuit

The built-in protect circuit is to protect the IC only. Therefore to prevent output shorts and overshoot current through the transistor, use of a resistor R_B or an overshoot current protection circuit is recommended. Care should also be taken with the transistor's power dissipation.

■ TYPICAL CHARACTERISTICS

(1) OUTPUT VOLTAGE vs. OUTPUT CURRENT

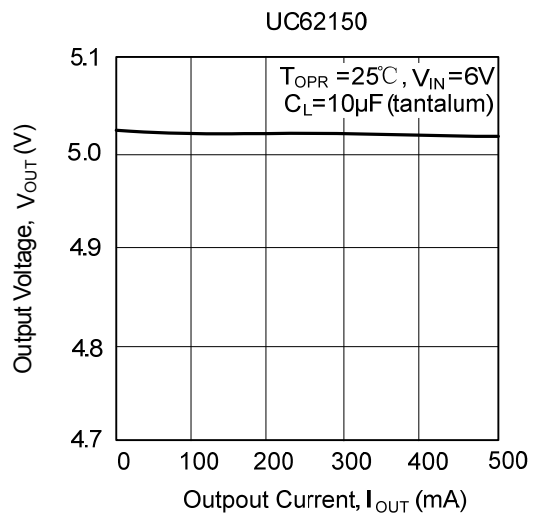
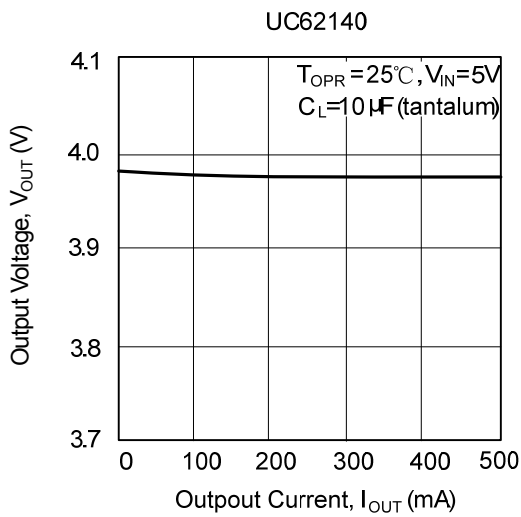
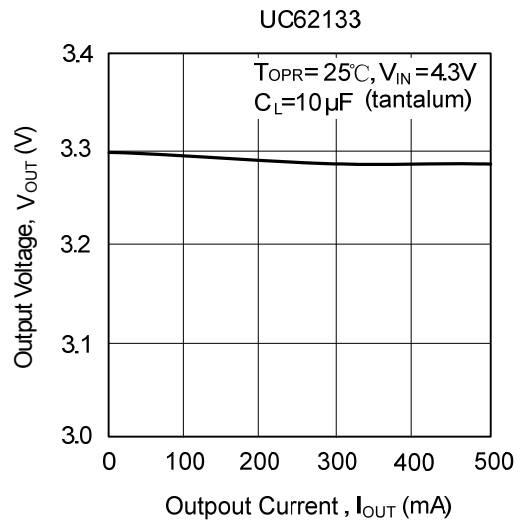
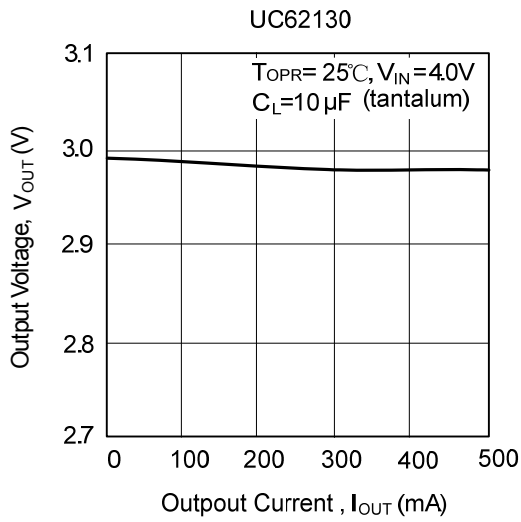

(2) OUTPUT VOLTAGE vs. INPUT VOLTAGE

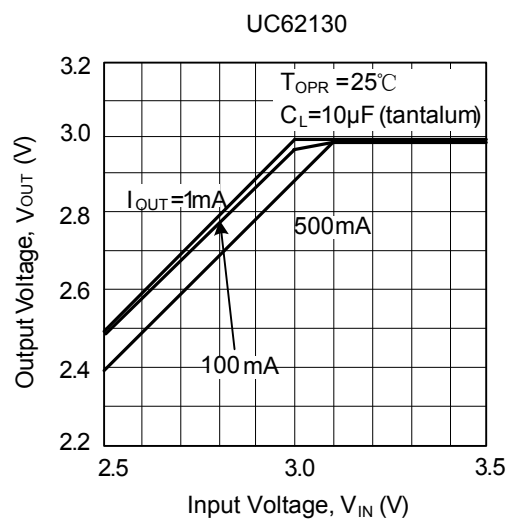
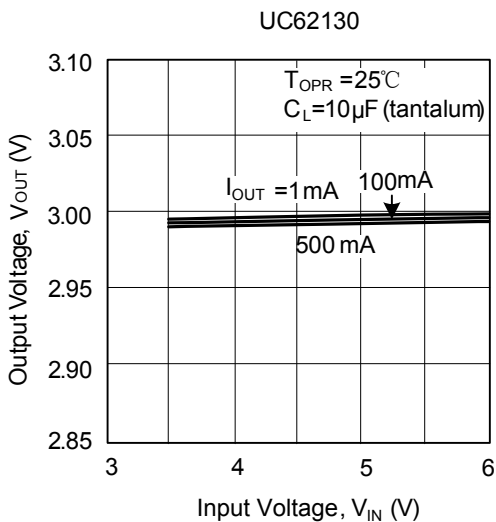

■ TYPICAL CHARACTERISTICS(Cont.)

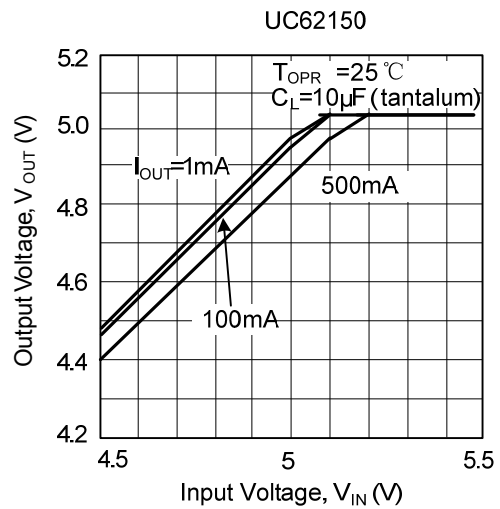
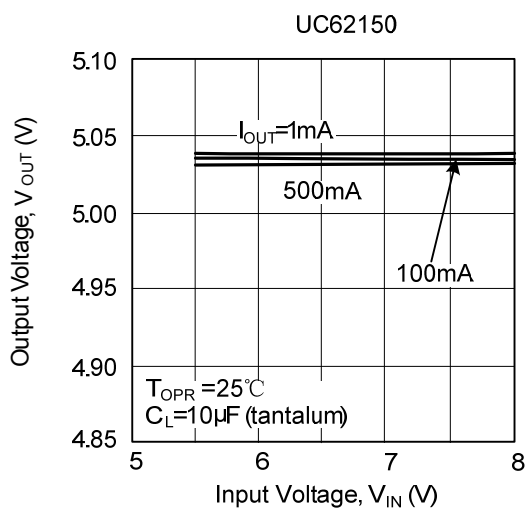
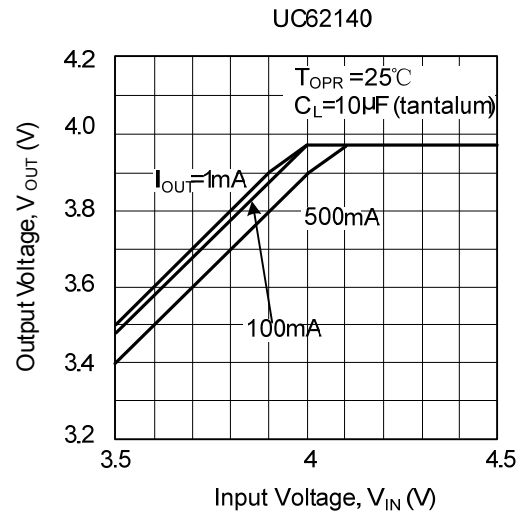
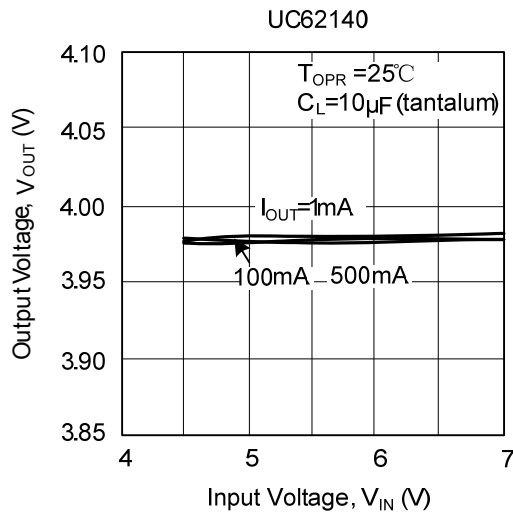
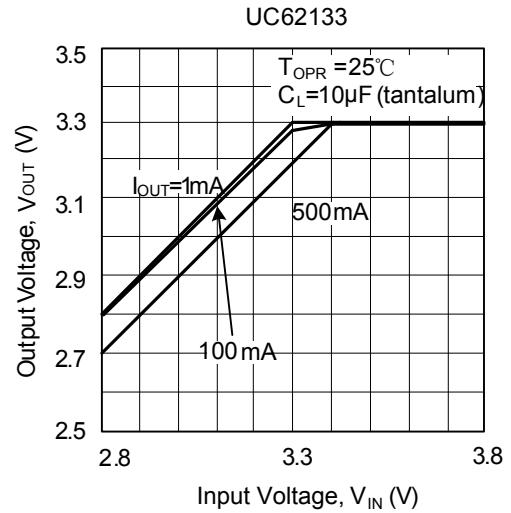
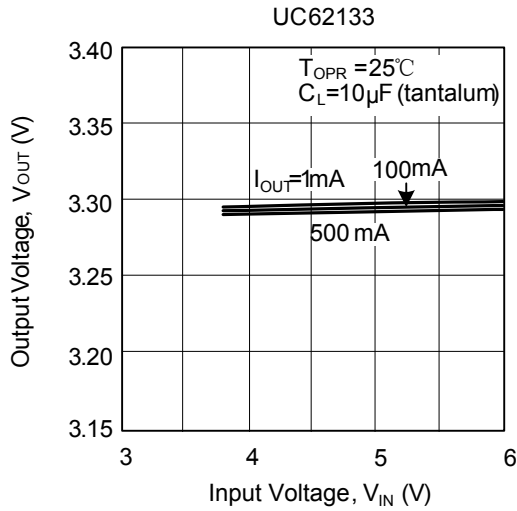

■ TYPICAL CHARACTERISTICS(Cont.)

(3) INPUT/OUTPUT VOLTAGE DIFFERENTIAL vs. OUTPUT CURRENT

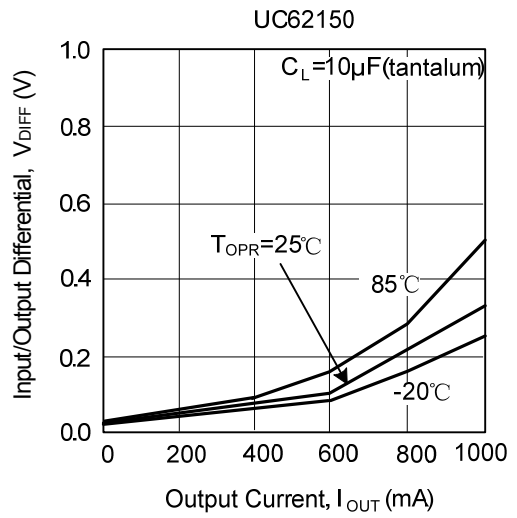
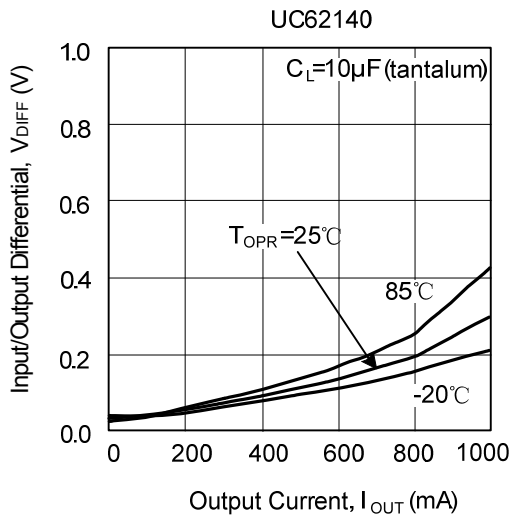
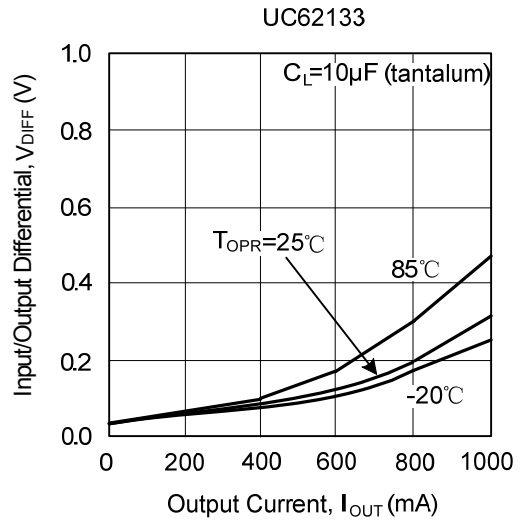
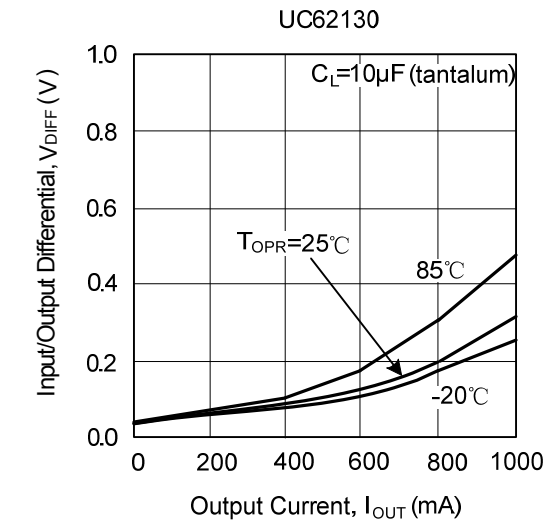

(4) SUPPLY CURRENT vs. INPUT VOLTAGE

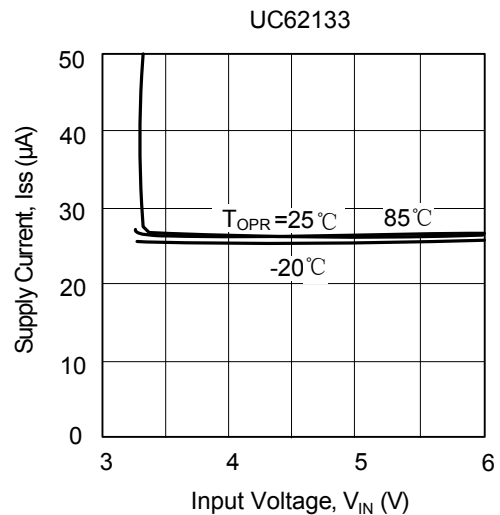
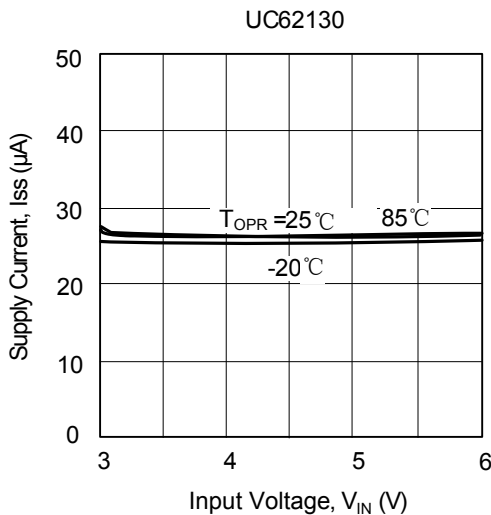

■ TYPICAL CHARACTERISTICS(Cont.)

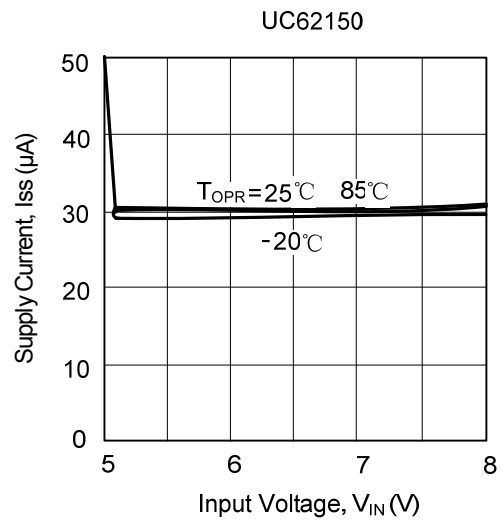
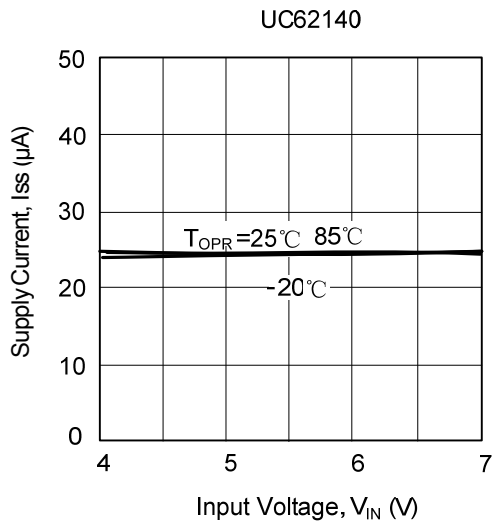

(5) OUTPUT VOLTAGE vs. AMBIENT TEMPERATURE

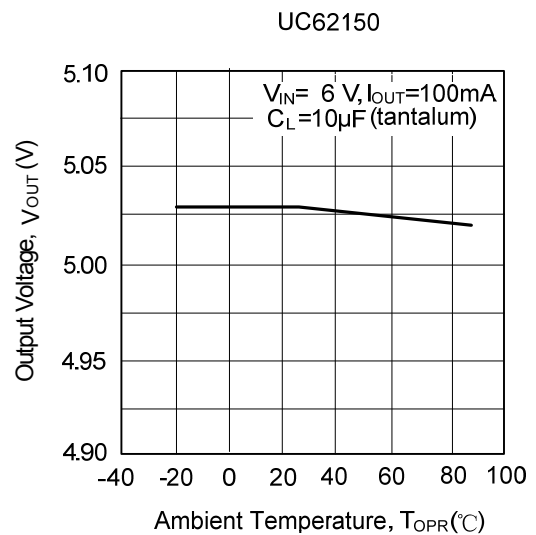
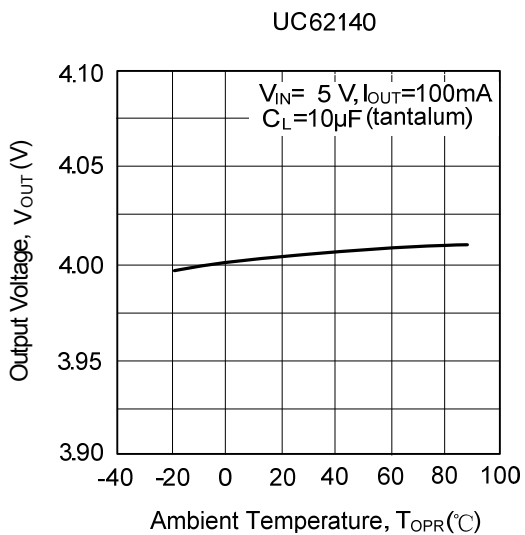
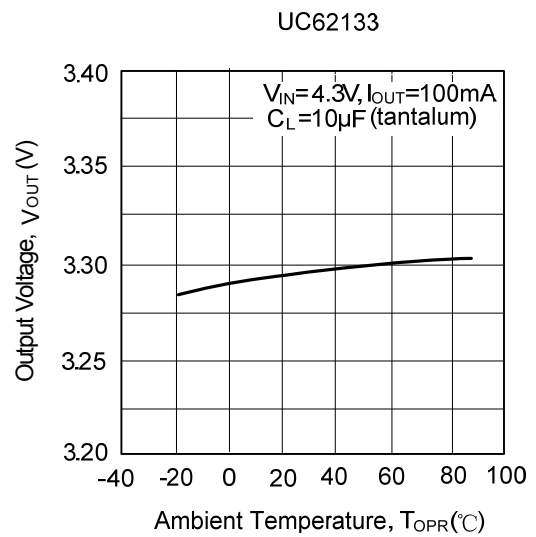
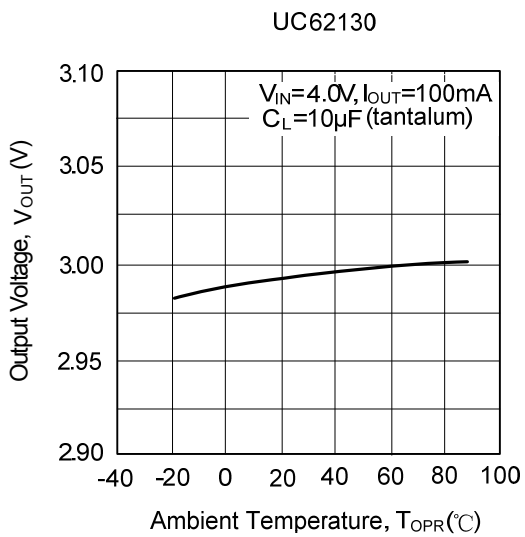

■ TYPICAL CHARACTERISTICS(Cont.)

(6) SUPPLY CURRENT vs. AMBIENT TEMPERATURE

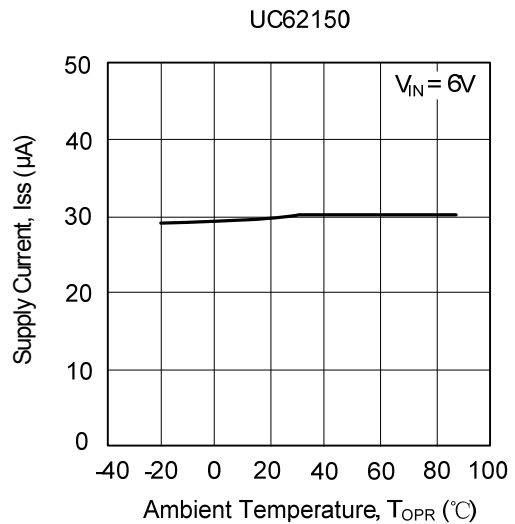
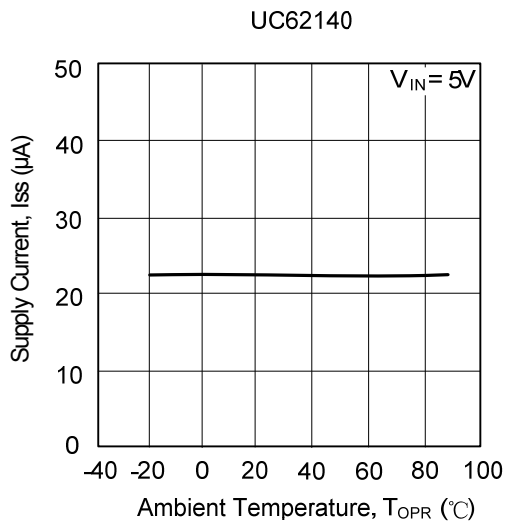
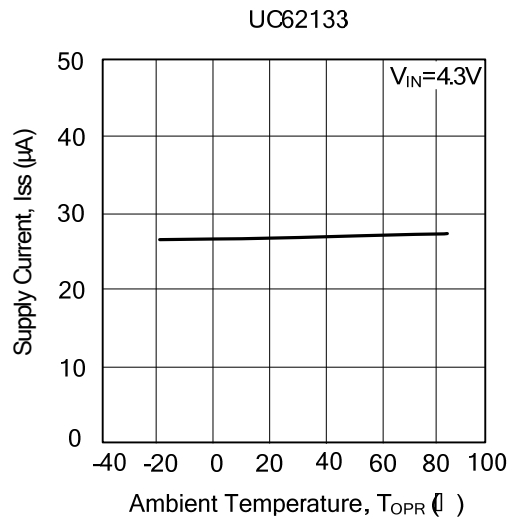
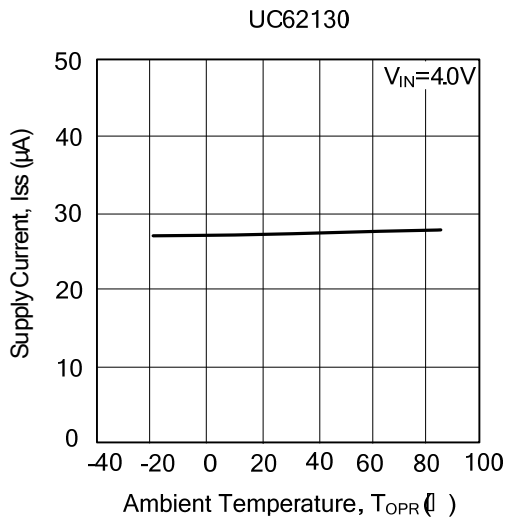

(7) INPUT TRANSIENT RESPONSE

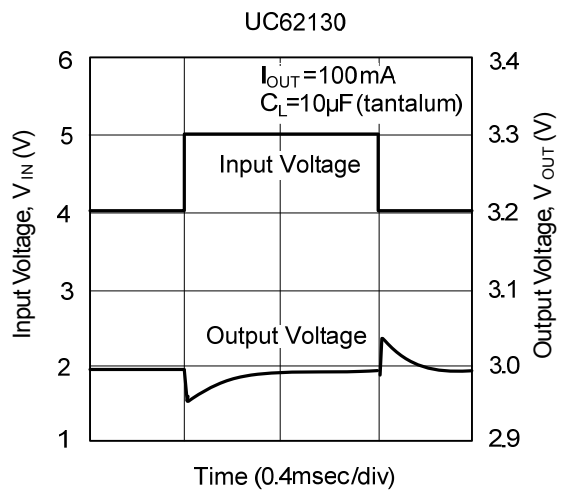
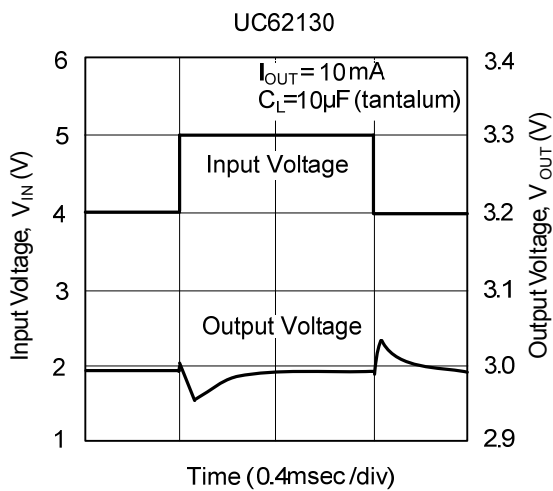

■ TYPICAL CHARACTERISTICS(Cont.)

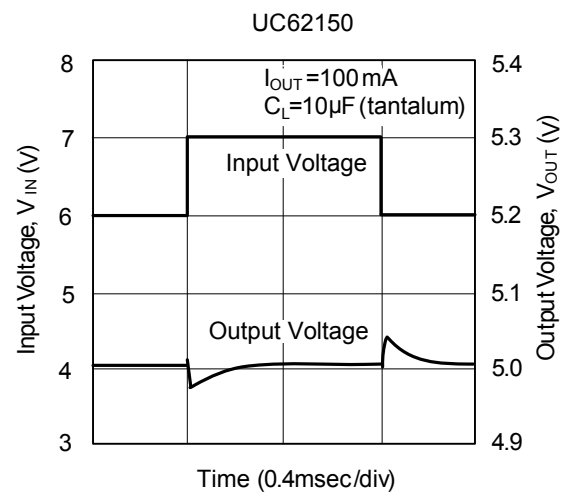
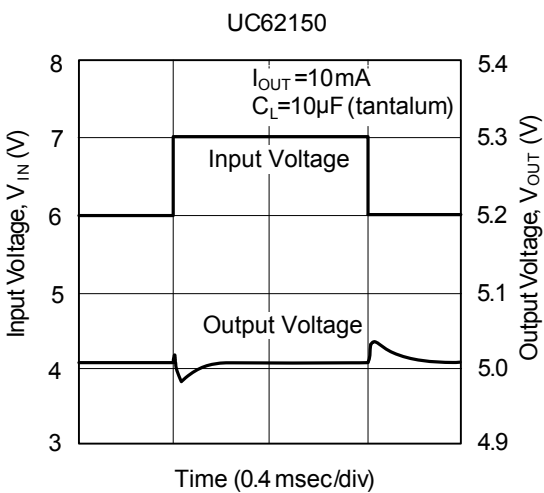
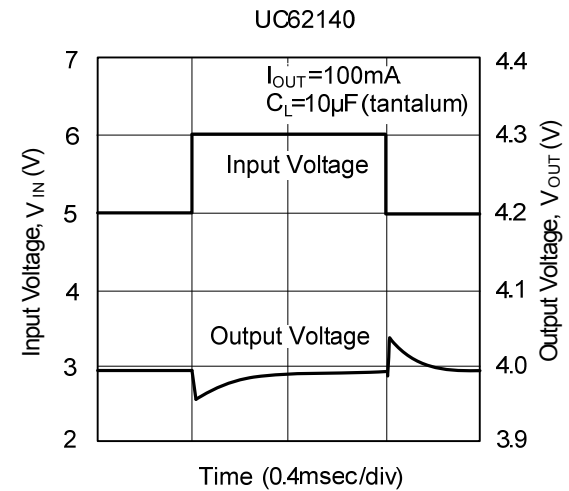
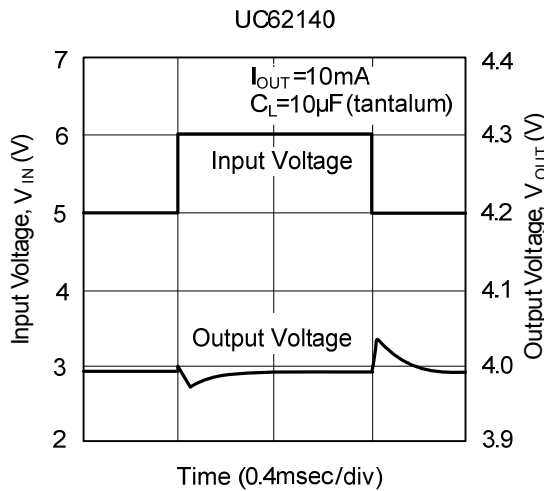
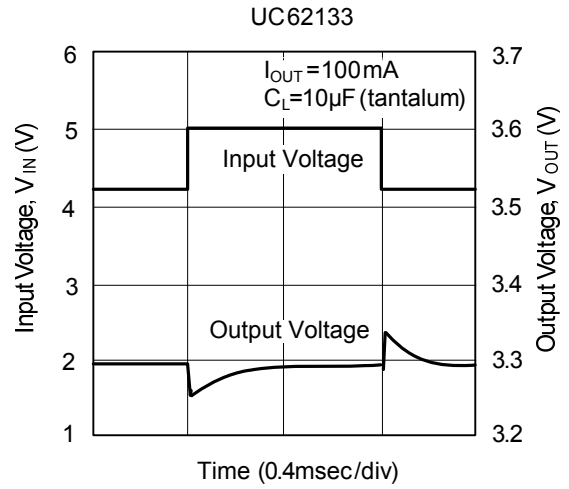
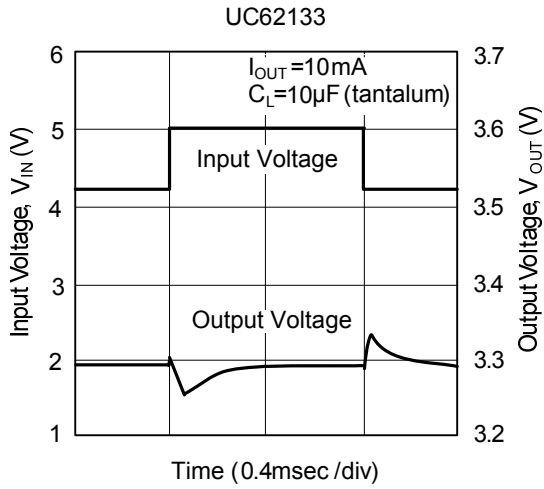

■ TYPICAL CHARACTERISTICS(Cont.)

(8) LOAD TRANSIENT RESPONSE

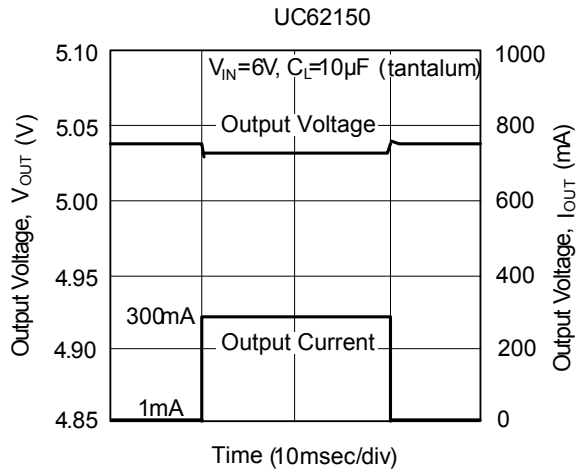
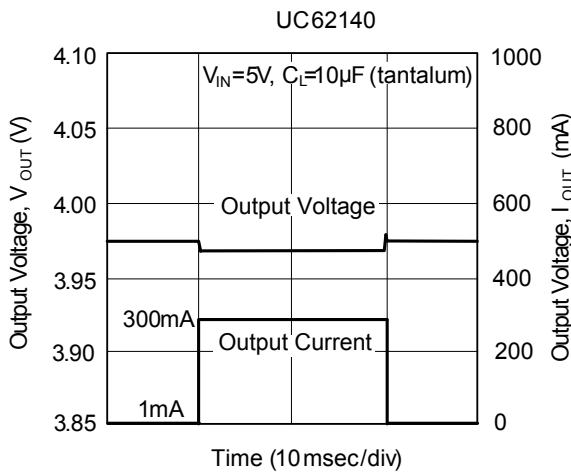
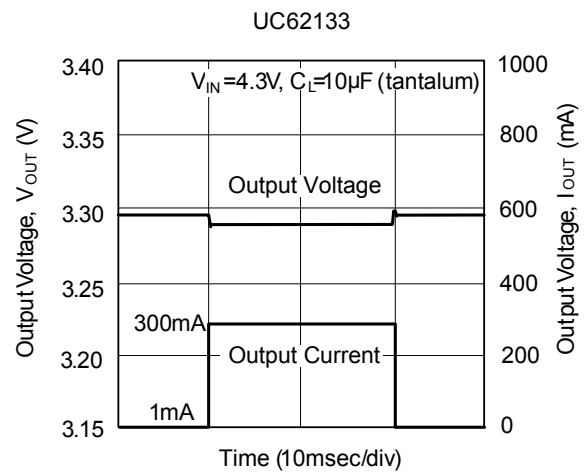
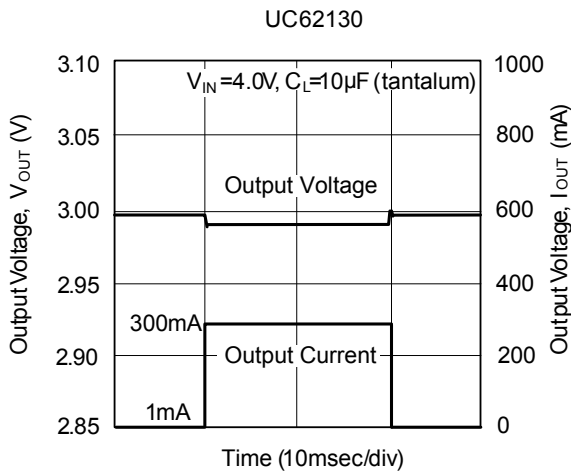

(9) RIPPLE REJECTION RATE

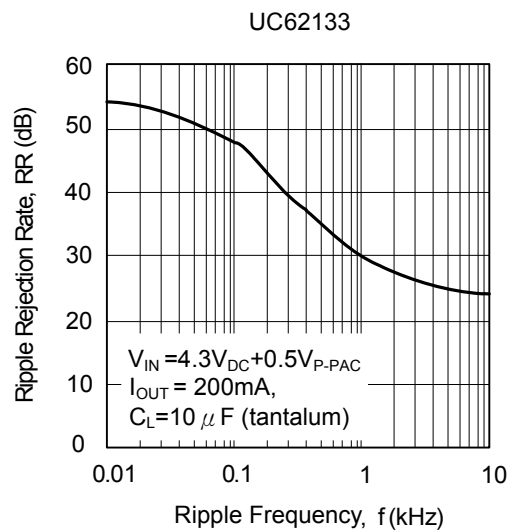
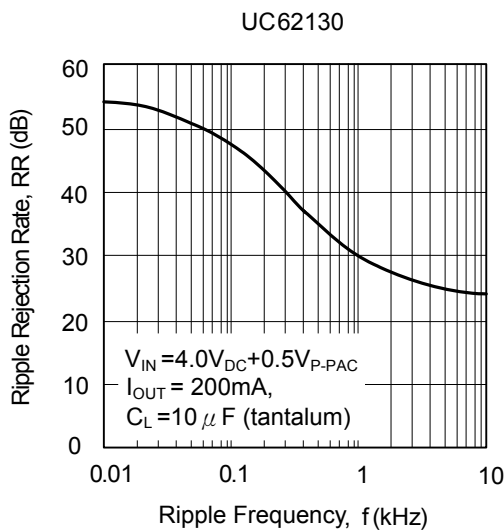

■ TYPICAL CHARACTERISTICS(Cont.)

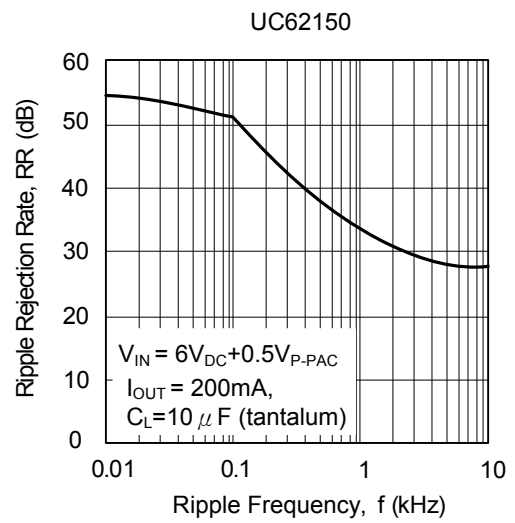
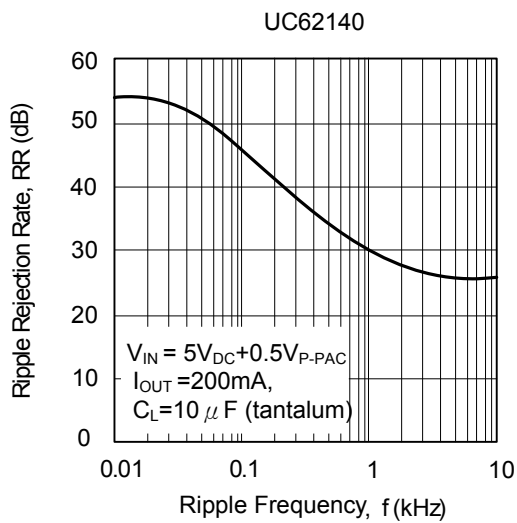

UTC assumes no responsibility for equipment failures that result from using products at values that exceed, even momentarily, rated values (such as maximum ratings, operating condition ranges, or other parameters) listed in products specifications of any and all UTC products described or contained herein. UTC products are not designed for use in life support appliances, devices or systems where malfunction of these products can be reasonably expected to result in personal injury. Reproduction in whole or in part is prohibited without the prior written consent of the copyright owner. The information presented in this document does not form part of any quotation or contract, is believed to be accurate and reliable and may be changed without notice.