

2SD1649



2039

NPN Triple Diffused Planar Silicon Transistor

T-33-11

Color TV Horizontal Deflection Output Applications(with Damper Diode)

©1755B

Applications

- High-voltage, power switching

Features

- Fast speed ($t_{max}=0.4\mu s$).
- High reliability (Adoption of HVP process).
- High breakdown voltage ($V_{CBO}=1500V$).
- Micaless package facilitating mounting operation.

Absolute Maximum Ratings at $T_a=25^\circ C$

Parameter	Symbol	Value	unit
Collector to Base Voltage	V_{CBO}	1500	V
Collector to Emitter Voltage	V_{CEO}	800	V
Emitter to Base Voltage	V_{EBO}	6	V
Collector Current	I_C	2.5	A
Peak Collector Current	i_{cp}	10	A
Collector Dissipation	P_C	50	W
Junction Temperature	T_j	150	$^\circ C$
Storage Temperature	T_{stg}	-55 to +150	$^\circ C$

$T_C=25^\circ C$

Electrical Characteristics at $T_a=25^\circ C$

Parameter	Symbol	Test Conditions	min	typ	max	unit
Collector Cutoff Current	I_{CBO}	$V_{CB}=800V, I_E=0$			10	μA
Emitter Cutoff Current	I_{EBO}	$V_{EB}=4V, I_C=0$	40		130	mA
DC Current Gain	h_{FE}	$V_{CE}=5V, I_C=0.5A$	8			
Gain Bandwidth Product	f_T	$V_{CE}=10V, I_C=0.5A$		3		MHz
Collector to Emitter Saturation Voltage	$V_{CE(sat)}$	$I_C=2A, I_B=0.6A$			8	V
Base to Emitter Saturation Voltage	$V_{BE(sat)}$	$I_C=2A, I_B=0.6A$			1.5	V
Collector to Base Breakdown Voltage	$V_{(BR)CBO}$	$I_C=5mA, I_E=0$	1500			V
Collector to Emitter Breakdown Voltage	$V_{(BR)CEO}$	$I_C=100mA, R_{BE}=\infty$	800			V
Emitter to Base Breakdown Voltage	$V_{(BR)EBO}$	$I_E=200mA, I_C=0$	7			V
Diode Forward Voltage	V_F	$I_{EC}=2.5A$			2	V
Fall Time	t_f	$I_C=2A, I_{B1}=0.6A, I_{B2}=-1.2A, V_{CC}=200V, R_L=100\Omega$			0.4	μs

Switching Time Test Circuit

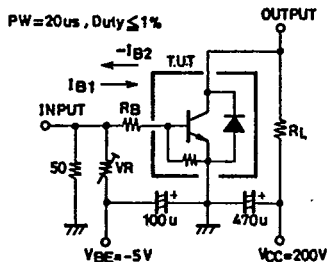

Case Outline 2039 (unit:mm)

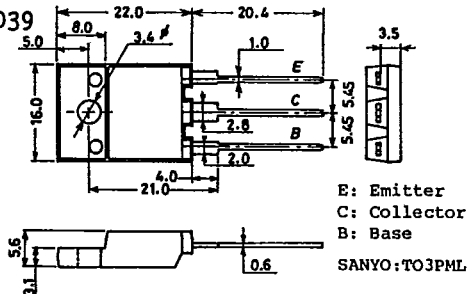

E: Emitter
C: Collector
B: Base
SANYO:TO3PML

2SD1649

T-33-11

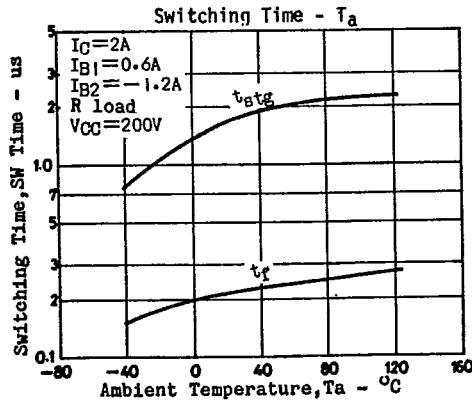
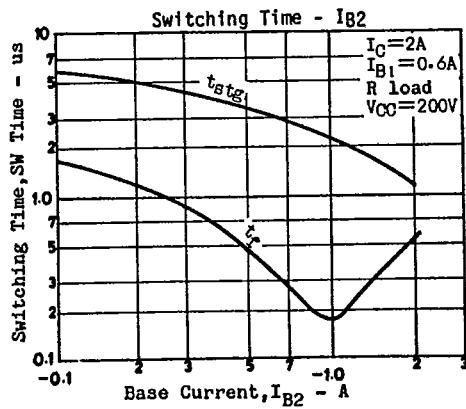
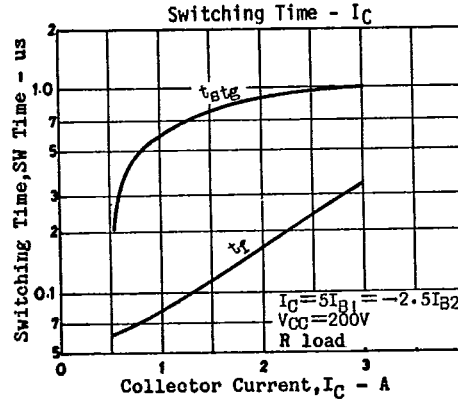
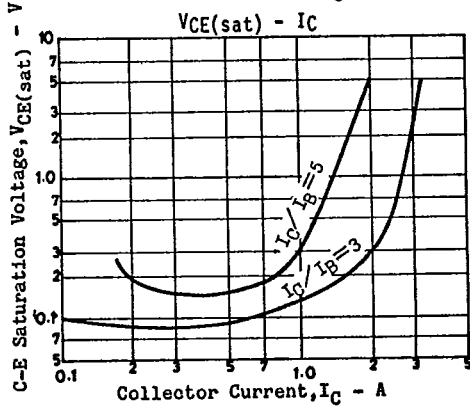
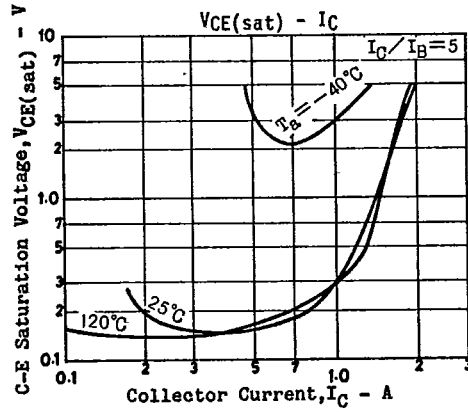
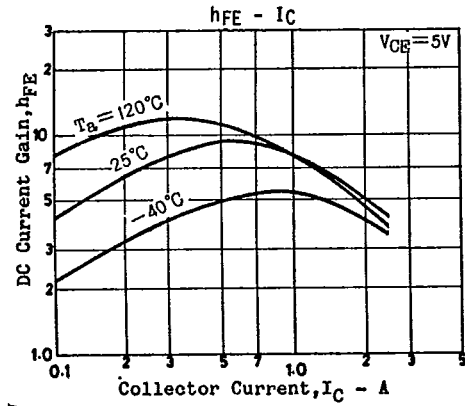
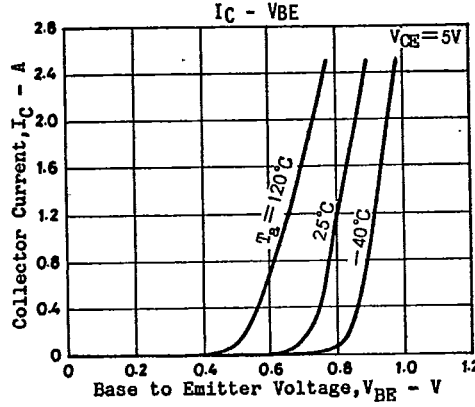
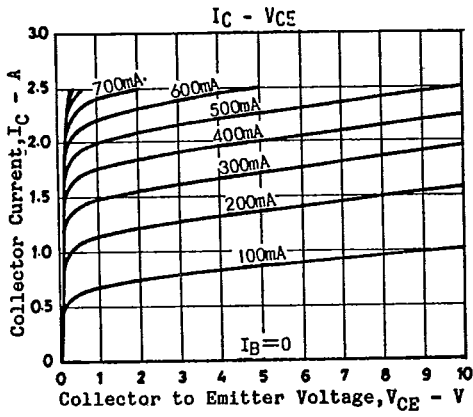

2SD1649

T-33-11

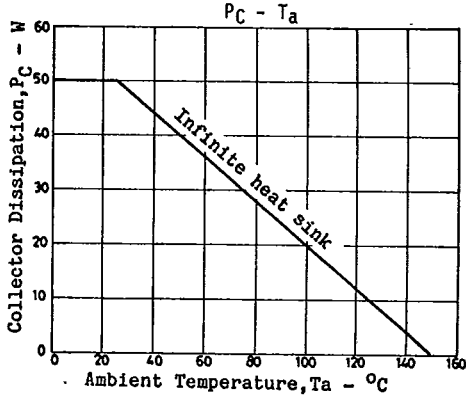
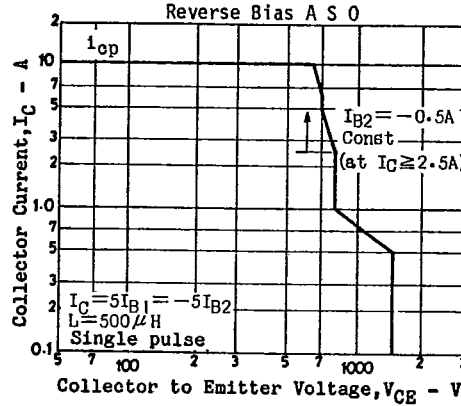
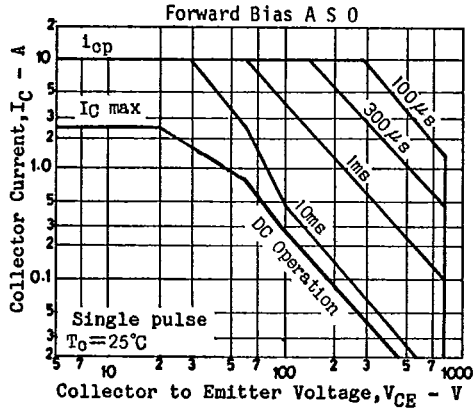

Sample Application Circuit

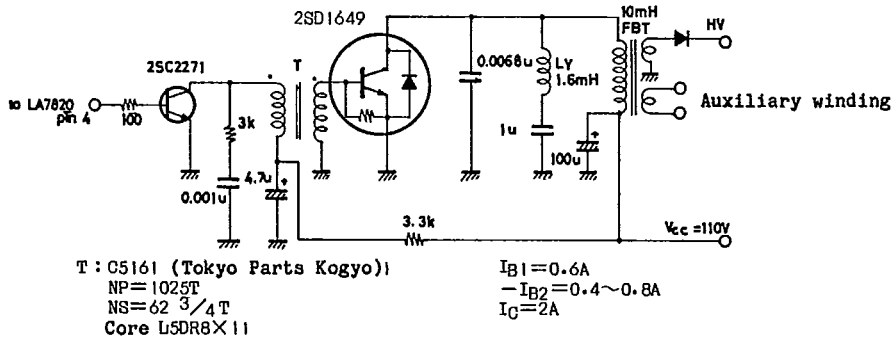

T-91-20

CASE OUTLINES AND ATTACHMENTS

- All of Sanyo Transistor case outlines are illustrated below.
- All dimensions are in mm, and dimensions which are not followed by min. or max. are represented by typical values.
- No marking is indicated.

Case Outline-[2003A]

unit:mm

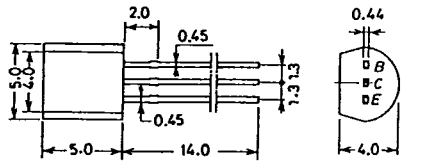

JEDEC: TO-92
EIAJ: SC-43
SANYO: NP

B. Base
C. Collector
E. Emitter

Case Outline-[2009A]

unit:mm

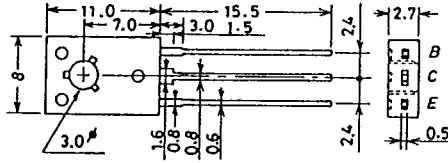

JEDEC: TO-126

B: Base
C: Collector
E: Emitter

Case Outline-[2004A]

unit:mm

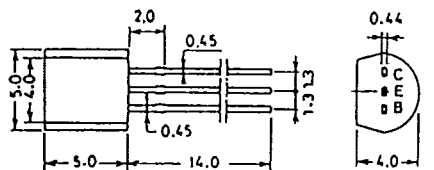

JEDEC: TO-92
EIAJ: SC-43
SANYO: NP

C. Collector
E. Emitter
B. Base

Case Outline-[2010A]

unit:mm

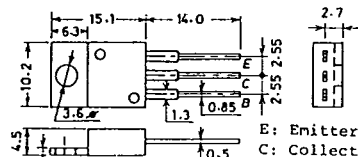

JEDEC: TO-220AB
EIAJ: SC-46

E: Emitter
C: Collector
B: Base

Case Outline-[2005A]

unit:mm

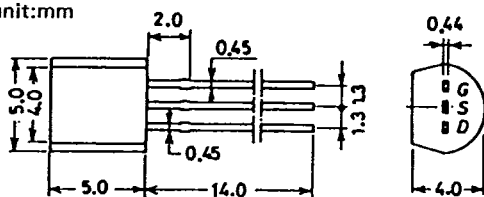

JEDEC: TO-92
EIAJ: SC-43
SANYO: NP

G: Gate
S: Source
D: Drain
B: Base
C: Collector

Case Outline-[2012]

unit:mm

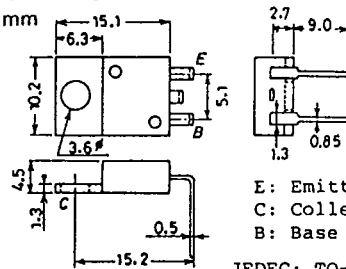

JEDEC: TO-220AA
EIAJ: SC-45

E: Emitter
C: Collector
B: Base

Case Outline-[2006A]

unit:mm

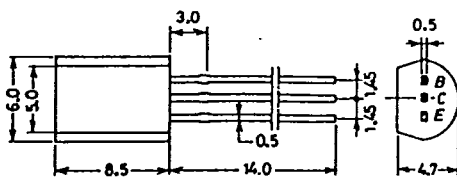

EIAJ: SC-51
SANYO: MP

B: Base
C: Collector
E: Emitter

Case Outline-[2013]

unit:mm

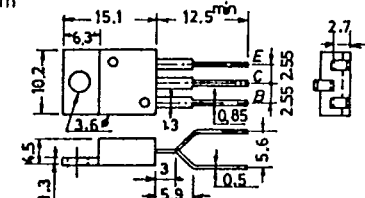

JEDEC TO-220

B: Base
C: Collector
E: Emitter

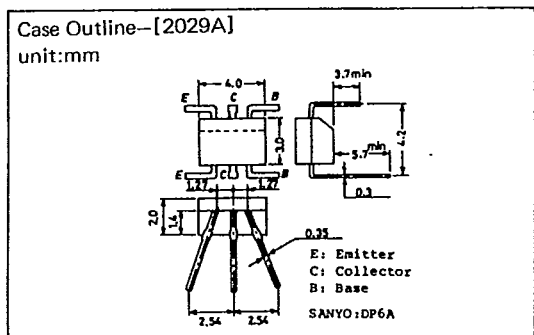
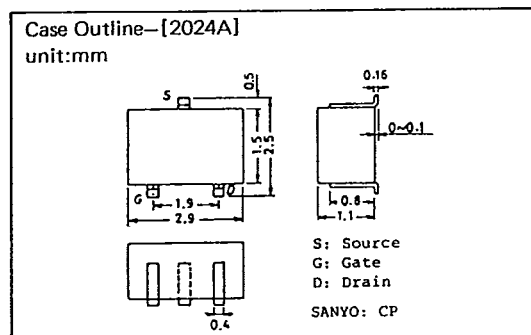
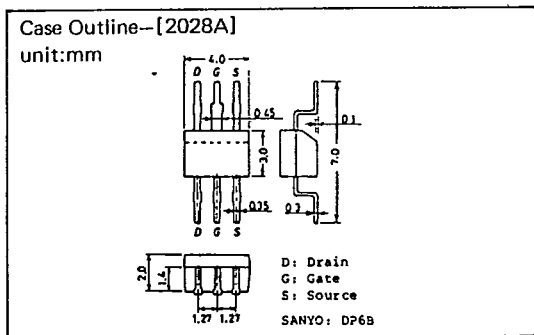
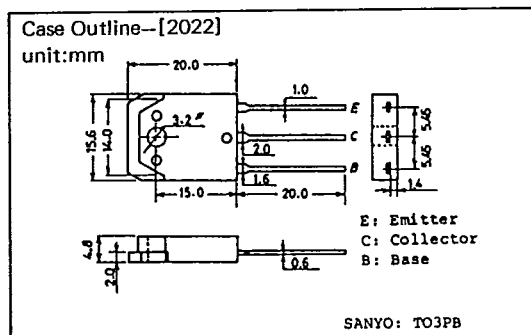
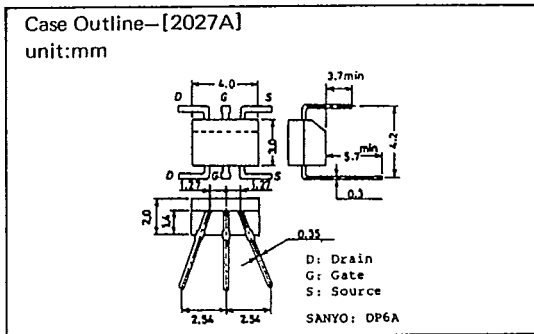
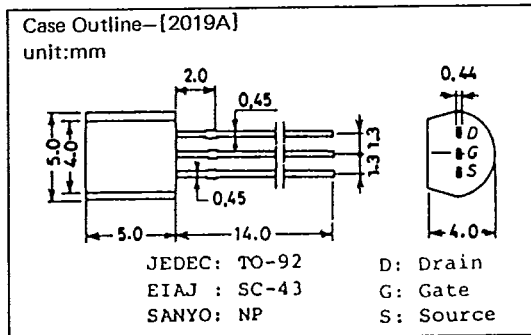
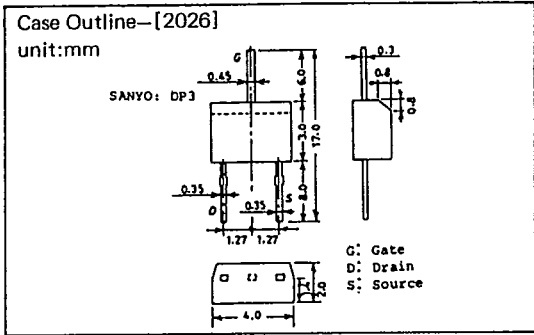
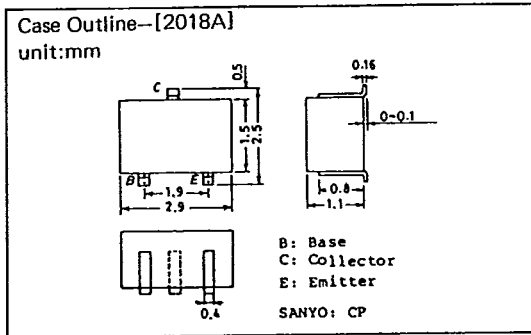
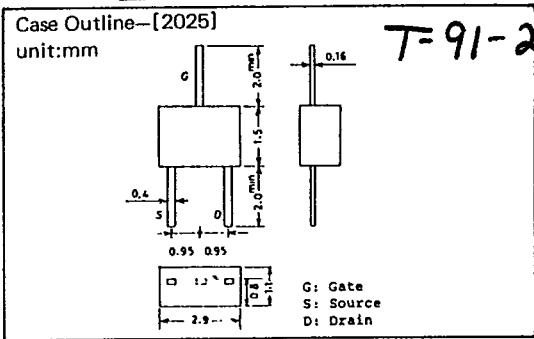
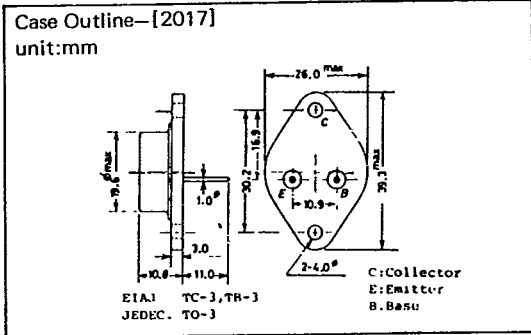

T-91-20

