

2N3904

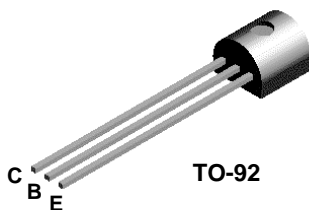

MMBT3904

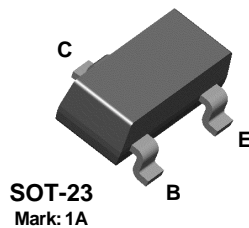

PZT3904

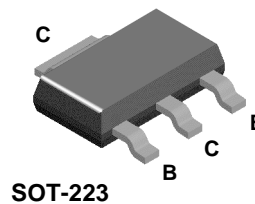

NPN General Purpose Amplifier

This device is designed as a general purpose amplifier and switch. The useful dynamic range extends to 100 mA as a switch and to 100 MHz as an amplifier.

Absolute Maximum Ratings*

$T_A = 25^\circ\text{C}$ unless otherwise noted

Symbol	Parameter	Value	Units
V_{CEO}	Collector-Emitter Voltage	40	V
V_{CBO}	Collector-Base Voltage	60	V
V_{EBO}	Emitter-Base Voltage	6.0	V
I_C	Collector Current - Continuous	200	mA
T_J, T_{stg}	Operating and Storage Junction Temperature Range	-55 to +150	$^\circ\text{C}$

* These ratings are limiting values above which the serviceability of any semiconductor device may be impaired.

NOTES:

- 1) These ratings are based on a maximum junction temperature of 150 degrees C.
- 2) These are steady state limits. The factory should be consulted on applications involving pulsed or low duty cycle operations.

Thermal Characteristics

$T_A = 25^\circ\text{C}$ unless otherwise noted

Symbol	Characteristic	Max			Units
		2N3904	*MMBT3904	**PZT3904	
P_D	Total Device Dissipation Derate above 25°C	625	350	1,000	mW
		5.0	2.8	8.0	mW/ $^\circ\text{C}$
$R_{\theta JC}$	Thermal Resistance, Junction to Case	83.3			$^\circ\text{C}/\text{W}$
$R_{\theta JA}$	Thermal Resistance, Junction to Ambient	200	357	125	$^\circ\text{C}/\text{W}$

* Device mounted on FR-4 PCB 1.6" X 1.6" X 0.06."

** Device mounted on FR-4 PCB 36 mm X 18 mm X 1.5 mm; mounting pad for the collector lead min. 6 cm².

NPN General Purpose Amplifier

(continued)

Electrical Characteristics

$T_A = 25^\circ\text{C}$ unless otherwise noted

Symbol	Parameter	Test Conditions	Min	Max	Units
OFF CHARACTERISTICS					
$V_{(BR)CEO}$	Collector-Emitter Breakdown Voltage	$I_C = 1.0\text{ mA}, I_B = 0$	40		V
$V_{(BR)CBO}$	Collector-Base Breakdown Voltage	$I_C = 10\text{ }\mu\text{A}, I_E = 0$	60		V
$V_{(BR)EBO}$	Emitter-Base Breakdown Voltage	$I_E = 10\text{ }\mu\text{A}, I_C = 0$	6.0		V
I_{BL}	Base Cutoff Current	$V_{CE} = 30\text{ V}, V_{EB} = 3\text{ V}$		50	nA
I_{CEX}	Collector Cutoff Current	$V_{CE} = 30\text{ V}, V_{EB} = 3\text{ V}$		50	nA

ON CHARACTERISTICS*

h_{FE}	DC Current Gain	$I_C = 0.1\text{ mA}, V_{CE} = 1.0\text{ V}$ $I_C = 1.0\text{ mA}, V_{CE} = 1.0\text{ V}$ $I_C = 10\text{ mA}, V_{CE} = 1.0\text{ V}$ $I_C = 50\text{ mA}, V_{CE} = 1.0\text{ V}$ $I_C = 100\text{ mA}, V_{CE} = 1.0\text{ V}$	40 70 100 60 30	300	
$V_{CE(sat)}$	Collector-Emitter Saturation Voltage	$I_C = 10\text{ mA}, I_B = 1.0\text{ mA}$ $I_C = 50\text{ mA}, I_B = 5.0\text{ mA}$		0.2 0.3	V V
$V_{BE(sat)}$	Base-Emitter Saturation Voltage	$I_C = 10\text{ mA}, I_B = 1.0\text{ mA}$ $I_C = 50\text{ mA}, I_B = 5.0\text{ mA}$	0.65	0.85 0.95	V V

SMALL SIGNAL CHARACTERISTICS

f_T	Current Gain - Bandwidth Product	$I_C = 10\text{ mA}, V_{CE} = 20\text{ V}, f = 100\text{ MHz}$	300		MHz
C_{obo}	Output Capacitance	$V_{CB} = 5.0\text{ V}, I_E = 0, f = 1.0\text{ MHz}$		4.0	pF
C_{ibo}	Input Capacitance	$V_{EB} = 0.5\text{ V}, I_C = 0, f = 1.0\text{ MHz}$		8.0	pF
NF	Noise Figure	$I_C = 100\text{ }\mu\text{A}, V_{CE} = 5.0\text{ V}, R_S = 1.0\text{ k}\Omega, f = 10\text{ Hz to }15.7\text{ kHz}$		5.0	dB

SWITCHING CHARACTERISTICS

t_d	Delay Time	$V_{CC} = 3.0\text{ V}, V_{BE} = 0.5\text{ V},$		35	ns
t_r	Rise Time	$I_C = 10\text{ mA}, I_{B1} = 1.0\text{ mA}$		35	ns
t_s	Storage Time	$V_{CC} = 3.0\text{ V}, I_C = 10\text{ mA}$		200	ns
t_f	Fall Time	$I_{B1} = I_{B2} = 1.0\text{ mA}$		50	ns

*Pulse Test: Pulse Width $\leq 300\text{ }\mu\text{s}$, Duty Cycle $\leq 2.0\%$

Spice Model

NPN (Is=6.734f Xti=3 Eg=1.11 Vaf=74.03 Bf=416.4 Ne=1.259 Ise=6.734 Ikf=66.78m Xtb=1.5 Br=.7371 Nc=2 Isc=0 Ikr=0 Rc=1 Cjc=3.638p Mjc=.3085 Vjc=.75 Fc=.5 Cje=4.493p Mje=.2593 Vje=.75 Tr=239.5n Tf=301.2p Itf=.4 Vtf=4 Xtf=2 Rb=10)

2N3904 / MMBT3904 / PZT3904

Typical Characteristics

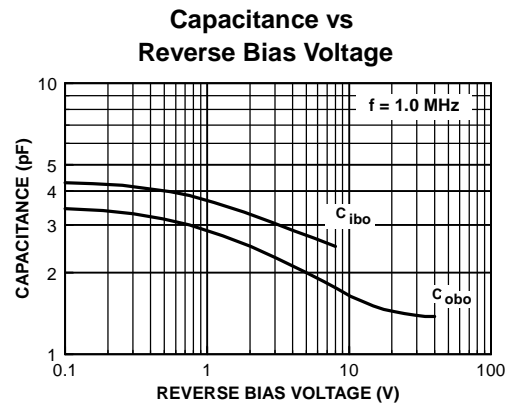
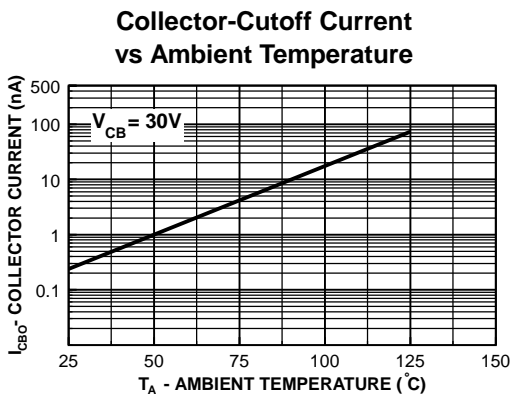
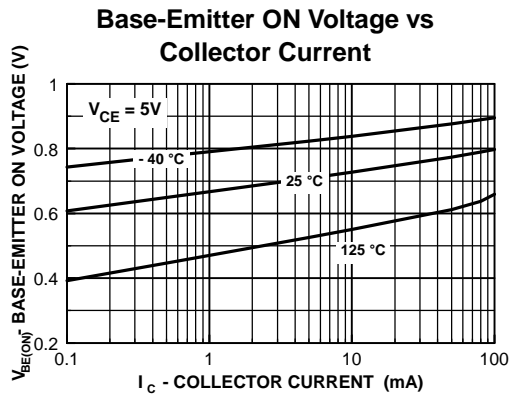
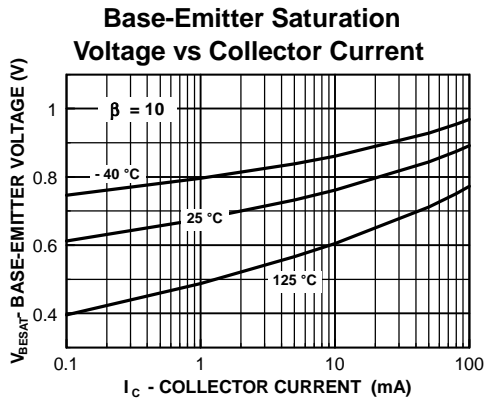
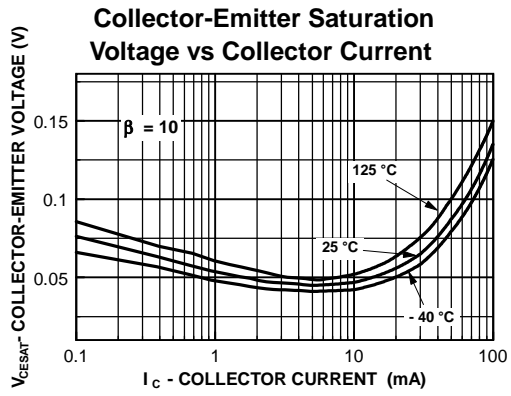
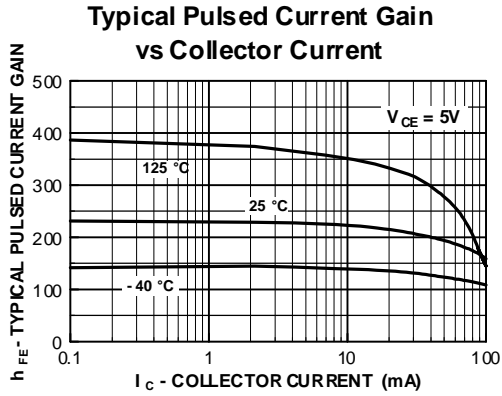

NPN General Purpose Amplifier

(continued)

2N3904 / MMBT3904 / PZT3904

Typical Characteristics (continued)

Noise Figure vs Frequency

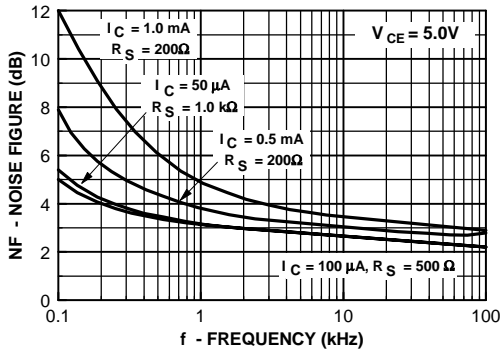

Noise Figure vs Source Resistance

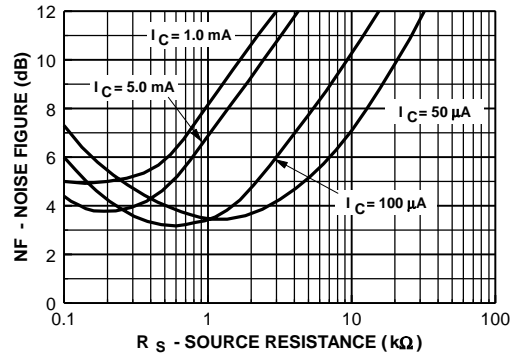

Current Gain and Phase Angle vs Frequency

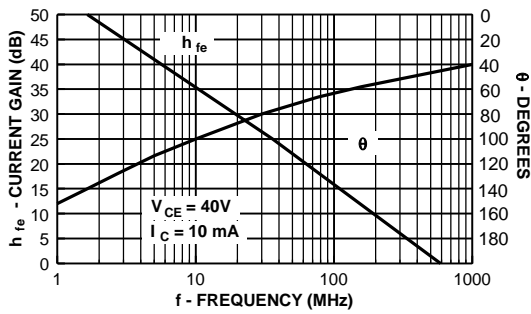

Power Dissipation vs Ambient Temperature

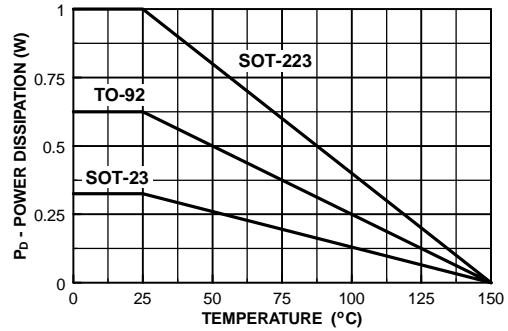

Turn-On Time vs Collector Current

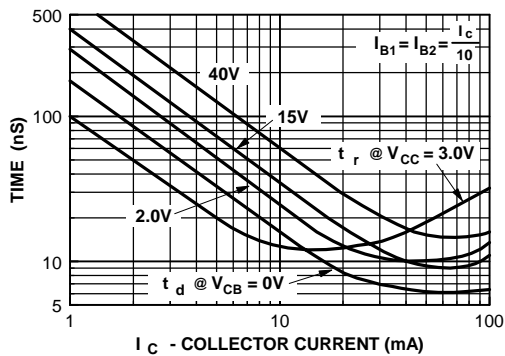

Rise Time vs Collector Current

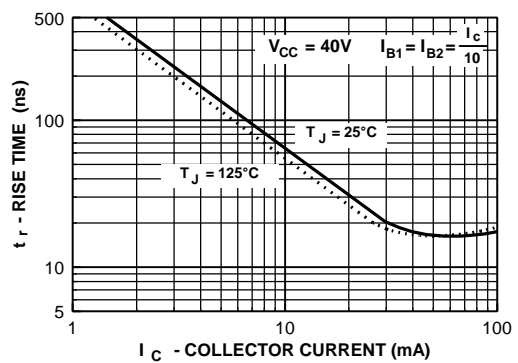

NPN General Purpose Amplifier

(continued)

2N3904 / MMBT3904 / PZT3904

Typical Characteristics (continued)

Storage Time vs Collector Current

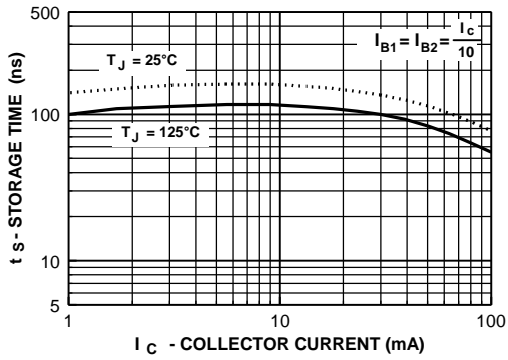

Fall Time vs Collector Current

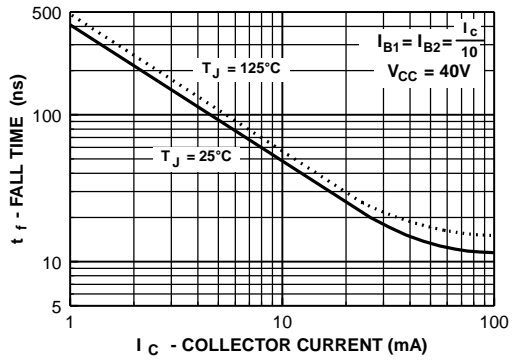

Current Gain

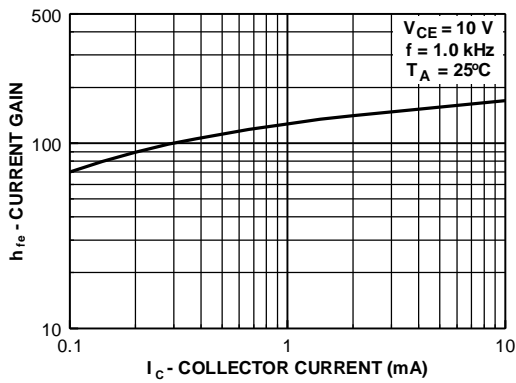

Output Admittance

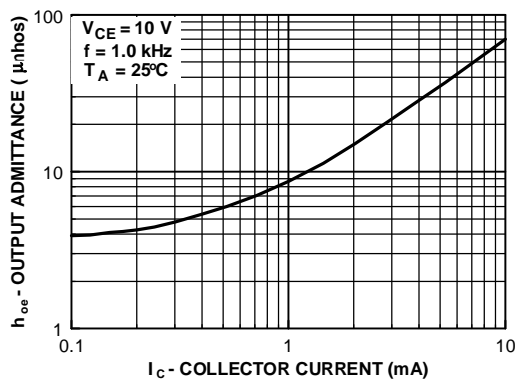

Input Impedance

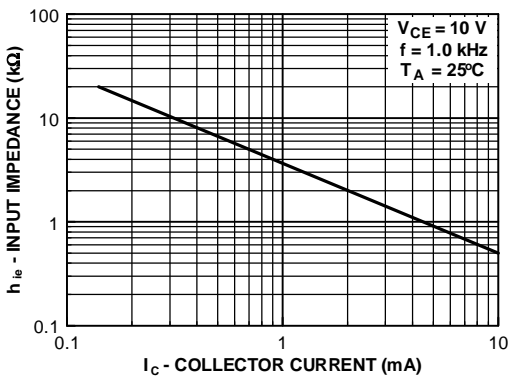

Voltage Feedback Ratio

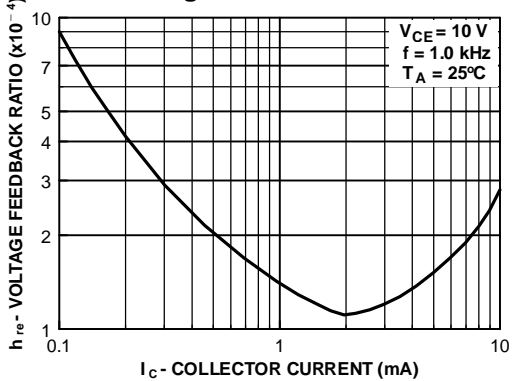

Test Circuits

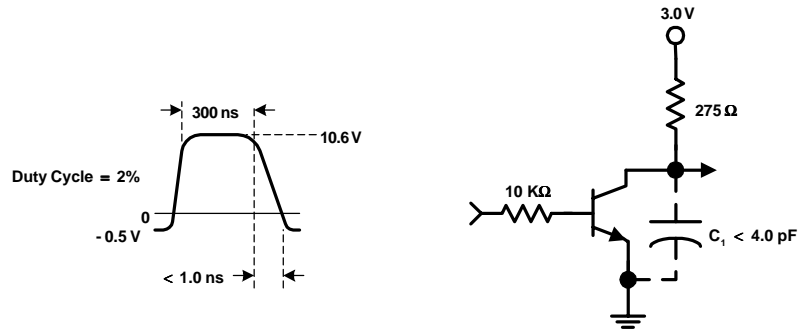

FIGURE 1: Delay and Rise Time Equivalent Test Circuit

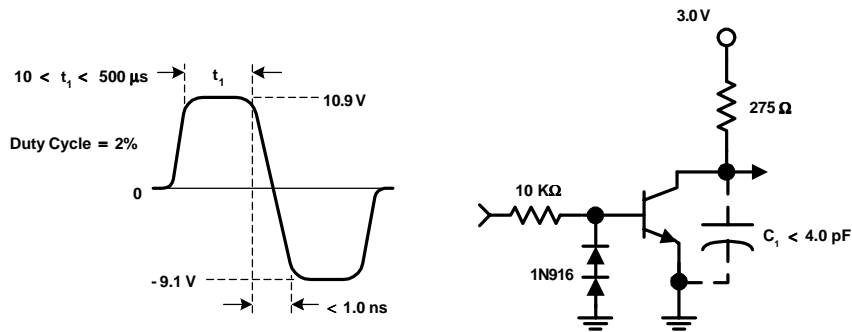

FIGURE 2: Storage and Fall Time Equivalent Test Circuit

TO-92 Tape and Reel Data



TO-92 Packaging Configuration: Figure 1.0

FSCINT Label sample



F63TNR Label sample

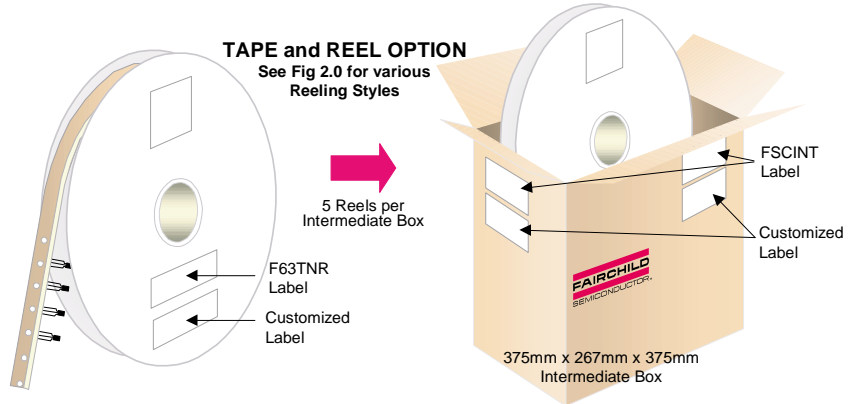

TO-92 TNR/AMMO PACKING INFORMATION

Packing	Style	Quantity	EOL code
Reel	A	2,000	D26Z
	E	2,000	D27Z
Ammo	M	2,000	D74Z
	P	2,000	D75Z

Unit weight = 0.22 gm
 Reel weight with components = 1.04 kg
 Ammo weight with components = 1.02 kg
 Max quantity per intermediate box = 10,000 units

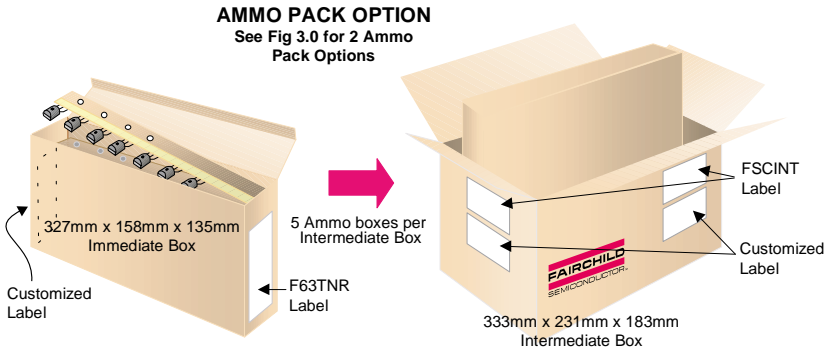

(TO-92) BULK PACKING INFORMATION

EOL CODE	DESCRIPTION	LEADCLIP DIMENSION	QUANTITY
J18Z	TO-18 OPTION STD	NO LEAD CLIP	2.0 K / BOX
J05Z	TO-5 OPTION STD	NO LEAD CLIP	1.5 K / BOX
NO EOL CODE	TO-92 STANDARD STRAIGHT FOR: PKG 92, 94 (NON PROELECTRON SERIES), 96	NO LEADCLIP	2.0 K / BOX
L34Z	TO-92 STANDARD STRAIGHT FOR: PKG 94 (PROELECTRON SERIES BCXXX, BFXXX, BSRXXX), 97, 98	NO LEADCLIP	2.0 K / BOX

BULK OPTION

See Bulk Packing Information table

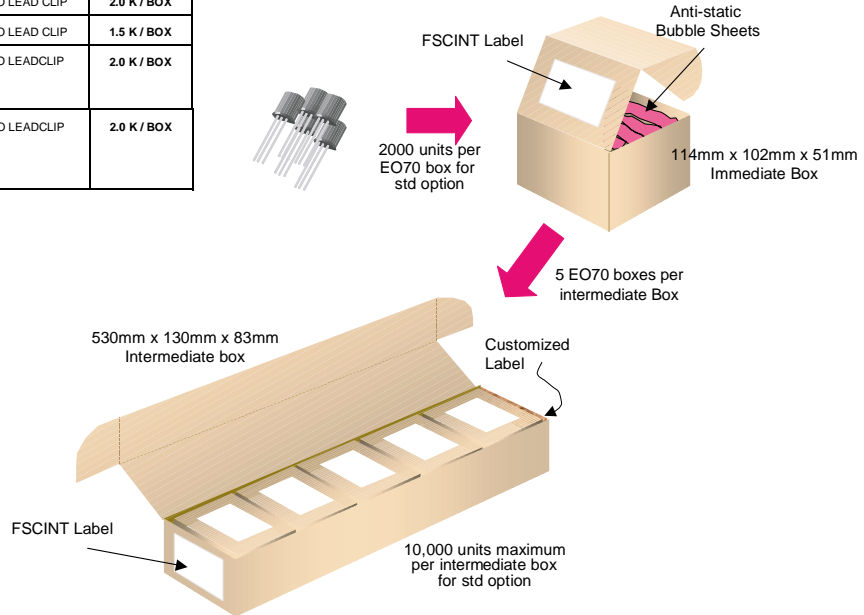

TO-92 Tape and Reel Data, continued

TO-92 Reeling Style

Configuration: Figure 2.0

Machine Option "A" (H)

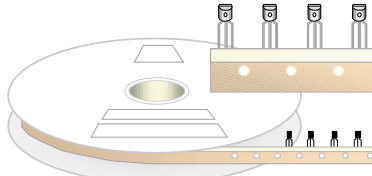

Style "A", D26Z, D70Z (s/h)

Machine Option "E" (J)

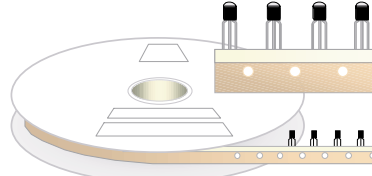

Style "E", D27Z, D71Z (s/h)

TO-92 Radial Ammo Packaging

Configuration: Figure 3.0

FIRST WIRE OFF IS COLLECTOR
ADHESIVE TAPE IS ON THE TOP SIDE
FLAT OF TRANSISTOR IS ON TOP

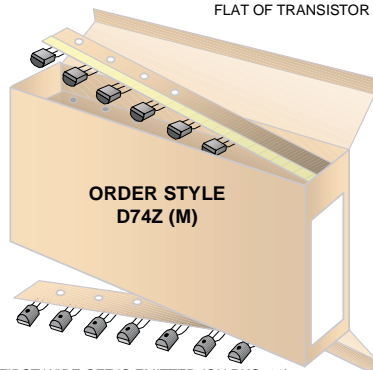

ORDER STYLE
D74Z (M)

FIRST WIRE OFF IS EMITTER (ON PKG. 92)
ADHESIVE TAPE IS ON BOTTOM SIDE
FLAT OF TRANSISTOR IS ON BOTTOM

FIRST WIRE OFF IS EMITTER
ADHESIVE TAPE IS ON THE TOP SIDE
FLAT OF TRANSISTOR IS ON BOTTOM

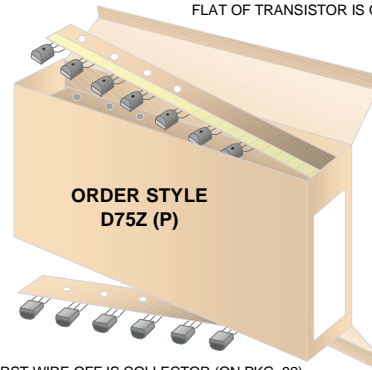

ORDER STYLE
D75Z (P)

FIRST WIRE OFF IS COLLECTOR (ON PKG. 92)
ADHESIVE TAPE IS ON BOTTOM SIDE
FLAT OF TRANSISTOR IS ON TOP

TO-92 Tape and Reel Data, continued

**TO-92 Tape and Reel Taping
Dimension Configuration: Figure 4.0**

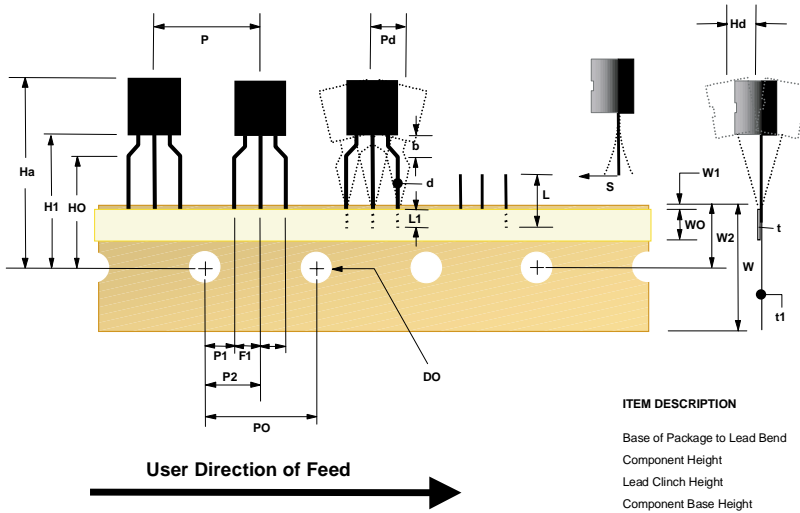

ITEM DESCRIPTION	SYMBOL	DIMENSION
Base of Package to Lead Bend	b	0.098 (max)
Component Height	Ha	0.928 (+/- 0.025)
Lead Clinch Height	HO	0.630 (+/- 0.020)
Component Base Height	H1	0.748 (+/- 0.020)
Component Alignment (side/side)	Pd	0.040 (max)
Component Alignment (front/back)	Hd	0.031 (max)
Component Pitch	P	0.500 (+/- 0.020)
Feed Hole Pitch	PO	0.500 (+/- 0.008)
Hole Center to First Lead	P1	0.150 (+0.009, -0.010)
Hole Center to Component Center	P2	0.247 (+/- 0.007)
Lead Spread	F1/F2	0.104 (+/- 0.010)
Lead Thickness	d	0.018 (+0.002, -0.003)
Cut Lead Length	L	0.429 (max)
Taped Lead Length	L1	0.209 (+0.051, -0.052)
Taped Lead Thickness	t	0.032 (+/- 0.006)
Carrier Tape Thickness	t1	0.021 (+/- 0.006)
Carrier Tape Width	W	0.708 (+0.020, -0.019)
Hold - down Tape Width	WO	0.236 (+/- 0.012)
Hold - down Tape position	W1	0.035 (max)
Feed Hole Position	W2	0.360 (+/- 0.025)
Sprocket Hole Diameter	DO	0.157 (+0.008, -0.007)
Lead Spring Out	S	0.004 (max)

Note : All dimensions are in inches.

**TO-92 Reel
Configuration: Figure 5.0**

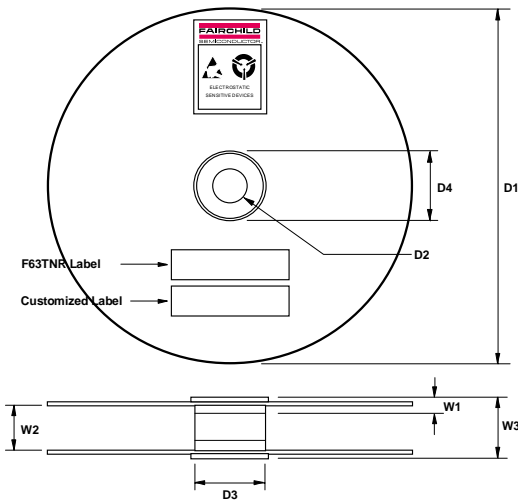

ITEM DESCRIPTION	SYMBOL	MINIMUM	MAXIMUM
Reel Diameter	D1	13.975	14.025
Arbor Hole Diameter (Standard)	D2	1.160	1.200
(Small Hole)	D2	0.650	0.700
Core Diameter	D3	3.100	3.300
Hub Recess Inner Diameter	D4	2.700	3.100
Hub Recess Depth	W1	0.370	0.570
Flange to Flange Inner Width	W2	1.630	1.690
Hub to Hub Center Width	W3		2.090

Note: All dimensions are in inches

TO-92 Package Dimensions



TO-92 (FS PKG Code 92, 94, 96)

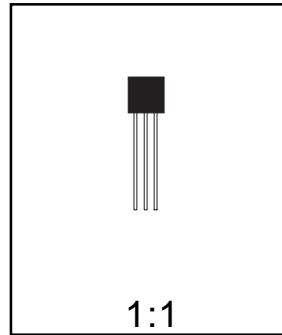
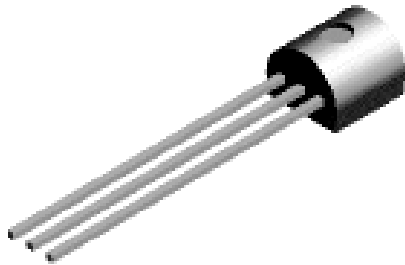

Scale 1:1 on letter size paper

Dimensions shown below are in:
inches [millimeters]

Part Weight per unit (gram): 0.1977

TO-92 (92,94,96)

PIN	92		94		96	
	B	F	B	F	B	F
1	E	D	E	D	B	S
2	B	S	C	G	E	D
3	C	G	B	S	C	G

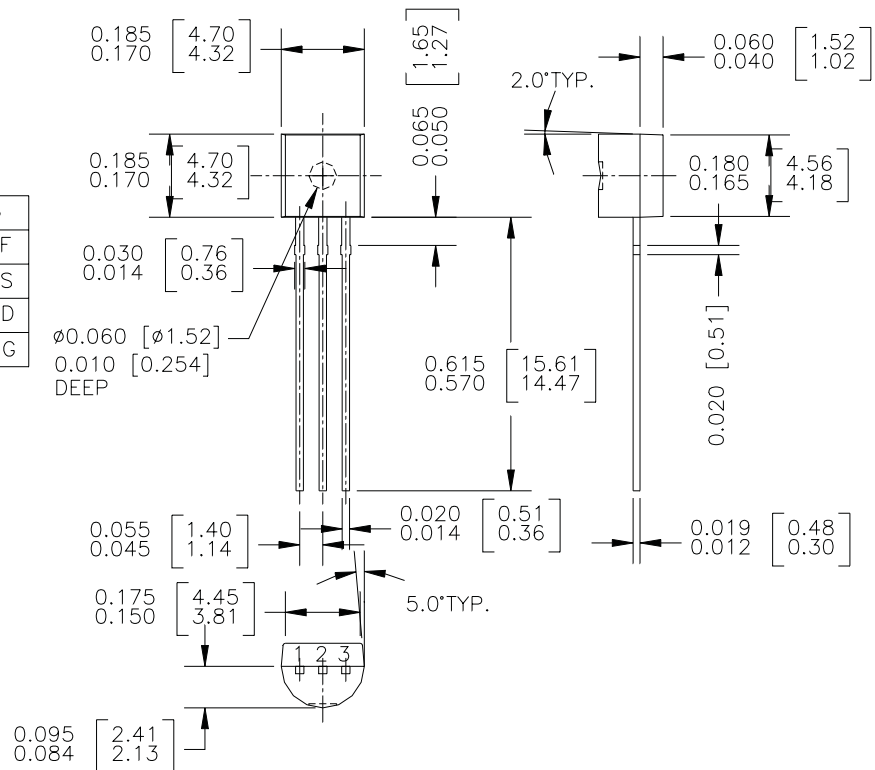

SOT-23 Tape and Reel Data



SOT-23 Packaging Configuration: Figure 10

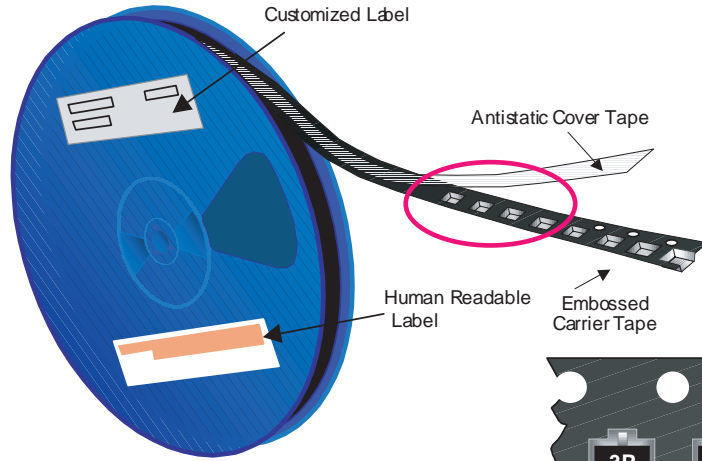

Packaging Description:

SOT-23 parts are shipped in tape. The carrier tape is made from a dissipative (carbon filled) polycarbonate resin. The cover tape is a multilayer film (Heat Activated Adhesive in nature) primarily composed of polyester film, adhesive layer, sealant, and anti-static sprayed agent. These reeled parts in standard option are shipped with 3,000 units per 7" or 177mm diameter reel. The reels are dark blue in color and is made of polystyrene plastic (anti-static coated). Other option comes in 10,000 units per 13" or 330mm diameter reel. This and some other options are described in the Packaging Information table.

These full reels are individually labeled and placed inside a standard intermediate made of recyclable corrugated brown paper with a Fairchild logo printing. One pizza box contains eight reels maximum. And these intermediate boxes are placed inside a labeled shipping box which comes in different sizes depending on the number of parts shipped.

SOT-23 Packaging Information		
Packaging Option	Standard (no flow code)	D87Z
Packaging type	TNR	TNR
Qty per Reel/Tube/Bag	3,000	10,000
Reel Size	7" Dia	13"
Box Dimension (mm)	187x107x183	343x343x64
Max qty per Box	24,000	30,000
Weight per unit (gm)	0.0082	0.0082
Weight per Reel (kg)	0.1175	0.4006
Note/Comments		

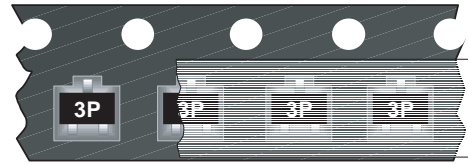

SOT-23 Unit Orientation

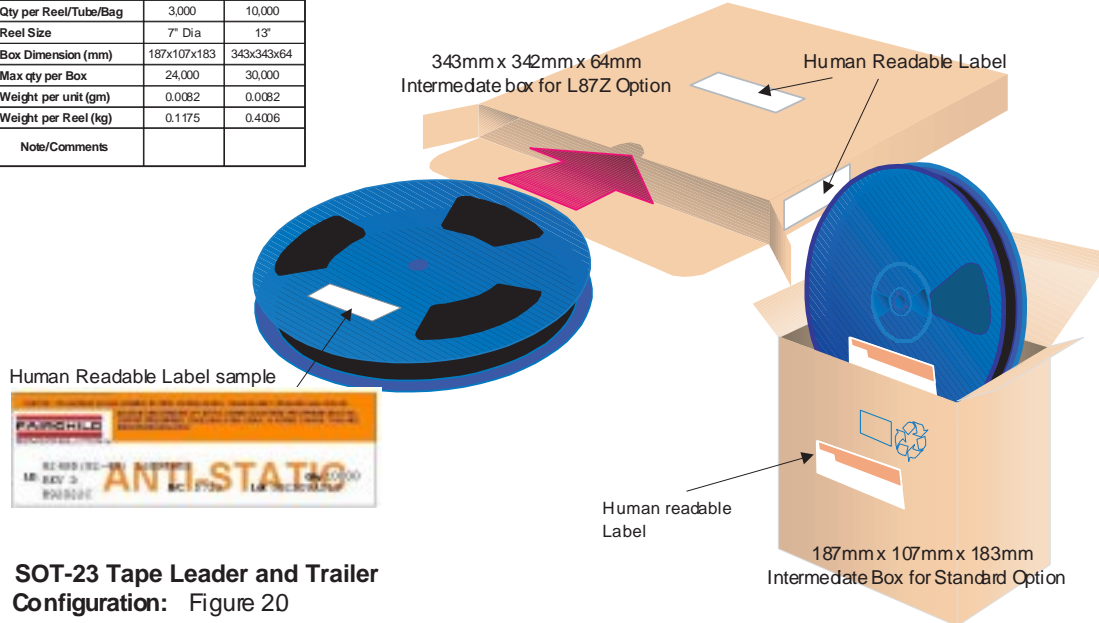

SOT-23 Tape Leader and Trailer Configuration: Figure 20

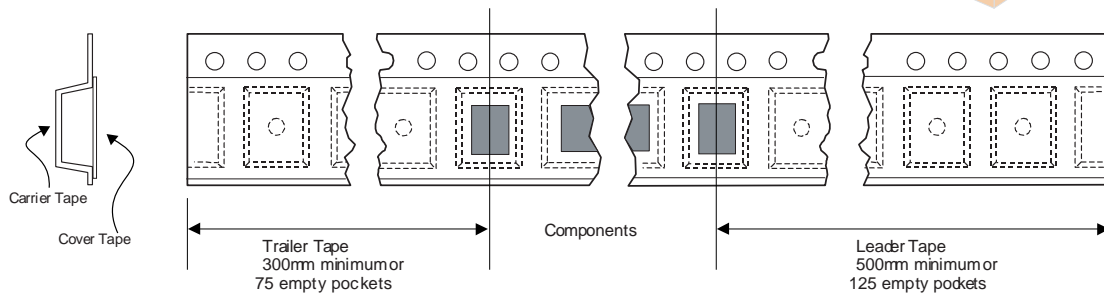

SOT-23 Tape and Reel Data, continued

SOT-23 Embossed Carrier Tape Configuration: Figure 3.0

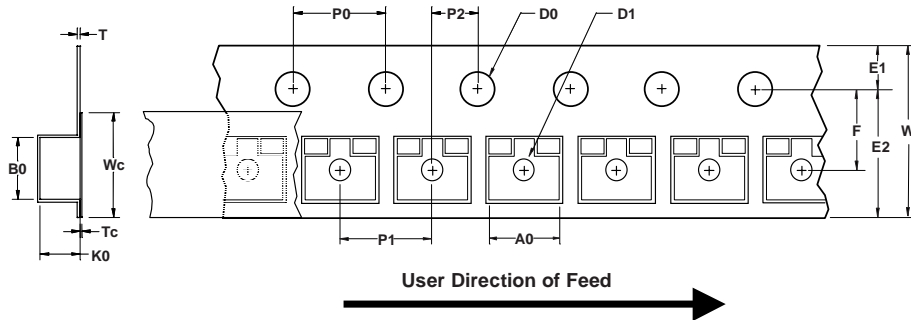

Dimensions are in millimeter														
Pkg type	A0	B0	W	D0	D1	E1	E2	F	P1	P0	K0	T	Wc	Tc
SOT-23 (8mm)	3.15 ±0.10	2.77 ±0.10	8.0 ±0.3	1.55 ±0.05	1.125 ±0.125	1.75 ±0.10	6.25 min	3.50 ±0.05	4.0 ±0.1	4.0 ±0.1	1.30 ±0.10	0.228 ±0.013	5.2 ±0.3	0.06 ±0.02

Notes: A0, B0, and K0 dimensions are determined with respect to the EIA/Jedec RS-481 rotational and lateral movement requirements (see sketches A, B, and C).

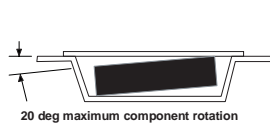

Sketch A (Side or Front Sectional View)
Component Rotation

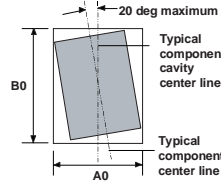

Sketch B (Top View)
Component Rotation

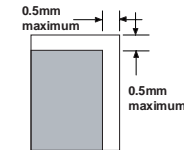

Sketch C (Top View)
Component lateral movement

SOT-23 Reel Configuration: Figure 4.0

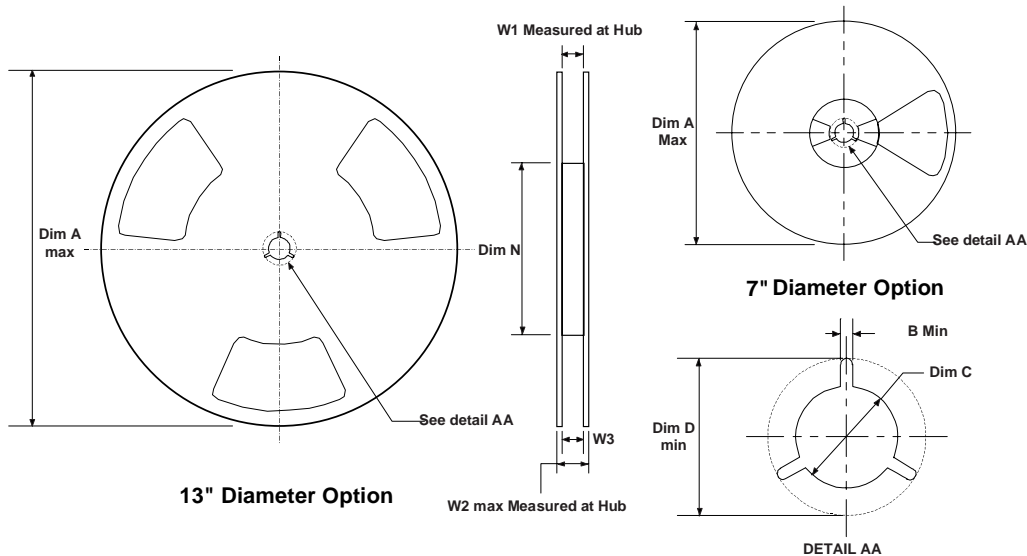

Dimensions are in inches and millimeters									
Tape Size	Reel Option	Dim A	Dim B	Dim C	Dim D	Dim N	Dim W1	Dim W2	Dim W3 (LSL-USL)
8mm	7" Dia	7.00 177.8	0.059 1.5	512 +0.020/-0.008 13 +0.5/-0.2	0.795 20.2	2.165 55	0.331 +0.059/-0.000 8.4 +1.5/0	0.567 14.4	0.311 -0.429 7.9 - 10.9
8mm	13" Dia	13.00 330	0.059 1.5	512 +0.020/-0.008 13 +0.5/-0.2	0.795 20.2	4.00 100	0.331 +0.059/-0.000 8.4 +1.5/0	0.567 14.4	0.311 -0.429 7.9 - 10.9

SOT-23 Package Dimensions



SOT-23 (FS PKG Code 49)

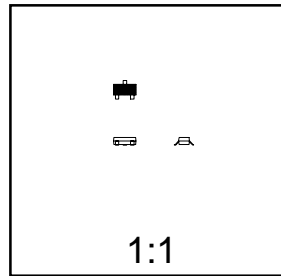
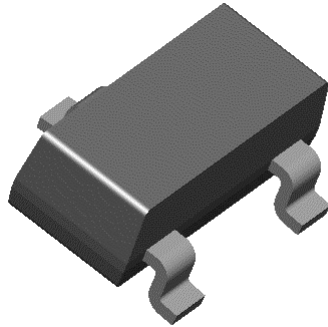

Scale 1:1 on letter size paper

Dimensions shown below are in:
inches [millimeters]

Part Weight per unit (gram): 0.0082

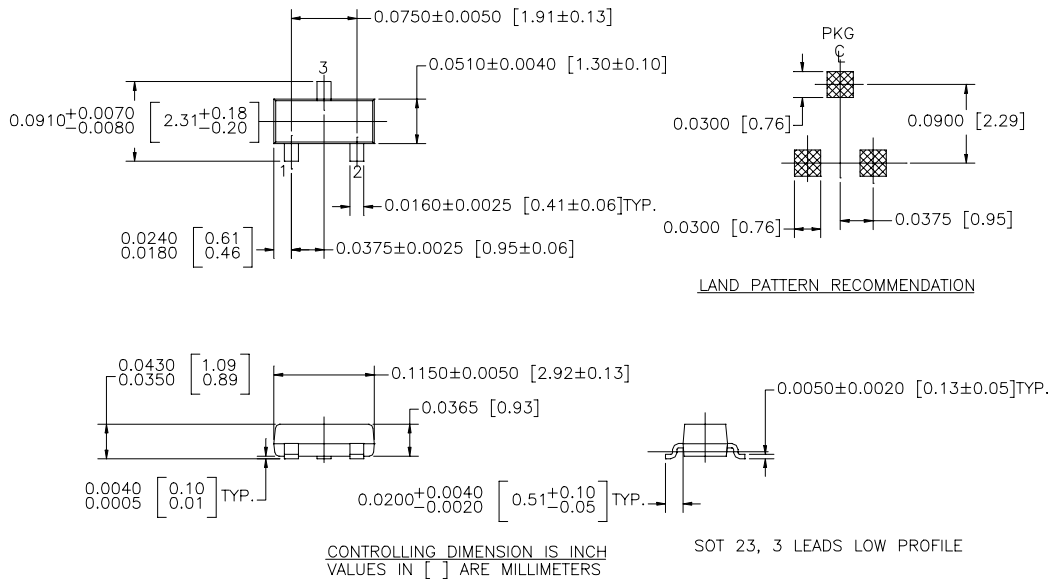

NOTE : UNLESS OTHERWISE SPECIFIED

- STANDARD LEAD FINISH 150 MICRONS / 3.81 MICROMETERS
MINIMUM TIN / LEAD (SOLDER) ON ALLOY 42
- REFERENCE JEDEC REGISTRATION TO-236, VARIATION AB, ISSUE G, DATED JUL 1993

SOT-223 Tape and Reel Data



SOT-223 Packaging Configuration: Figure 1.0

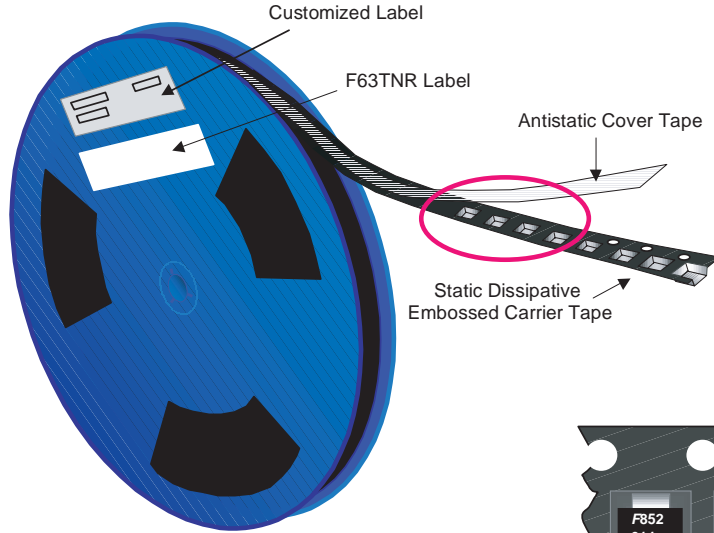

Packaging Description:
SOT-223 parts are shipped in tape. The carrier tape is made from a dissipative (carbon filled) polycarbonate resin. The cover tape is a multilayer film (Heat Activated Adhesive in nature) primarily composed of polyester film, adhesive layer, sealant, and anti-static sprayed agent. These reeled parts in standard option are shipped with 2,500 units per 13" or 330cm diameter reel. The reels are dark blue in color and is made of polystyrene plastic (anti-static coated). Other option comes in 500 units per 7" or 177cm diameter reel. This and some other options are further described in the Packaging Information table.
These full reels are individually barcode labeled and placed inside a standard intermediate box (illustrated in figure 1.0) made of recyclable corrugated brown paper. One box contains two reels maximum. And these boxes are placed inside a barcode labeled shipping box which comes in different sizes depending on the number of parts shipped.

SOT-223 Packaging Information		
Packaging Option	Standard (no flow code)	D84Z
Packaging type	TNR	TNR
Qty per Reel/Tube/Bag	2,500	500
Reel Size	13" Dia	7" Dia
Box Dimension (mm)	343x64x343	184x187x47
Max qty per Box	5,000	1,000
Weight per unit (gm)	0.1246	0.1246
Weight per Reel (kg)	0.7250	0.1532
Note/Comments		

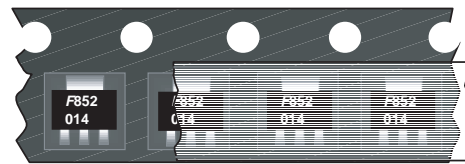

SOT-223 Unit Orientation

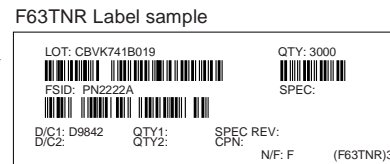
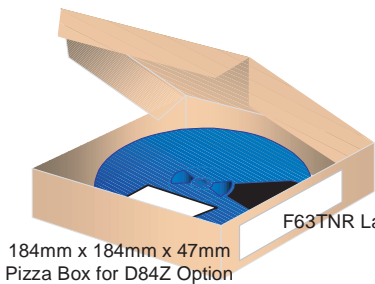
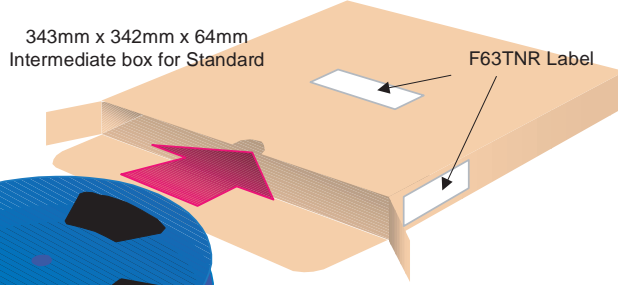

SOT-223 Tape Leader and Trailer Configuration: Figure 2.0

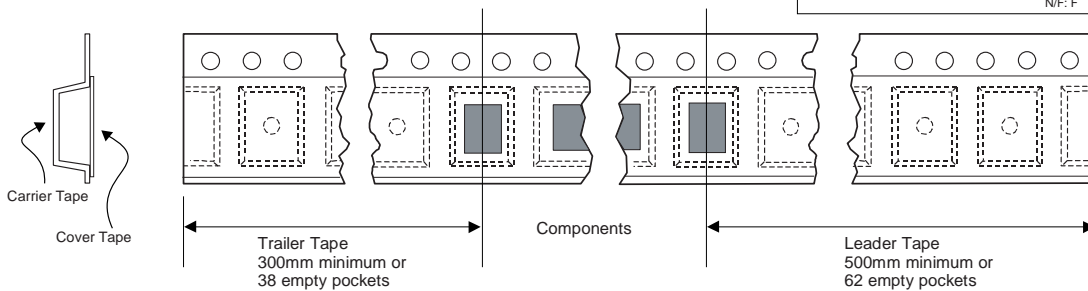

SOT-223 Package Dimensions



SOT-223 (FS PKG Code 47)

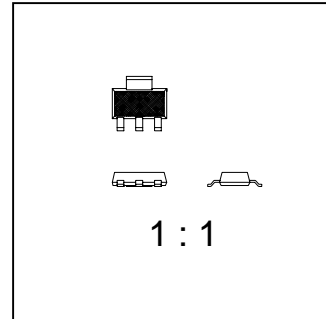
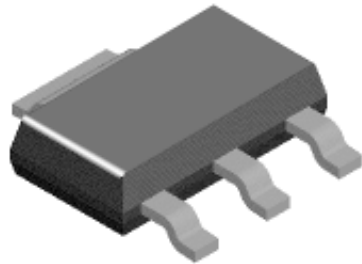

Scale 1:1 on letter size paper

Part Weight per unit (gram): 0.1246

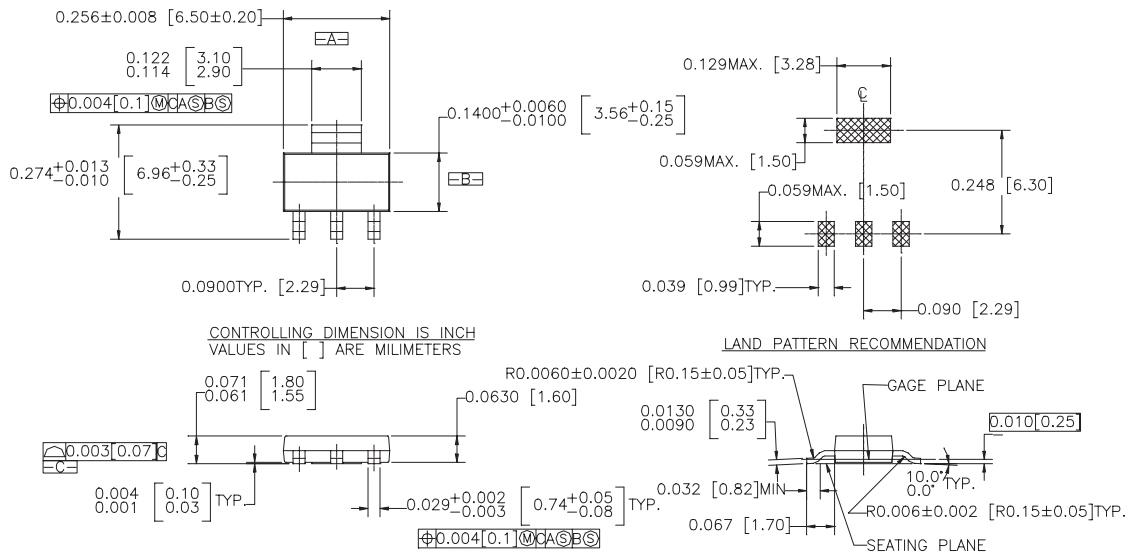

- NOTES : UNLESS OTHERWISE SPECIFIED
- STANDARD LEAD FINISH TO BE 150 MICRONS/ 3.81 MICROMETERS MINIMUM TIN/LEAD (SOLDER) ON COPPER.
 - REFERENCE JEDEC REGISTRATION TO-261, VARIATION AA, ISSUE A, DATED JAN 1990

SOT223, 4 LEADS

TRADEMARKS

The following are registered and unregistered trademarks Fairchild Semiconductor owns or is authorized to use and is not intended to be an exhaustive list of all such trademarks.

ACEx™	FASTr™	PowerTrench®	SyncFET™
Bottomless™	GlobalOptoisolator™	QFET™	TinyLogic™
CoolFET™	GTO™	QS™	UHC™
CROSSVOLT™	HiSeC™	QT Optoelectronics™	VCX™
DOME™	ISOPLANAR™	Quiet Series™	
E ² CMOS™	MICROWIRE™	SILENT SWITCHER®	
EnSigna™	OPTOLOGIC™	SMART START™	
FACT™	OPTOPLANAR™	SuperSOT™-3	
FACT Quiet Series™	PACMAN™	SuperSOT™-6	
FAST®	POP™	SuperSOT™-8	

DISCLAIMER

FAIRCHILD SEMICONDUCTOR RESERVES THE RIGHT TO MAKE CHANGES WITHOUT FURTHER NOTICE TO ANY PRODUCTS HEREIN TO IMPROVE RELIABILITY, FUNCTION OR DESIGN. FAIRCHILD DOES NOT ASSUME ANY LIABILITY ARISING OUT OF THE APPLICATION OR USE OF ANY PRODUCT OR CIRCUIT DESCRIBED HEREIN; NEITHER DOES IT CONVEY ANY LICENSE UNDER ITS PATENT RIGHTS, NOR THE RIGHTS OF OTHERS.

LIFE SUPPORT POLICY

FAIRCHILD'S PRODUCTS ARE NOT AUTHORIZED FOR USE AS CRITICAL COMPONENTS IN LIFE SUPPORT DEVICES OR SYSTEMS WITHOUT THE EXPRESS WRITTEN APPROVAL OF FAIRCHILD SEMICONDUCTOR CORPORATION. As used herein:

1. Life support devices or systems are devices or systems which, (a) are intended for surgical implant into the body, or (b) support or sustain life, or (c) whose failure to perform when properly used in accordance with instructions for use provided in the labeling, can be reasonably expected to result in significant injury to the user.
2. A critical component is any component of a life support device or system whose failure to perform can be reasonably expected to cause the failure of the life support device or system, or to affect its safety or effectiveness.

PRODUCT STATUS DEFINITIONS

Definition of Terms

Datasheet Identification	Product Status	Definition
Advance Information	Formative or In Design	This datasheet contains the design specifications for product development. Specifications may change in any manner without notice.
Preliminary	First Production	This datasheet contains preliminary data, and supplementary data will be published at a later date. Fairchild Semiconductor reserves the right to make changes at any time without notice in order to improve design.
No Identification Needed	Full Production	This datasheet contains final specifications. Fairchild Semiconductor reserves the right to make changes at any time without notice in order to improve design.
Obsolete	Not In Production	This datasheet contains specifications on a product that has been discontinued by Fairchild semiconductor. The datasheet is printed for reference information only.

find products

Home >> Find products >>

Products groups

- [Analog and Mixed Signal](#)
- [Discrete Interface](#)
- [Logic](#)
- [Microcontrollers](#)
- [Non-Volatile Memory](#)
- [Optoelectronics](#)
- [Markets and applications](#)
- [New products](#)
- [Product selection and parametric search](#)
- [Cross-reference search](#)

technical information

buy products

technical support

my Fairchild

company

2N3904
NPN General Purpose Amplifier

Contents
[General description](#) | [Product status/pricing/packaging](#) | [Models](#) | [Application notes](#)

General description

This device is designed as a general purpose amplifier and switch. The useful dynamic range extends to 100 mA as a switch and to 100 MHz as an amplifier.

[back to top](#)

Product status/pricing/packaging

Datasheet
[Download this datasheet](#)

PDF

[e-mail this datasheet](#)

[E-mail]

This page [Print version](#)

Related Links

- [Request samples](#)
- [Dotted line](#)
- [How to order products](#)
- [Dotted line](#)
- [Product Change Notices \(PCNs\)](#)
- [Dotted line](#)
- [Support](#)
- [Dotted line](#)
- [Distributor and field sales representatives](#)
- [Dotted line](#)
- [Quality and reliability](#)
- [Dotted line](#)
- [Design tools](#)

Product	Product status	Pricing*	Package type	Leads	Package marking	Packing method
2N3904BU	Full Production	\$0.045	TO-92	3	N/A	BULK
2N3904CBU	Full Production	\$0.045	TO-92	3	N/A	BULK
2N3904RP	Full Production	\$0.073	TO-92	3	\$Y&3 2N 3904	AMMO
2N3904RM	Full Production	\$0.073	TO-92	3	\$Y&3 2N 3904	AMMO
2N3904RA	Full Production	\$0.073	TO-92	3	\$Y&3 2N 3904	TAPE REEL
2N3904CHBU	Full Production	\$0.045	TO-92	3	N/A	BULK
2N3904CTA	Full Production	\$0.045	TO-92	3	N/A	TAPE REEL
2N3904TA	Full Production	\$0.045	TO-92	3	N/A	TAPE REEL
2N3904TF	Full Production	\$0.045	TO-92	3	N/A	TAPE REEL
2N3904	Full Production	\$0.073	TO-92	3	\$Y&3 2N 3904	BULK

* 1,000 piece Budgetary Pricing

[back to top](#)

Models

Package & leads	Condition	Temperature range	Software version	Revision date
PSPICE				
TO-92-3	Electrical	25°C	N/A	N/A

[back to top](#)

▪

Application notes

[AN-257: Simplified Multi-Digit LED Display Design Using MM74C911 and MM74C912 Display Controllers](#) (259 K) Jul 12, 2002

[AN-4111: AN-4111 Fairchild Power Switch Single Chip FSDH Series for Charger and Adapter Use](#) (1497 K) Jul 12, 2002

[AN-3008: AN-3008 RC Snubber Networks for Thyristor Power Control and Transient Suppression](#) (930 K) Jul 12, 2002

[AN-42034: AN-42034 Synchronizing the ML4824 to Wide Frequency Ranges](#) (119 K) Jul 12, 2002

[AN-42037: AN-42037 ML4423 Application Guidelines](#) (295 K) Jul 12, 2002

[back to top](#)

▪

[Home](#) | [Find products](#) | [Technical information](#) | [Buy products](#) | [Support](#) | [Company](#) | [Contact us](#) | [Site index](#) | [Privacy policy](#)

© Copyright 2002 Fairchild Semiconductor
