

RoHS  **TMOV®25S Varistor Series**

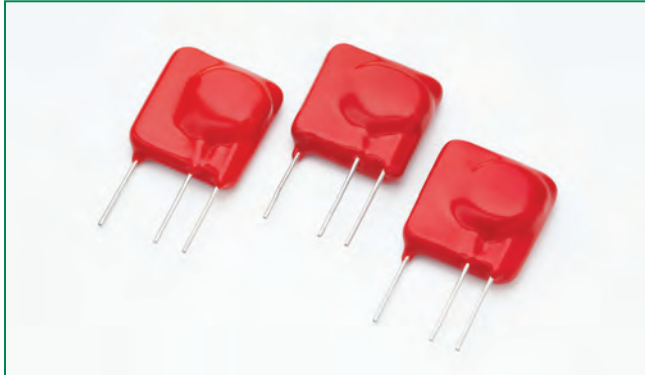

Description



Metal Oxide Varistors (MOVs) are rated for specific AC line operating voltages, and exceeding these limits through the application of a sustained abnormal over-voltage condition could result in overheating and damage to the MOV.

The Littelfuse TMOV®25S (Thermal MOV) Series was designed to address this condition in a single integrated package.

The TMOV®25S Series incorporates a patented integrated thermally responsive element within the body of the device which will open-circuit the varistor in case of overheating due to the abnormal over-voltage events.

The TMOV®25S Series is based on the Littelfuse UltraMOV™ 25S Series, which meets the surge suppressor component recognition requirements of UL1449 3rd edition for both cord connected and permanently connected SPD end products.

Agency Approvals

Agency	Agency File Number	Status
	UL1449 3rd Edition	E320116
	IEC-CECC Spec: QC42201-C001, QC42201-A001, IEC 60950-1 (Annex Q)	E1274/F
	IEC 61051-1, IEC 61051-2, IEC 60950-1 (Annex Q)	40021525

Features

- RoHS Compliant and Lead-free
- Patented integrated thermal protection device - Patent #US6636403
- Wave solderable
- Standard Operating Voltage Range Compatible with Common AC Line Voltages (115VAC to 750VAC)
- High peak surge current rating up to 20kA at single 8/20µS impulse
- Standard lead form and spacing option
- -55°C to +85°C operating temperature range

Applications

- SPD Products
- AC Panel Protection Modules
- AC Line Power Supplies
- Surge Protected Strip Connectors
- AC Power Meters
- Inverters, AC/DC power supplies, etc.
- UPS (Uninterruptible Power Supply)

TMOV®25S Series

Absolute Maximum Ratings

• For ratings of individual members of a series, see Device Ratings and Specifications chart.

	TMOV®25S Series	Units
Continuous:		
AC Voltage Range ($V_{M(AC)RMS}$)	115 to 750	V
Transient:		
Peak Pulse Current (I_{TM})		
For 8x20µs Current Wave, single pulse	20,000	A
Single-Pulse Energy Capability		
For 2ms Current Wave	170 to 670	J
Operating Ambient Temperature Range (T_A)	-55 to +85	°C
Storage Temperature Range (T_{STG})	-55 to +125	°C
Temperature Coefficient (αV) of Clamping Voltage (V_C) at Specified Test Current	<0.01	%/°C
Hi-Pot Encapsulation (COATING Isolation Voltage Capability)	2,500	V
Thermal Protection Isolation Voltage Capability (when operated)	600*	V
*See notes under Device Ratings & Specifications section for more information		
COATING Insulation Resistance	1,000	MΩ

CAUTION: Stresses above those listed in "Absolute Maximum Ratings" may cause permanent damage to the device. This is a stress only rating and operation of the device at these or any other conditions above those indicated in the operational sections of this specification is not implied.

Device Ratings & Specifications

Part Number	Branding	Model Size Disc Diameter (mm)	Maximum Rating (85°C)				Specifications (25 °C)			
			Continuous		Transient		Varistor Voltage at 1mA Test Current		Clamping Voltage at 100A Current 8/20µs	Typical Capacitance (f=1MHz)
			AC Volts	DC Volts	Energy 2ms	Peak Current 8/20µs				
			$V_{M(AC)RMS}$	$V_{M(DC)}$	W_{TM}	$I_{TM} 1 \times \text{Pulse}$	$V_{N(DC)} \text{ Min}$	$V_{N(DC)} \text{ Max}$	V_C	C
			(V)	(V)	(J)	(A)	(V)		(V)	(pF)
TMOV25SP115M	P25T115M	25	115	150	170	20000	162	198	295	3200
TMOV25SP130M	P25T130M	25	130	170	190	20000	184	226	335	2800
TMOV25SP140M	P25T140M	25	140	180	210	20000	200	240	355	2500
TMOV25SP150M	P25T150M	25	150	200	220	20000	216	264	390	2300
TMOV25SP175M	P25T175M	25	175	225	250	20000	243	297	450	1900
TMOV25SP200M	P25T200M	25	200	265	270	20000	281	344	530	1700
TMOV25SP230M	P25T230M	25	230	300	300	20000	324	396	585	1500
TMOV25SP250M	P25T250M	25	250	320	330	20000	351	429	640	1400
TMOV25SP275M	P25T275M	25	275	350	350	20000	387	473	700	1250
TMOV25SP300M	P25T300M	25	300	385	370	20000	423	517	765	1150
TMOV25SP320M	P25T320M	25	320	420	390	20000	459	561	825	1080
TMOV25SP385M	P25T385M	25	385	505	430	20000	558	682	1010	900
TMOV25SP420M	P25T420M	25	420	560	460	20000	612	748	1100	820
TMOV25SP440M	P25T440M	25	440	585	470	20000	643	787	1160	790
TMOV25SP460M	P25T460M	25	460	615	490	20000	675	825	1220	750
TMOV25SP510M	P25T510M	25	510	670	520	20000	738	902	1335	680
TMOV25SP550M	P25T550M	25	550	745	550	20000	819	1001	1475	630
TMOV25SP625M	P25T625M	25	625	825	600	20000	900	1100	1625	550
TMOV25SP750M	P25T750M	25	750	970	670	20000	1080	1320	1950	460

Notes:
Average power dissipation of transients should not exceed 1.5 watts.

Thermal Characteristics

Typical time to open circuit under UL 1449 Abnormal Overvoltage Limited Current Test:

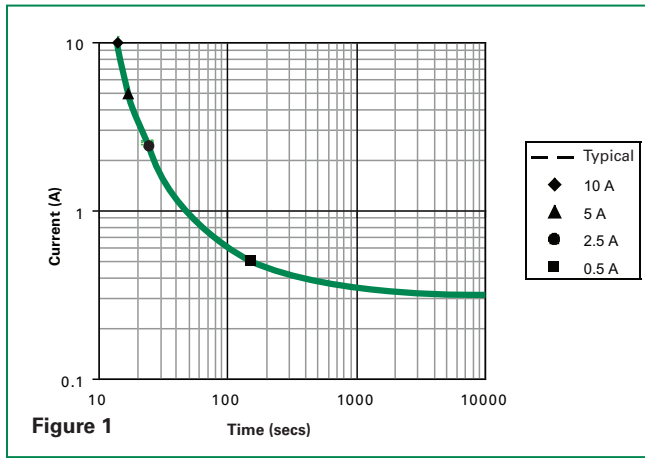

Figure 1

Current, Energy, Power Derating Curve

For applications exceeding 85°C ambient temperature, the peak surge current and energy ratings must be reduced as shown below.

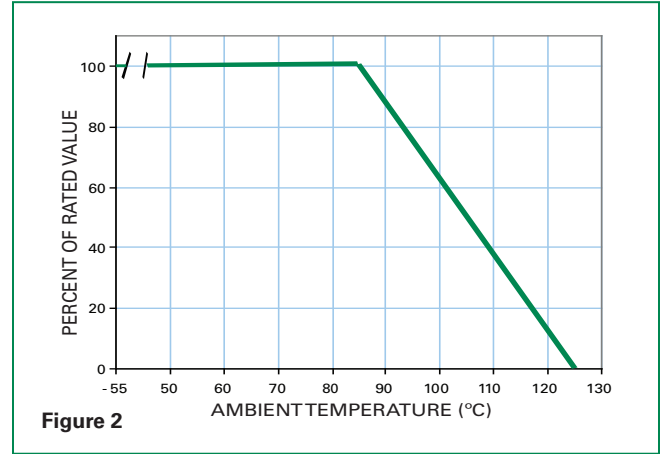

Figure 2

Transient V-I Characteristic Curves

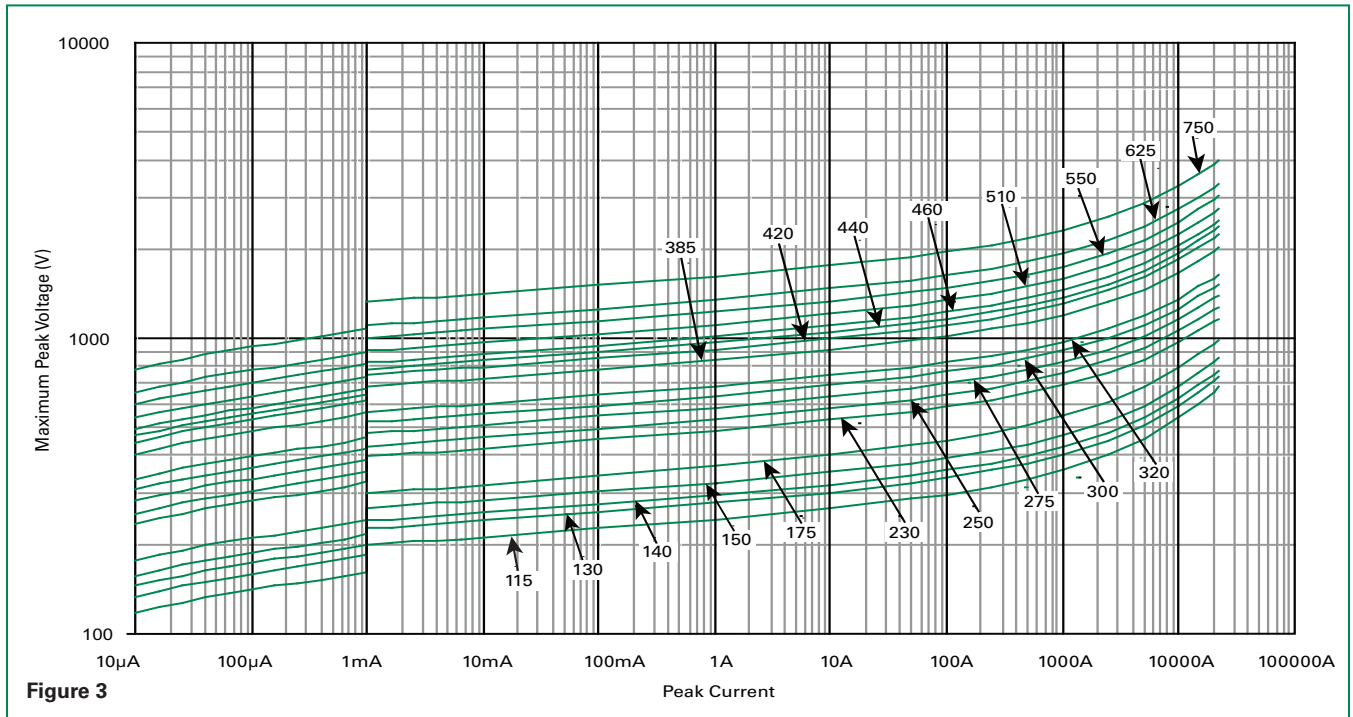

Figure 3

TMOV®25S Series

Pulse Rating Curve

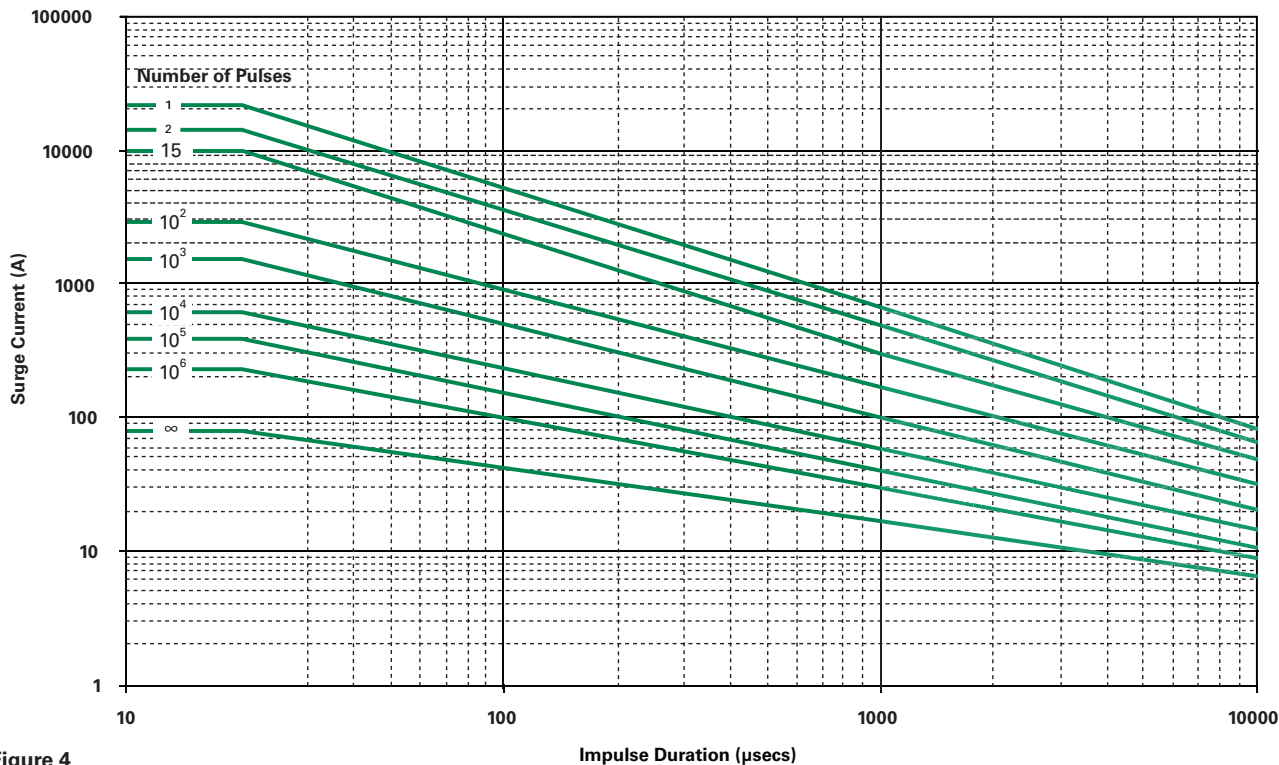

Figure 4

Wave Solder Profile

Because the TMOV®25S Series contains a thermally responsive device, care must be taken when soldering the device into place. Two soldering methods are possible. Firstly, hand soldering: We recommend the use of pliers to heat-sink the leads of the device. Secondly, wave-soldering: This is a strenuous process requiring pre-heat stages to reduce the stresses on devices.

It is critically important that all preheat stage and the solder bath temperatures are rigidly controlled. The recommended solder for the TMOV® Series is a 62/36/2 (Sn/Pb/Ag), 60/40 (Sn/Pb) or 63/37 (Sn/Pb). Littelfuse also recommends an RMA solder flux. SAC solders (SnAgCu) are recommended for Lead-free applications.

Soldering Profile

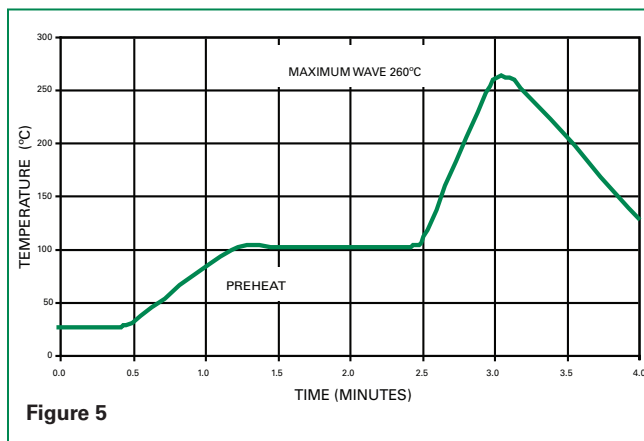

Figure 5

Physical Specifications

Lead Material	Tin-coated Copper wire
Soldering Characteristics	Solderability per MIL-STD-202, Method 208E
Insulating Material	Cured, flame retardant epoxy polymer meets UL94V-0 requirements
Device Labeling	Marked with LF, voltage, UL logos, and date code

Environmental Specifications

Operating/Storage Temperature	-40°C to +85°C
Passive Aging	+85°C, 1000 hours -/+10% typical voltage change
Humidity Aging	+85°C, 85%R.H., 1000 hours -/+10% typical voltage change
Thermal Shock	+85°C to -40°C 5 times -/+10% typical voltage change
Solvent Resistance	MIL-STD-202, Method 215F
Moisture Sensitivity	Level 1, J-STD-020C

Application Example

The application example left shows how the indicator lead on the TMOV® can be used to indicate that thermal element has been opened. This signifies that the circuit is no longer protected from transients by the MOV.

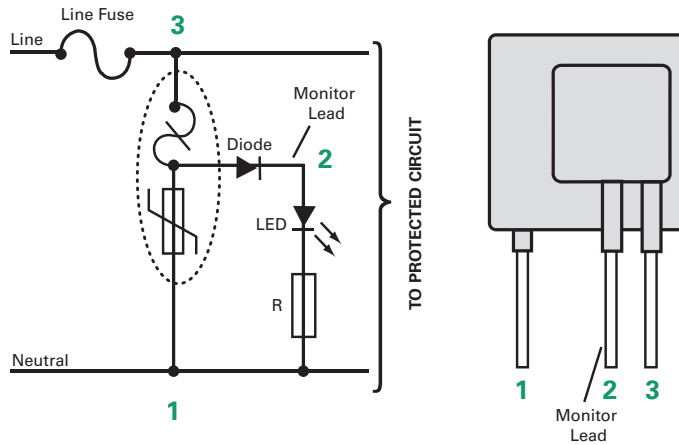

Dimensions

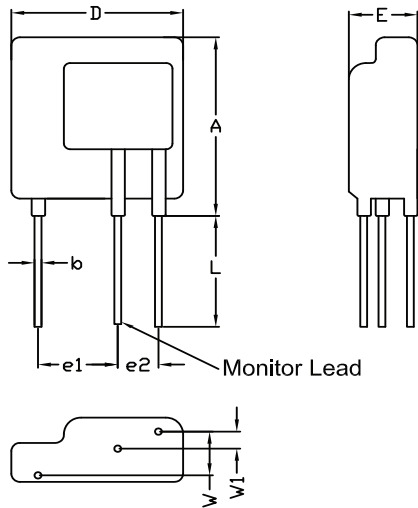

Product Dimensions (mm)

Part Number	W _{MIN}	W _{MAX}	E _{MAX}	A _{MAX}	b _{MIN}	b _{MAX}	D _{MAX}	e1	e2	W1	L
TMOV25SP115M	1.5	2.7	11.7	34.5	0.95	1.05	28	12.7+/-1	6.5+/-1	2.5+/-1	12.7 Min.
TMOV25SP130M	1.6	2.9	11.9								
TMOV25SP140M	1.7	3.0	12.0								
TMOV25SP150M	1.8	3.1	12.1								
TMOV25SP175M	1.9	3.3	12.3								
TMOV25SP200M	1.9	3.3	12.3								
TMOV25SP230M	2.0	3.4	12.4								
TMOV25SP250M	2.1	3.5	12.5								
TMOV25SP275M	2.3	3.7	12.7								
TMOV25SP300M	2.4	3.9	12.9								
TMOV25SP320M	2.6	4.1	13.1								
TMOV25SP385M	3.0	4.7	13.7								
TMOV25SP420M	3.3	5.0	14.0								
TMOV25SP440M	3.4	5.2	14.2								
TMOV25SP460M	3.6	5.4	14.4								
TMOV25SP510M	3.9	5.7	14.7								
TMOV25SP550M	4.2	6.2	15.2								
TMOV25SP625M	4.6	6.6	15.6								
TMOV25SP750M	5.4	7.7	16.7								

Part Numbering System

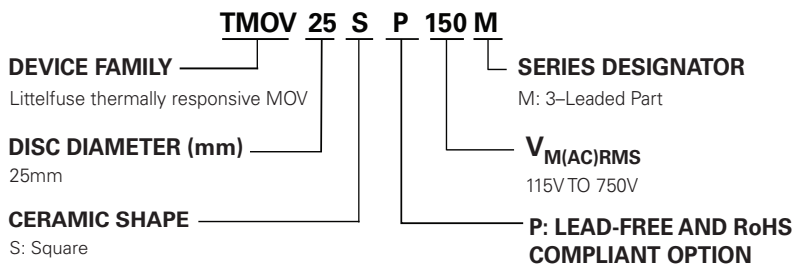

Term Definitions

Rated AC Voltage ($V_{M(AC)RMS}$) – MCOV

This is the maximum continuous sinusoidal RMS voltage that may be applied. This voltage may be applied at any temperature up to the maximum operating temperature of the device.

Maximum Non-Repetitive Surge Current (I_{TM})

This is the maximum peak current which may be applied for a single 8/20 μ s impulse, with rated line voltage also applied, without causing device failure. The pulse can be applied to the device in either polarity with the same confidence factor.

Nominal Discharge Current (I_N)

Peak value of the current, selected by the manufacturer, through the SPD having a current waveshape of 8/20 μ s where the SPD remains functional after 15 surges.

Voltage Protection Rating (V_{PR})

A rating selected from a list of preferred values as given in UL 1449 and assigned to each mode of protection. The value of VPR is determined as the nearest highest value taken from UL 1449 to the measured limiting voltage determined during the transient-voltage surge suppression test using the combination wave generator at a setting of 6kV, 3kA.

UL 1449

An Underwriters Laboratory standard covering the safety requirements for Surge Protective Devices intended for permanently connected, cord-connected and direct plug-in applications.

Limited Current Abnormal Over-voltage Test

An AC over-voltage condition applied to a Surge Protective Device according to UL 1449, Section 39.4. The short circuit current is limited by series connected resistors to 10A, 5A, 2.5A, 0.5A and 0.125A. The condition is maintained for 7 hours or until the device under test is disconnected from the AC supply or the current or temperature reaches equilibrium.

Maximum Non-Repetitive Surge Energy (W_{TM})

This is the maximum rated transient energy which may be dissipated for a single current pulse at a specified impulse duration, with the rated RMS voltage applied, without causing device failure.

Nominal Voltage ($V_{N(DC)}$)

This is the voltage at which the device changes from the off (standby state) to the on (clamping state) and enters its conduction mode of operation. The voltage value is usually characterised at the 1mA point and has a specified minimum and maximum voltage range.