



UTM4052

Power MOSFET

DUAL ENHANCEMENT MODE (N-CHANNEL/P-CHANNEL)

■ FEATURES

- * N-Channel: 40V/7.5A
 $R_{DS(ON)} = 30\text{ m}\Omega$ (typ.) @ $V_{GS} = 10\text{V}$
 $R_{DS(ON)} = 46\text{ m}\Omega$ (typ.) @ $V_{GS} = 5\text{V}$
- * P-Channel: -40V/-6A
 $R_{DS(ON)} = 45\text{ m}\Omega$ (typ.) @ $V_{GS} = -10\text{V}$
 $R_{DS(ON)} = 52\text{ m}\Omega$ (typ.) @ $V_{GS} = -5\text{V}$
- * Super High Dense Cell Design
- * Reliable and Rugged

■ SYMBOL

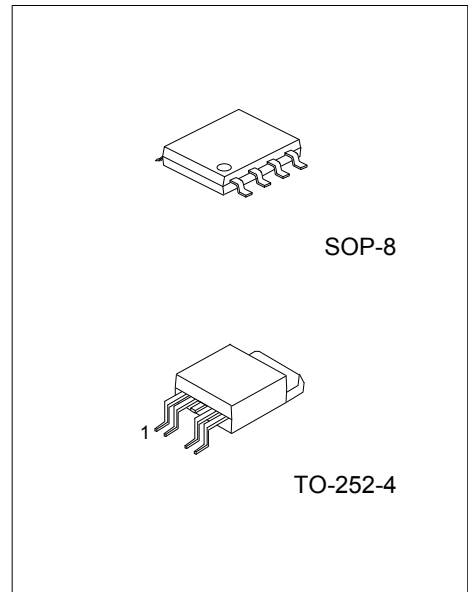
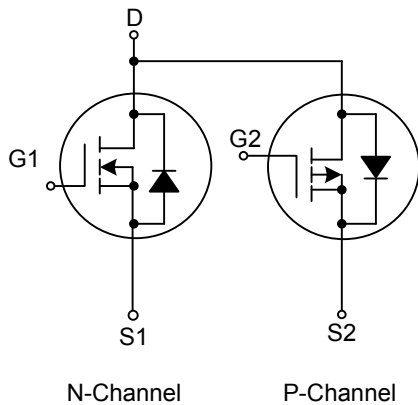

■ ORDERING INFORMATION

Ordering Number		Package	Pin Assignment								Packing
Lead Free	Halogen Free		1.	2.	3.	4.	5.	6.	7.	8.	
UTM4052L-S08-R	UTM4052G-S08-R	SOP-8	S1	G1	S2	G2	D	D	D	D	Tape Reel
UTM4052L-TN4-R	UTM4052G-TN4-R	TO-252-4	S1	G1	D	S2	G2	-	-	-	Tape Reel
UTM4052L-TN4-T	UTM4052G-TN4-T	TO-252-4	S1	G1	D	S2	G2	-	-	-	Tube

<p>UTM4052L-S08-R</p> <p>(1)Packing Type (2)Package Type (3)Lead Plating</p>	<p>(1) R: Tape Reel, T: Tube (2) S08: SOP-8, TN4: TO-252-4 (3) G: Halogen Free, L: Lead Free</p>
--	--

■ PIN CONFIGURATION

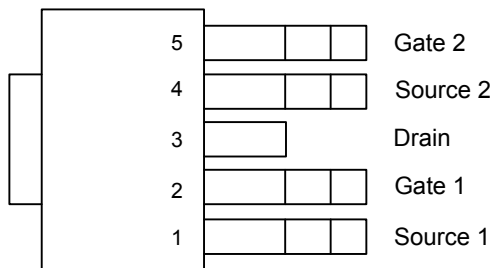

TO-252-4

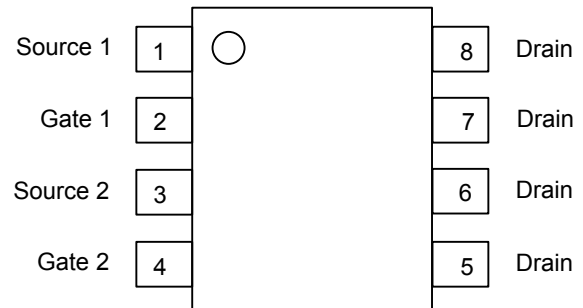

SOP-8

■ ABSOLUTE MAXIMUM RATINGS (Ta=25°C unless otherwise specified)

N-CHANNEL

PARAMETER		SYMBOL	RATINGS	UNIT
Drain-Source Voltage		V_{DS}	40	V
Gate-Source Voltage		V_{GS}	±20	V
Continuous Drain Current (Note 2)	$T_C=25^\circ\text{C}$	I_D	7.5	A
Pulsed Drain Current (Note 2)	$T_C=25^\circ\text{C}$	I_{DM}	30	A
Power Dissipation ($T_C=25^\circ\text{C}$)	SOP-8	P_D	3.1	W
	TO-252-4		25	W
Junction Temperature		T_J	+150	°C
Storage Temperature		T_{STG}	-55 ~ +150	°C

P-CHANNEL

PARAMETER		SYMBOL	RATINGS	UNIT
Drain-Source Voltage		V_{DS}	-40	V
Gate-Source Voltage		V_{GS}	±20	V
Continuous Drain Current (Note 2)	$T_C=25^\circ\text{C}$	I_D	-6	A
Pulsed Drain Current (Note 2)	$T_C=25^\circ\text{C}$	I_{DM}	-25	A
Power Dissipation ($T_C=25^\circ\text{C}$)	SOP-8	P_D	3.1	W
	TO-252-4		25	W
Junction Temperature		T_J	+150	°C
Storage Temperature		T_{STG}	-55 ~ +150	°C

Notes: 1. Absolute maximum ratings are those values beyond which the device could be permanently damaged.

Absolute maximum ratings are stress ratings only and functional device operation is not implied.

2. Surface Mounted on 1in² pad area, t≤10sec.

■ THERMAL DATA

PARAMETER		SYMBOL	RATINGS	UNIT
Junction to Ambient (Note)	SOP-8	θ_{JA}	78	°C/W
	TO-252-4		50	°C/W
Junction to Case	SOP-8	θ_{JC}	40	°C/W
	TO-252-4		5	°C/W

Note: Surface Mounted on 1in² pad area, t≤10sec.

■ ELECTRICAL CHARACTERISTICS (T_A=25°C, unless otherwise specified)

N-CHANNEL

PARAMETER	SYMBOL	TEST CONDITIONS	MIN	TYP	MAX	UNIT
OFF CHARACTERISTICS						
Drain-Source Breakdown Voltage	BV _{DSS}	V _{GS} =0V, I _D =250uA	40			V
Drain-Source Leakage Current	I _{DSS}	V _{DS} =32V, V _{GS} =0V			1	uA
Gate-Source Leakage Current	I _{GSS}	V _{DS} =0V, V _{GS} =±20V			±100	nA
ON CHARACTERISTICS						
Gate Threshold Voltage	V _{GS(TH)}	V _{DS} =V _{GS} , I _D =250uA	1.3	2	2.5	V
Drain-Source On-State Resistance (Note2)	R _{DS(ON)}	V _{GS} =10V, I _D =7.5A		30	38	mΩ
		V _{GS} =5V, I _D =5A		46	62	mΩ
DYNAMIC CHARACTERISTICS						
Input Capacitance	C _{ISS}	V _{GS} =0V, V _{DS} =20V, f=1.0MHz		480		pF
Output Capacitance	C _{OSS}			70		pF
Reverse Transfer Capacitance	C _{RSS}			50		pF
SWITCHING CHARACTERISTICS						
Turn-ON Delay Time (Note2)	t _{D(ON)}	V _{DS} =20V, V _{GS} =10V, I _D =1A, R _G =6Ω, R _L =20Ω		7	14	ns
Turn-ON Rise Time	t _R			10	19	ns
Turn-OFF Delay Time	t _{D(OFF)}			17	32	ns
Turn-OFF Fall Time	t _F			3	6	ns
Total Gate Charge (Note2)	Q _G	V _{DS} =20V, V _{GS} =10V, I _D =7.5A		17	24	nC
Gate-Source Charge	Q _{GS}			2.2		nC
Gate-Drain Charge	Q _{GD}			4		nC
SOURCE- DRAIN DIODE RATINGS AND CHARACTERISTICS						
Drain-Source Diode Forward Voltage(Note2)	V _{SD}	T _J =25°C, I _S =2A, V _{GS} =0V		0.8	1.1	V
Diode Continuous Forward Current (Note3)	I _S				20	A
Reverse Recovery Time	t _{RR}	I _{DS} =7.5A, dI/dt=100A/μs		21		ns
Reverse Recovery Charge	Q _{RR}			16		nC

P-CHANNEL

PARAMETER	SYMBOL	TEST CONDITIONS	MIN	TYP	MAX	UNIT
OFF CHARACTERISTICS						
Drain-Source Breakdown Voltage	BV _{DSS}	V _{GS} =0V, I _D =-250uA	-40			V
Drain-Source Leakage Current	I _{DSS}	V _{DS} =-32V, V _{GS} =0V			-1	uA
Gate-Source Leakage Current	I _{GSS}	V _{DS} =0V, V _{GS} =±20V			±100	nA
ON CHARACTERISTICS						
Gate Threshold Voltage	V _{GS(TH)}	V _{DS} =V _{GS} , I _D =-250uA	-1.3	-2	-2.5	V
Drain-Source On-State Resistance (Note2)	R _{DS(ON)}	V _{GS} =-10V, I _D =-6A		45	50	mΩ
		V _{GS} =-5V, I _D =-3.5A		52	73	mΩ
DYNAMIC CHARACTERISTICS						
Input Capacitance	C _{ISS}	V _{GS} =0V, V _{DS} =-20V, f=1.0MHz		970		pF
Output Capacitance	C _{OSS}			100		pF
Reverse Transfer Capacitance	C _{RSS}			70		pF
SWITCHING CHARACTERISTICS						
Turn-ON Delay Time (Note2)	t _{D(ON)}	V _{DS} =-20V, V _{GS} =-10V, I _D =-1A, R _G =6Ω, R _L =20Ω		5	10	ns
Turn-ON Rise Time	t _R			11	21	ns
Turn-OFF Delay Time	t _{D(OFF)}			37	68	ns
Turn-OFF Fall Time	t _F			12	23	ns
Total Gate Charge (Note2)	Q _G	V _{DS} =-20V, V _{GS} =-10V, I _D =-6A		17	24	nC
Gate-Source Charge	Q _{GS}			2.2		nC
Gate-Drain Charge	Q _{GD}			4		nC

■ ELECTRICAL CHARACTERISTICS(Cont.)

PARAMETER	SYMBOL	TEST CONDITIONS	MIN	TYP	MAX	UNIT
SOURCE- DRAIN DIODE RATINGS AND CHARACTERISTICS						
Drain-Source Diode Forward Voltage(Note2)	V_{SD}	$T_J=25^{\circ}C, I_S=-2A, V_{GS}=0V$		-0.8	-1.1	V
Diode Continuous Forward Current (Note3)	I_S				-18	A
Reverse Recovery Time	t_{RR}	$I_{DS}=-6A, di/dt=100A/\mu s$		17		ns
Reverse Recovery Charge	Q_{RR}			10		nC

- Notes: 1. Pulse width limited by $T_{J(MAX)}$
 2. Pulse width $\leq 300\mu s$, duty cycle $\leq 2\%$.
 3. Surface Mounted on $1in^2$ pad area, $t \leq 10sec$.

TYPICAL CHARACTERISTICS

N-CHANNEL

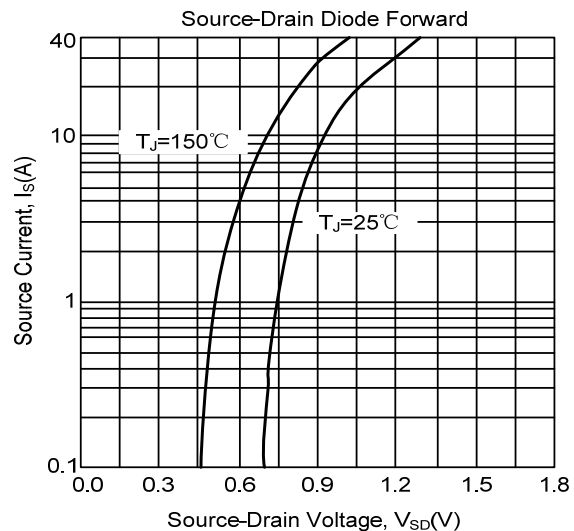
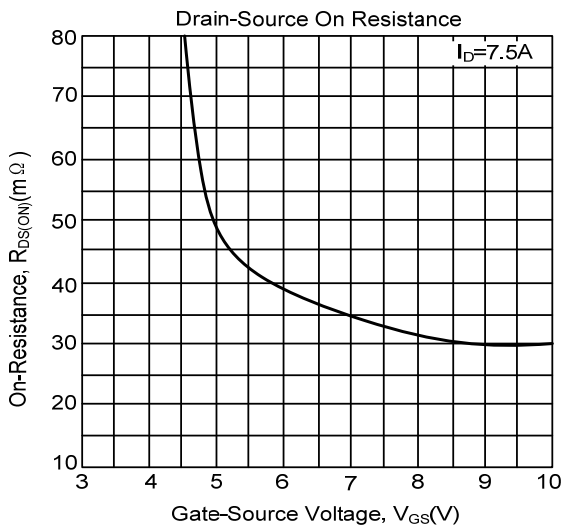
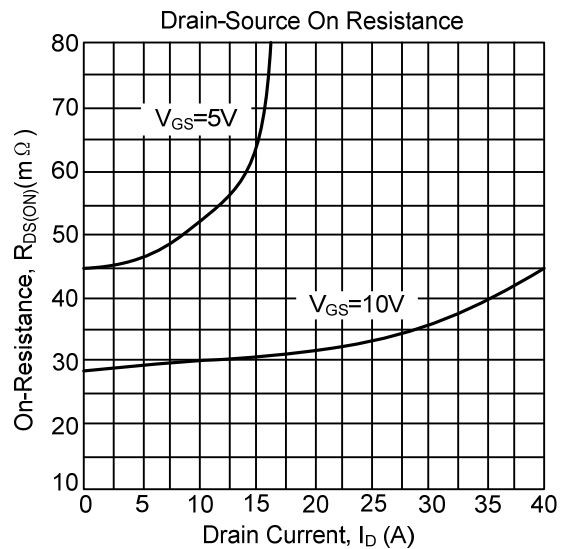
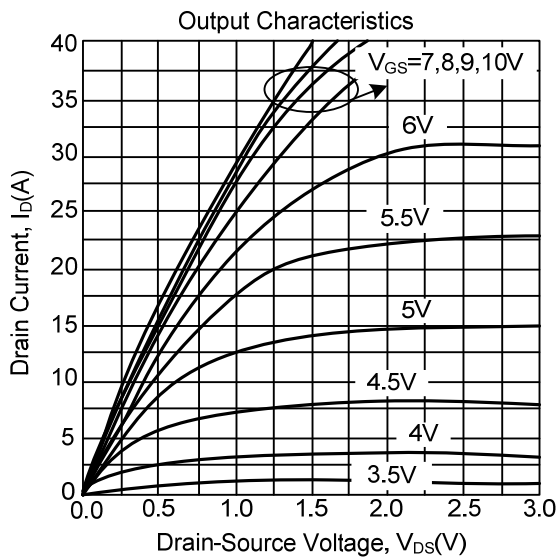
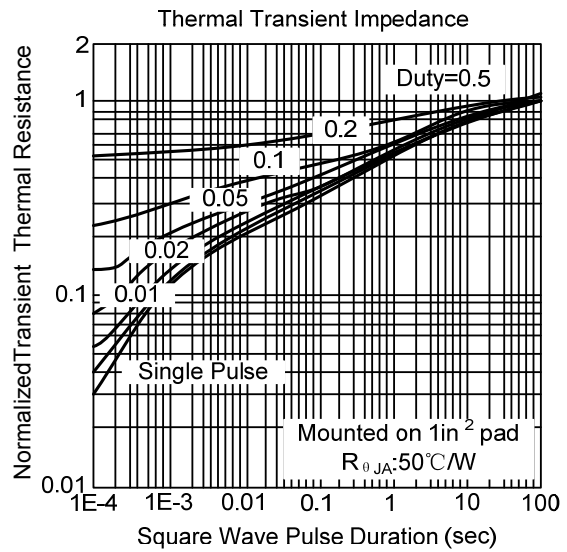
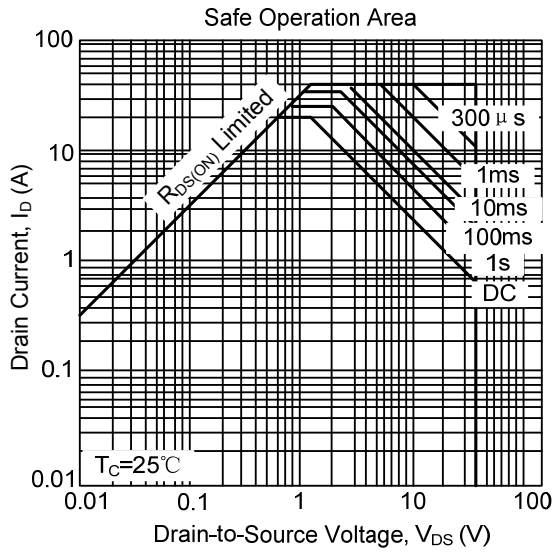

TYPICAL CHARACTERISTICS(Cont.)

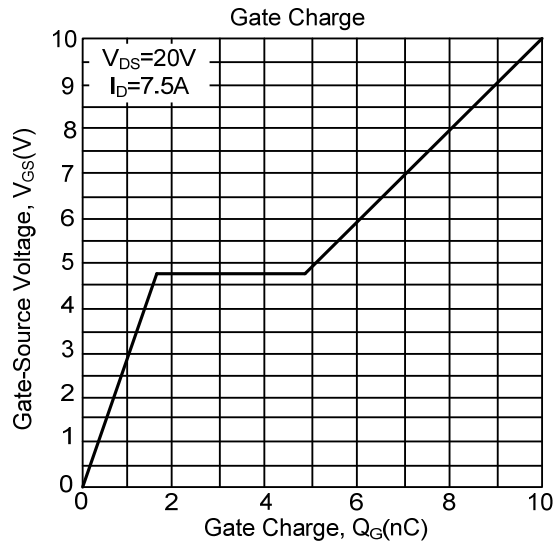
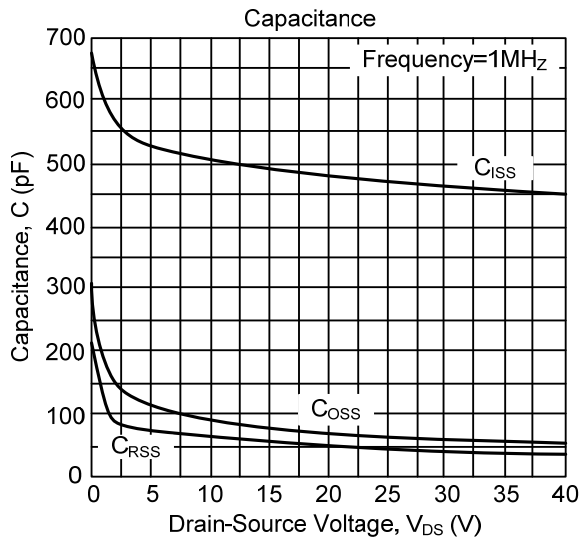

P-CHANNEL

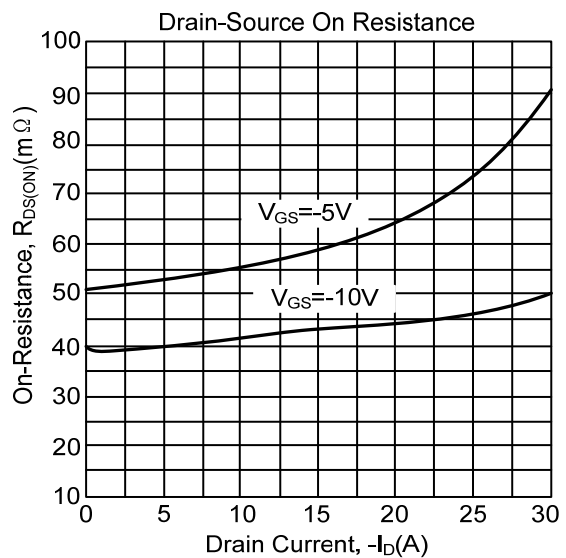
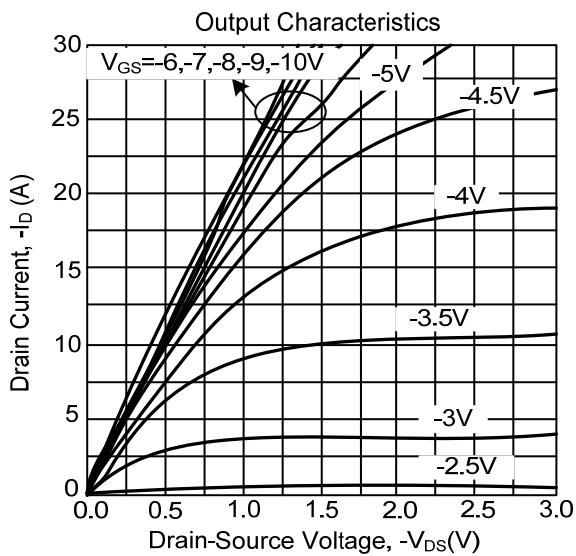
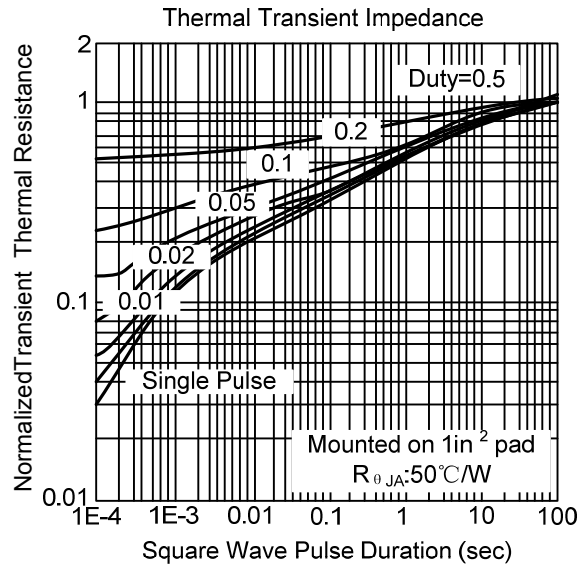
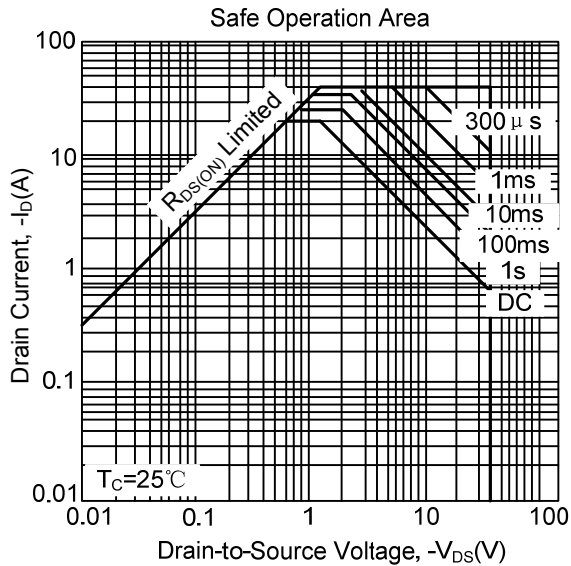

TYPICAL CHARACTERISTICS(Cont.)

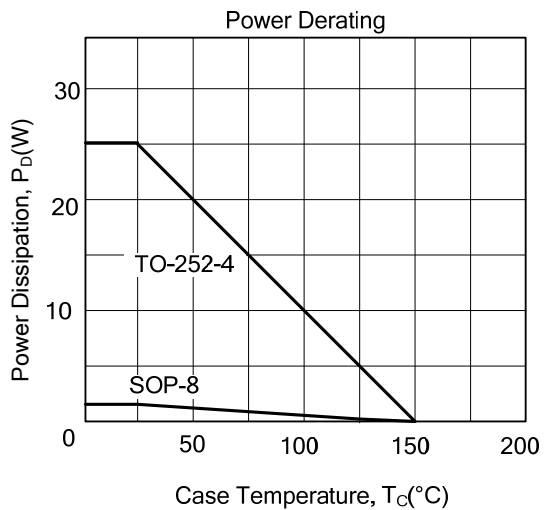
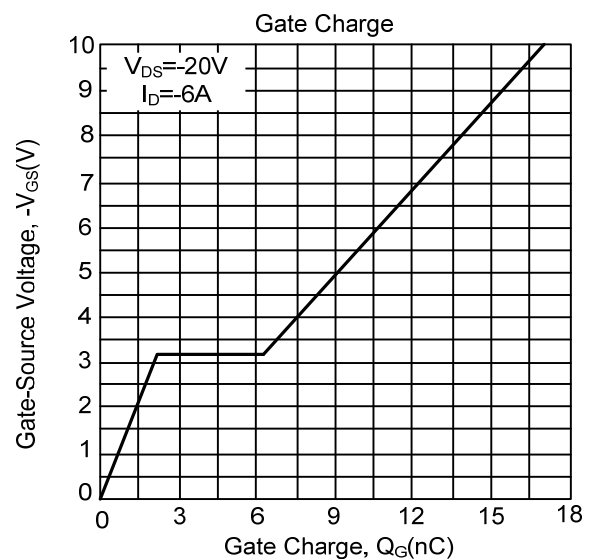
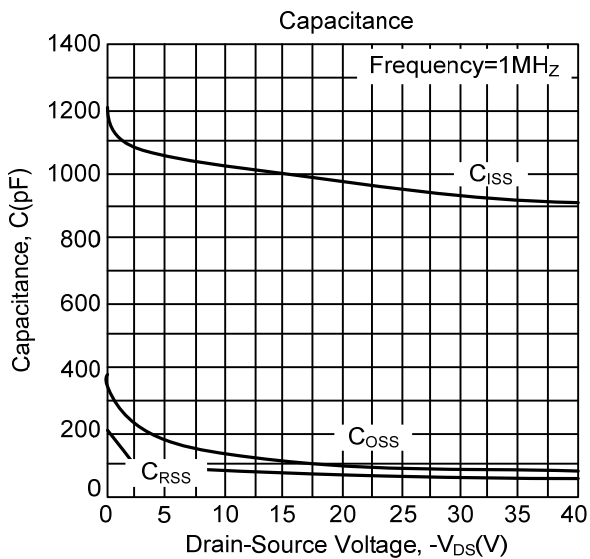
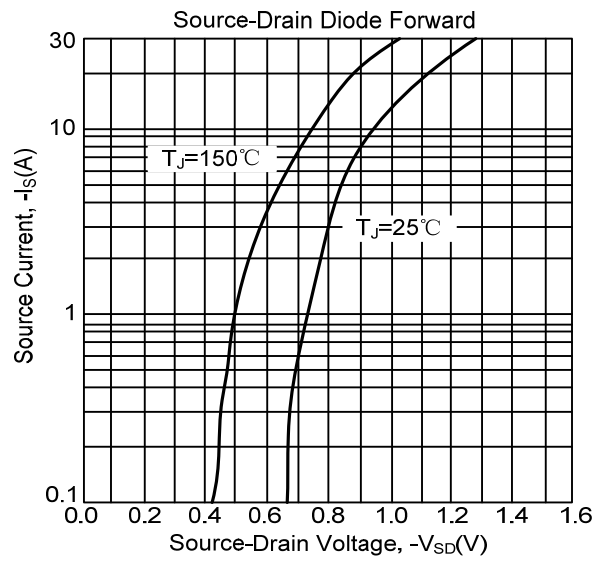
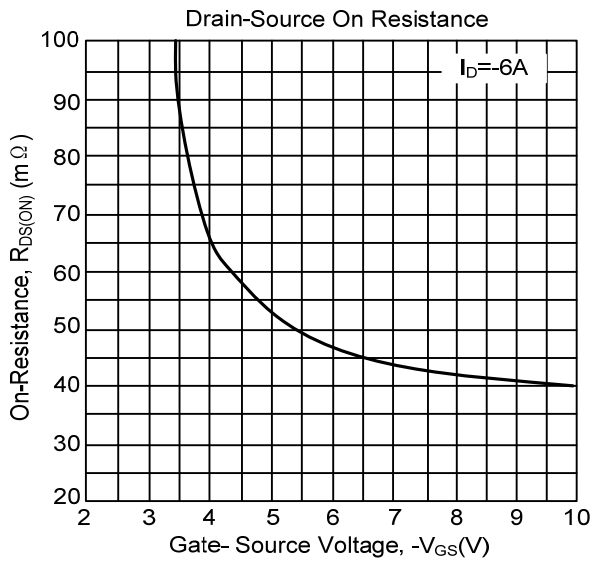

UTC assumes no responsibility for equipment failures that result from using products at values that exceed, even momentarily, rated values (such as maximum ratings, operating condition ranges, or other parameters) listed in products specifications of any and all UTC products described or contained herein. UTC products are not designed for use in life support appliances, devices or systems where malfunction of these products can be reasonably expected to result in personal injury. Reproduction in whole or in part is prohibited without the prior written consent of the copyright owner. The information presented in this document does not form part of any quotation or contract, is believed to be accurate and reliable and may be changed without notice.