



Frontier Electronics Corp.

667 E. COCHRAN STREET, SIMI VALLEY, CA 93065

TEL: (805) 522-9998 FAX: (805) 522-9989

E-mail: frontiersales@frontierusa.com

Web: <http://www.frontierusa.com>

5A ULTRA FAST RECOVERY RECTIFIER

HER501-LFR THRU HER508-LFR

FEATURES

- PLASTIC PACKAGE HAS UNDERWRITERS LABORATORY FLAMMABILITY CLASSIFICATION 94V-0
- ULTRA FAST RECOVERY TIMES FOR HIGH EFFICIENCY
- LOW FORWARD VOLTAGE, HIGH CURRENT CAPABILITY
- LOW LEAKAGE
- HIGH SURGE CAPABILITY
- HIGH TEMPERATURE SOLDERING GUARANTEED:
260°C 0.375" (9.5mm) LEAD LENGTHS FOR 10 SECONDS AT 5 LBS. (2.3 KG) TENSION.
- ROHS

MECHANICAL DATA

- CASE: JEDEC DO-201AD, MOLDED PLASTIC, DIMENSIONS IN INCHES AND (MILLIMETERS)
- TERMINALS: AXIAL LEADS SOLDERABLE PER MIL-STD-202, METHOD 208
- POLARITY: COLOR BAND DENOTES CATHODE END
- MOUNTING: POSITION: ANY
- WEIGHT: 1.2 GRAM

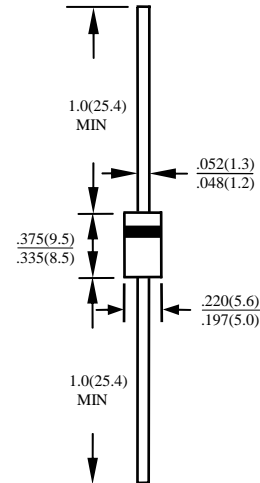

MAXIMUM RATINGS AND ELECTRICAL CHARACTERISTICS RATINGS AT 25°C AMBIENT TEMPERATURE UNLESS OTHERWISE SPECIFIED SINGLE PHASE, HALF WAVE, 60 HZ, RESISTIVE OR INDUCTIVE LOAD. FOR CAPACITIVE LOAD, DERATE CURRENT BY 20%

RATINGS	SYMBOL	HER501 -LFR	HER502 -LFR	HER503 -LFR	HER504 -LFR	HER505 -LFR	HER506 -LFR	HER507 -LFR	HER508 -LFR	UNITS	
MAXIMUM RECURRENT PEAK REVERSE VOLTAGE	V_{RRM}	50	100	200	300	400	600	800	1000	V	
MAXIMUM RMS VOLTAGE	V_{RMS}	35	70	140	210	280	420	560	700	V	
MAXIMUM DC BLOCKING VOLTAGE	V_{DC}	50	100	200	300	400	600	800	1000	V	
MAXIMUM AVERAGE FORWARD RECTIFIED CURRENT 0.375" (9.5mm) LEAD LENGTH AT $T_A=50^\circ\text{C}$	I_O	5.0								A	
PEAK FORWARD SURGE CURRENT 8.3ms SINGLE HALF SINE-WAVE SUPERIMPOSED ON RATED LOAD	I_{FSM}	200								A	
TYPICAL JUNCTION CAPACITANCE (NOTE 1)	C_J	70					50				PF
TYPICAL THERMAL RESISTANCE (NOTE 2)	$R_{\theta ja}$	15								$^\circ\text{C/W}$	
STORAGE TEMPERATURE RANGE	T_{STG}	-55 TO + 150								$^\circ\text{C}$	
OPERATING TEMPERATURE RANGE	T_{OP}	-55 TO + 150								$^\circ\text{C}$	

ELECTRICAL CHARACTERISTICS (AT $T_A = 25^\circ\text{C}$ UNLESS OTHERWISE NOTED)

CHARACTERISTICS	SYMBOL	HER501 -LFR	HER502 -LFR	HER503 -LFR	HER504 -LFR	HER505 -LFR	HER506 -LFR	HER507 -LFR	HER508 -LFR	UNITS	
MAXIMUM FORWARD VOLTAGE AT I_O DC	V_F	1.3					1.85				V
MAXIMUM REVERSE CURRENT AT $T_A=25^\circ$	I_R	10									μA
MAXIMUM REVERSE CURRENT AT $T_A=100^\circ$	I_R	100									μA
MAXIMUM REVERSE RECOVERY TIME (NOTE 3)	T_{RR}	50					75				nS

- NOTE :
1. MEASURED AT 1 MHZ AND APPLIED REVERSE VOLTAGE OF 4.0 VOLTS
 2. BOTH LEADS ATTACHED TO HEAT SINK 63.5×63.5×1t(mm) COPPER PLATE AT LEAD LENGTH 5mm
 3. REVERSE RECOVERY TEST CONDITIONS: $I_F=0.5\text{A}$, $I_R=1.0\text{A}$, $I_{RR}=0.25\text{A}$

RATINGS AND CHARACTERISTIC CURVE HER501-LFR THRU HER508-LFR

FIG. 1-TEST CIRCUIT DIAGRAM AND REVERSE RECOVERY TIME CHARACTERISTIC

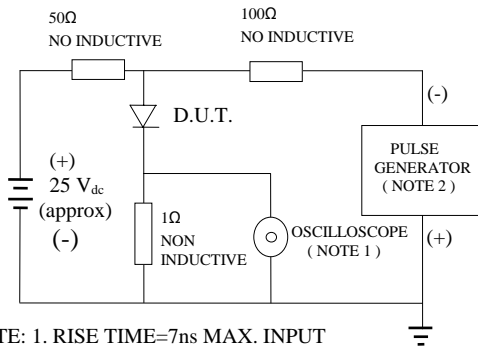

NOTE: 1. RISE TIME=7ns MAX. INPUT IMPEDANCE=1 MOhms 22PF
 2. RISE TIME =10ns MAX. SOURCE IMPEDANCE=50 OHMS

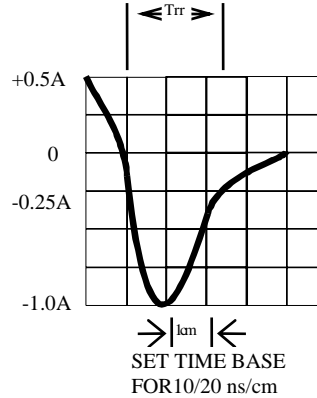

FIG. 2-TYPICAL FORWARD CURRENT DERATING CURVE

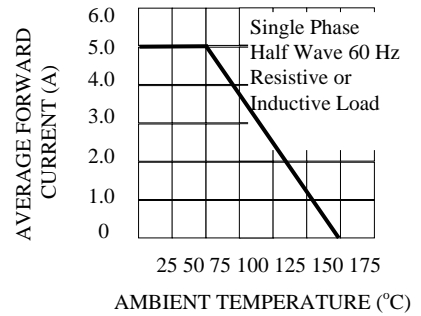

FIG. 3-TYPICAL REVERSE CHARACTERISTICS

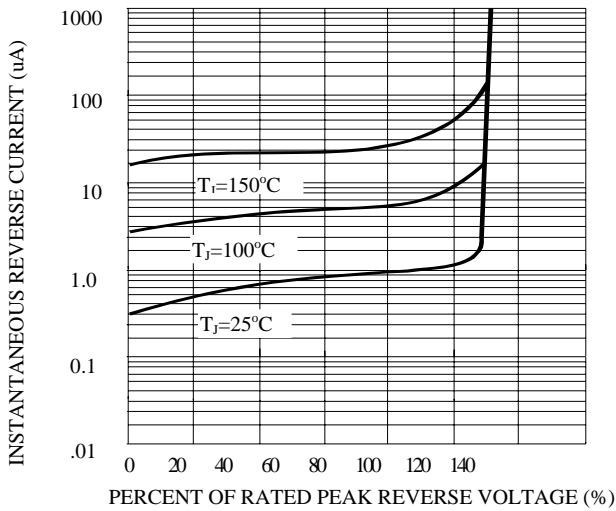

FIG. 4-TYPICAL INSTANTANEOUS FORWARD CHARACTERISTICS

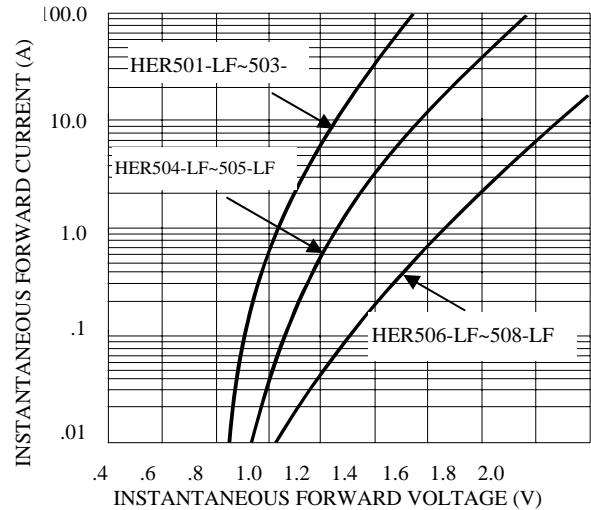

FIG. 5-MAXIMUM NON-REPETITIVE FORWARD SURGE CURRENT

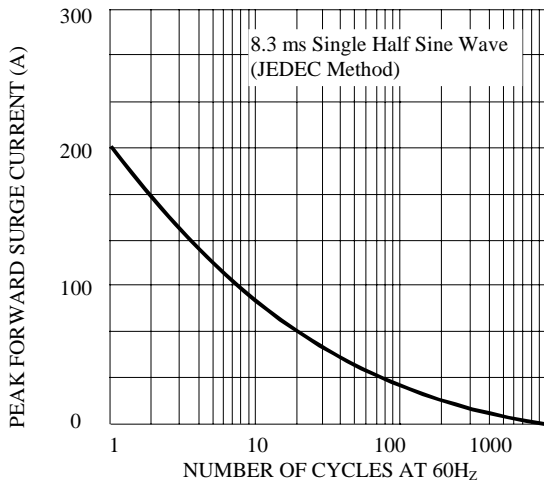

FIG. 6-TYPICAL JUNCTION CAPACITANCE

